

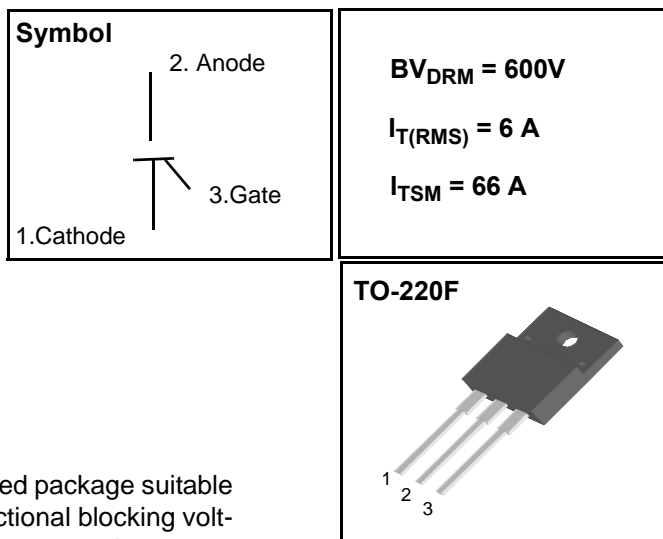
## Standard Gate Silicon Controlled - Rectifiers

### Features

Repetitive Peak Off-State Voltage : 600V  
R.M.S On-State Current (  $I_{T(RMS)} = 10\text{ A}$  )  
Low On-State Voltage (1.4V(Typ.)@  $I_{TM}$ )  
Isolation Voltage (  $V_{ISO} = 2500\text{V AC}$  )

### General Description

Standard gate triggering thyristor is fully isolated package suitable for the application where requiring high bidirectional blocking voltage capability and also suitable for over voltage protection ,motor control circuit in power tool, inrush current limit circuit and heating control system.



### Absolute Maximum Ratings ( $T_J = 25^\circ\text{C}$ unless otherwise specified )

Symbol	Parameter	Condition	Ratings	Units
$V_{DRM}$	Repetitive Peak Off-State Voltage	sine wave,50 to 60Hz,gate open	600	V
$I_{T(AV)}$	Average On-State Current	half sine wave : $T_C = 86^\circ\text{C}$	6.4	A
$I_{T(RMS)}$	R.M.S On-State Current	180° Conduction Angle	10	A
$I_{TSM}$	Surge On-State Current	1/2 Cycle, 60Hz, Sine Wave Non-Repetitive	110	A
$I^2t$	$I^2t$ for Fusing	$t = 8.3\text{ms}$	60	$\text{A}^2\text{s}$
$di/dt$	Critical rate of rise of on-state current		50	$\text{A}/\mu\text{s}$
$P_{GM}$	Forward Peak Gate Power Dissipation	$T_C = 106^\circ\text{C}$ , pulse width $1.0\mu\text{s}$	5	W
$P_{G(AV)}$	Forward Average Gate Power Dissipation	$T_C = 106^\circ\text{C}$ ,pulse width $1.0\mu\text{s}$	0.5	W
$I_{FGM}$	Forward Peak Gate Current	$T_C = 106^\circ\text{C}$ , pulse width $1.0\mu\text{s}$	2	A
$V_{RGM}$	Reverse Peak Gate Voltage	$T_C = 106^\circ\text{C}$ , pulse width $1.0\mu\text{s}$	5.0	V
$V_{ISO}$	Isolation Breakdown Voltage(R.M.S.)	A.C. 1 minute	2500	V
$T_J$	Operating Junction Temperature		- 40 ~ 125	$^\circ\text{C}$
$T_{STG}$	Storage Temperature		- 40 ~ 150	$^\circ\text{C}$

# DCF10C60

## Electrical Characteristics ( $T_C = 25\text{ }^\circ\text{C}$ unless otherwise noted )

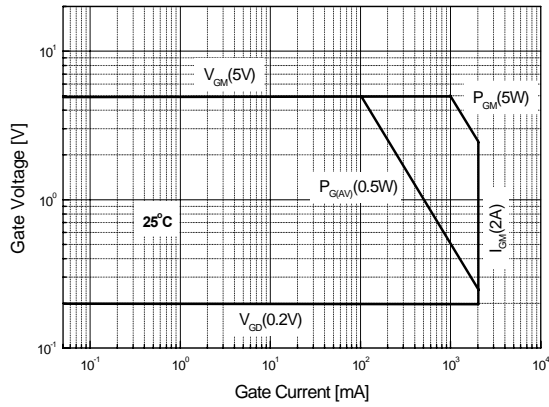
Symbol	Items	Conditions	Ratings			Unit
			Min.	Typ.	Max.	
$I_{\text{DRM}}$	Repetitive Peak Off-State Current	$V_{\text{AK}} = V_{\text{DRM}}$ $T_C = 25\text{ }^\circ\text{C}$ $T_C = 125\text{ }^\circ\text{C}$			10 200	$\mu\text{A}$
$V_{\text{TM}}$	Peak On-State Voltage (1)	$I_{\text{TM}} = 20\text{ A}$ $t_p = 380\text{ }\mu\text{s}$			1.6	V
$I_{\text{GT}}$	Gate Trigger Current (2)	$V_{\text{AK}} = 6\text{ V(DC)}$ , $R_L = 10$ $T_C = 25\text{ }^\circ\text{C}$			15	mA
$V_{\text{GT}}$	Gate Trigger Voltage (2)	$V_D = 6\text{ V(DC)}$ , $R_L = 10$ $T_C = 25\text{ }^\circ\text{C}$			1.5	V
$V_{\text{GD}}$	Non-Trigger Gate Voltage (1)	$V_{\text{AK}} = 12\text{ V}$ , $R_L = 100$ $T_C = 125\text{ }^\circ\text{C}$	0.2			V
dv/dt	Critical Rate of Rise Off-State Voltage	Linear slope up to $V_D = V_{\text{DRM}} 67\%$ , Gate open $T_J = 125\text{ }^\circ\text{C}$	200			V/ $\mu\text{s}$
$I_{\text{H}}$	Holding Current	$I_T = 100\text{ mA}$ , Gate Open $T_C = 25\text{ }^\circ\text{C}$			20	mA
$R_{\text{th(j-c)}}$	Thermal Impedance	Junction to case			3.8	$^\circ\text{C/W}$
$R_{\text{th(j-a)}}$	Thermal Impedance	Junction to Ambient			60	$^\circ\text{C/W}$

### Notes :

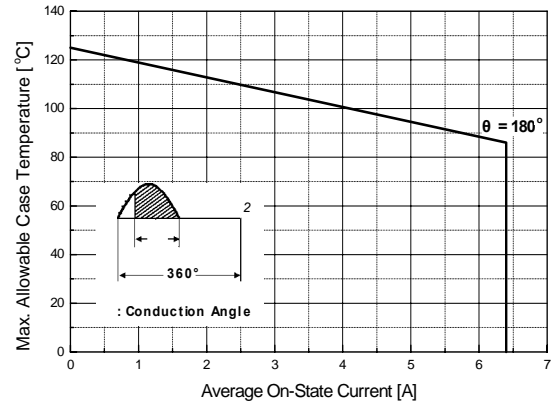
1. Pulse Width 1.0 ms , Duty cycle 1%
2.  $R_{\text{GK}}$  Current not Included in measurement.

# DCF10C60

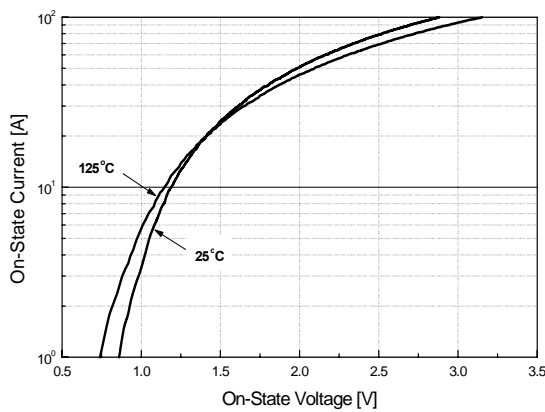
**Fig 1. Gate Characteristics**



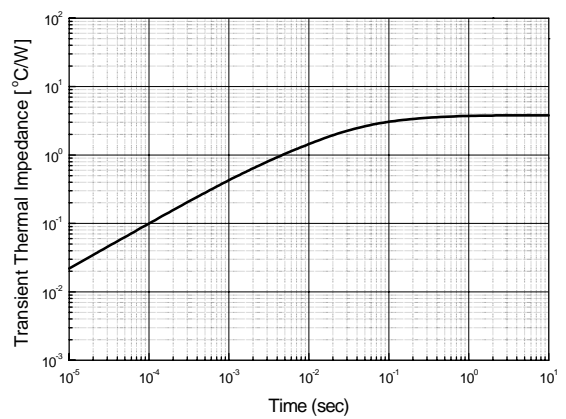
**Fig 2. Maximum Case Temperature**



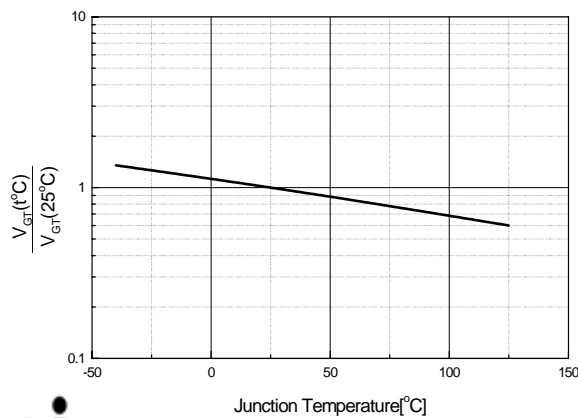
**Fig 3. Typical Forward Voltage**



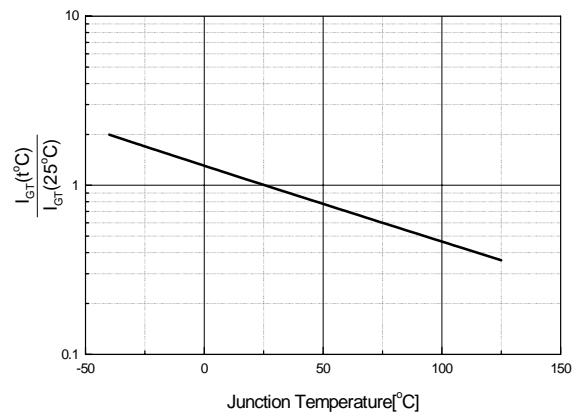
**Fig 4. Thermal Response**



**Fig 5. Typical Gate Trigger Voltage vs. Junction Temperature**

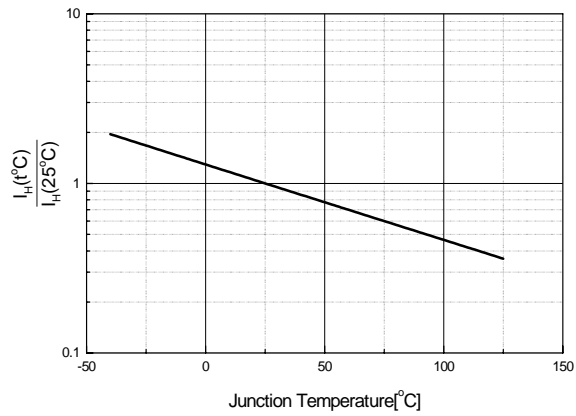


**Fig 6. Typical Gate Trigger Current vs. Junction Temperature**

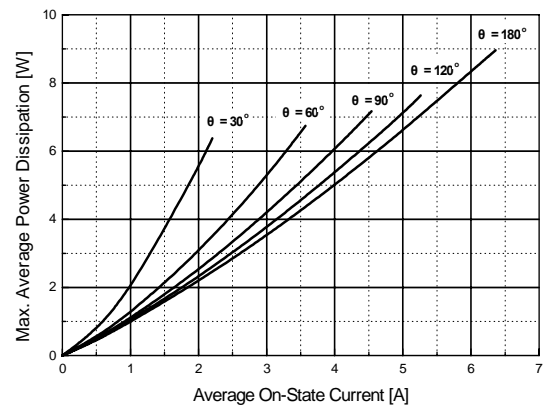


# DCF10C60

**Fig 7. Typical Holding Current**



**Fig 8. Power Dissipation**



# DCF10C60

## TO-220F Package Dimension

Dim.	mm			Inch		
	Min.	Typ.	Max.	Min.	Typ.	Max.
A	10.4		10.6	0.409		0.417
B	6.18		6.44	0.243		0.254
C	9.55		9.81	0.376		0.386
D	13.47		13.73	0.530		0.540
E	6.05		6.15	0.238		0.242
F	1.26		1.36	0.050		0.054
G	3.17		3.43	0.125		0.135
H	1.87		2.13	0.074		0.084
I	2.57		2.83	0.101		0.111
J		2.54			0.100	
K		5.08			0.200	
L	2.51		2.62	0.099		0.103
M	1.25		1.55	0.049		0.061
N	0.45		0.63	0.018		0.025
O	0.6		1.0	0.024		0.039
		3.7			0.146	
1		3.2			0.126	
2		1.5			0.059	

