



PD54003 PD54003S

RF POWER TRANSISTORS The LdmoST FAMILY

ADVANCE DATA

N-CHANNEL ENHANCEMENT-MODE LATERAL MOSFETs

- EXCELLENT THERMAL STABILITY
- COMMON SOURCE CONFIGURATION
- $P_{OUT} = 3\text{ W}$ WITH 12 dB gain @ 500 MHz
- NEW RF PLASTIC PACKAGE

DESCRIPTION

The PD54003 is a common source N-Channel, enhancement-mode lateral Field-Effect RF power transistor. It is designed for high gain, broad band commercial and industrial applications. It operates at 7 V in common source mode at frequencies of up to 1 GHz. PD54003 boasts the excellent gain, linearity and reliability of ST's latest LDMOS technology mounted in the first true SMD plastic RF power package, PowerSO-10RF. PD54003's superior linearity performance makes it an ideal solution for portable radio.

The PowerSO-10 plastic package, designed to offer high reliability, is the first ST JEDEC approved, high power SMD package. It has been specially optimized for RF needs and offers excellent RF performances and ease of assembly.

Mounting recommendations are available in www.st.com/rf/ (look for application note AN1294)

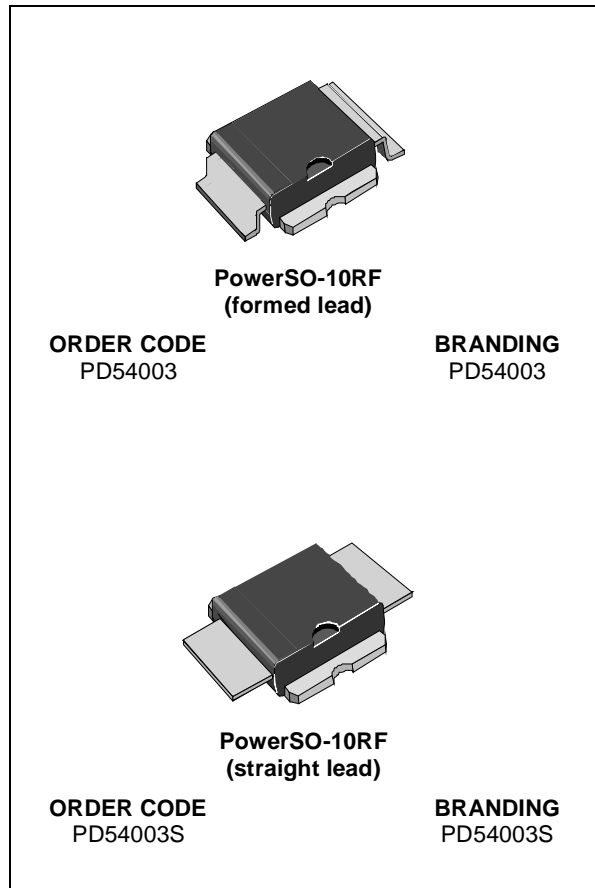

ABSOLUTE MAXIMUM RATINGS ($T_{CASE} = 25^{\circ}\text{C}$)

Symbol	Parameter	Value	Unit
$V_{(BR)DSS}$	Drain-Source Voltage	25	V
V_{GS}	Gate-Source Voltage	± 20	V
I_D	Drain Current	4	A
P_{DISS}	Power Dissipation (@ $T_c = 70^{\circ}\text{C}$)	52.8	W
T_j	Max. Operating Junction Temperature	165	$^{\circ}\text{C}$
T_{STG}	Storage Temperature	-65 to +150	$^{\circ}\text{C}$

THERMAL DATA

$R_{th(j-c)}$	Junction -Case Thermal Resistance	1.8	$^{\circ}\text{C}/\text{W}$
---------------	-----------------------------------	-----	-----------------------------

PD54003 - PD54003S

ELECTRICAL SPECIFICATION (T_{CASE} = 25°C)

STATIC (Per Section)

Symbol	Test Conditions		Min.	Typ.	Max.	Unit
I _{DSS}	V _{GS} = 0 V	V _{DS} = 25 V			1	μA
I _{GSS}	V _{GS} = 20 V	V _{DS} = 0 V			1	μA
V _{GS(Q)}	V _{DS} = 10 V	I _D = 50 mA	2.0		5.0	V
V _{DS(ON)}	V _{GS} = 10 V	I _D = 1 A			1.3	V
g _{FS}	V _{DS} = 10 V	I _D = 3.2 A		1.7		mho
C _{ISS}	V _{GS} = 0 V	V _{DS} = 7.5 V		59		pF
C _{OSS}	V _{GS} = 0 V	V _{DS} = 7.5 V		43		pF
C _{RSS}	V _{GS} = 0 V	V _{DS} = 7.5 V		4.0		pF

DYNAMIC

Symbol	Test Conditions		Min.	Typ.	Max.	Unit
P _{OUT}	V _{DD} = 7.5 V	I _{DQ} = 50 mA	f = 500 MHz	3		W
G _{PS}	V _{DD} = 7.5 V	I _{DQ} = 50 mA	P _{OUT} = 3 W	10	12	dB
η _D	V _{DD} = 7.5 V	I _{DQ} = 50 mA	P _{OUT} = 3 W	50	55	%
Load mismatch	V _{DD} = 9.5 V	I _{DQ} = 50 mA	P _{OUT} = 3 W	20:1		VSWR
	ALL PHASE ANGLES					

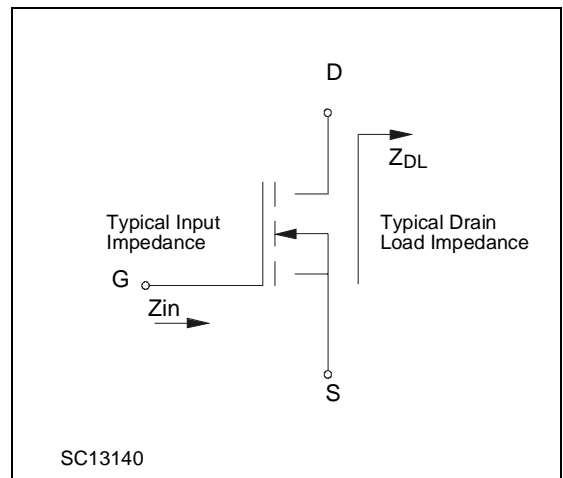
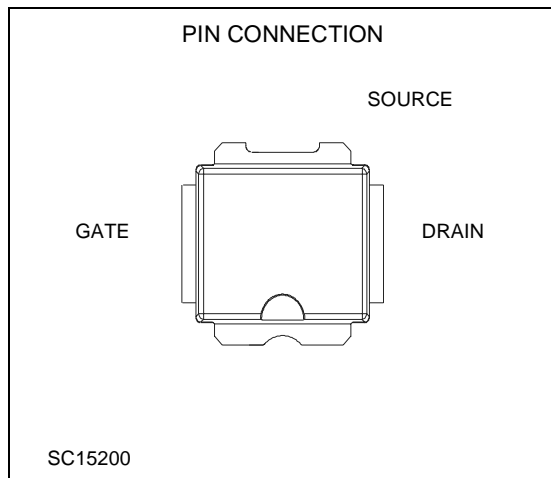

IMPEDANCE DATA

PD54003

FREQ. MHz	Z _{IN} (Ω)	Z _{DL} (Ω)
480	2.245 - j 0.077	3.436 + j 1.013
500	1.553 - j 1.251	2.661 + j 0.139
520	1.993 - j 1.098	2.564 + j 0.656

PD54003S

FREQ. MHz	Z _{IN} (Ω)	Z _{DL} (Ω)
480	1.400 - j 3.986	2.805 + j 2.724
500	1.209 - j 2.451	3.192 + j 3.147
520	1.534 - j 2.104	2.524 + j 2.369

TYPICAL PERFORMANCE

Capacitance vs. Drain Voltage

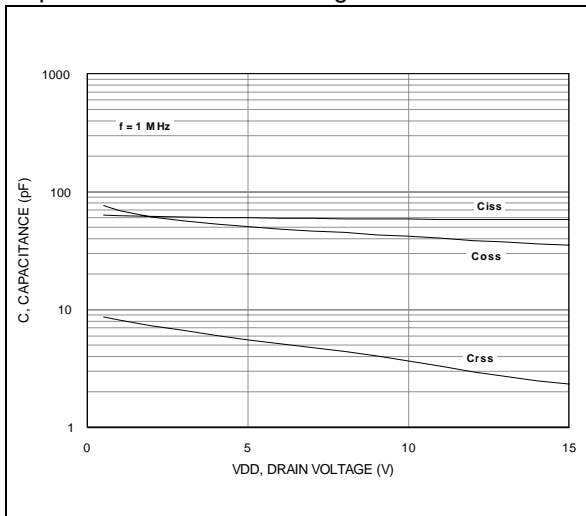

Drain Current vs. Gate Voltage

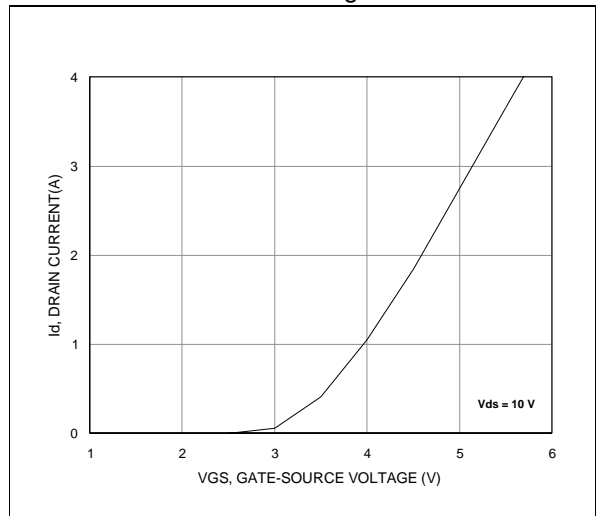

Gate-Source Voltage vs. Case Temperature

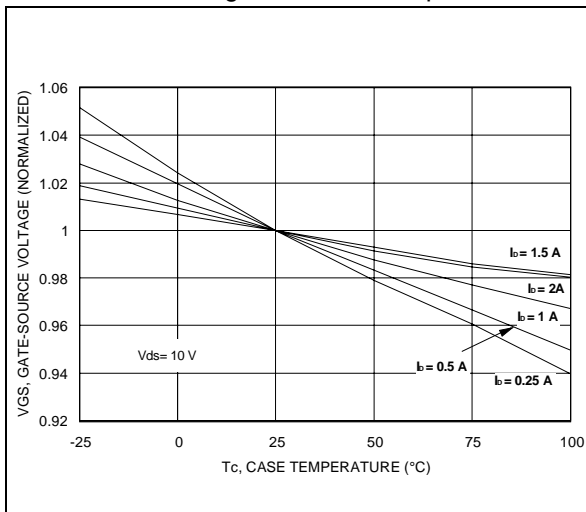

PD54003 - PD54003S

TYPICAL PERFORMANCE

PD54003

Output Power vs. Input Power

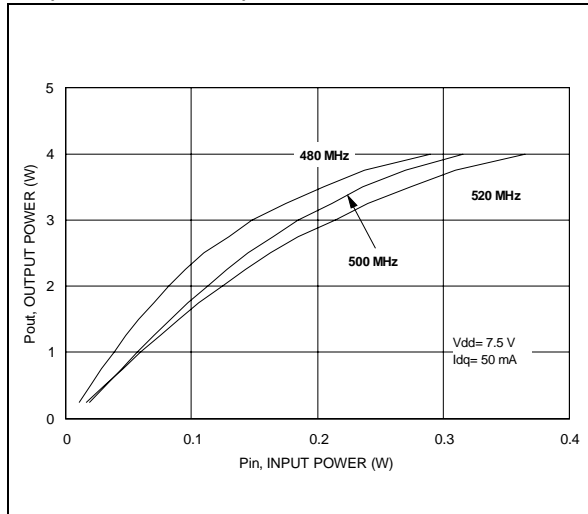

Power Gain vs. Output Power

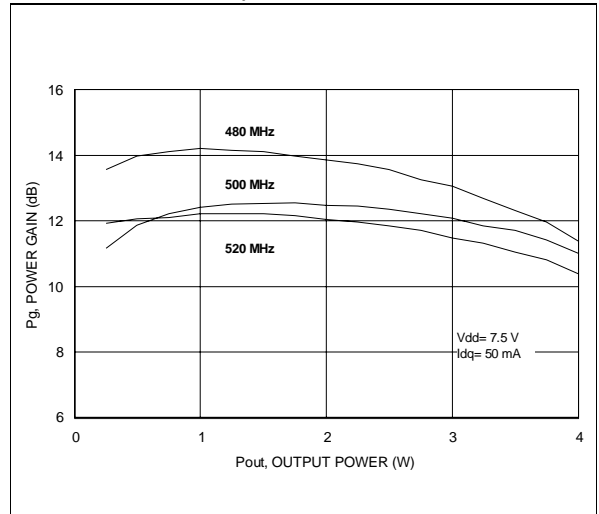

Drain Efficiency vs. Output Power

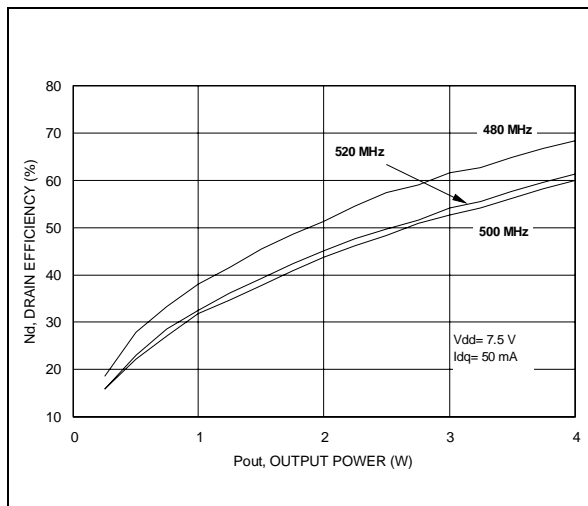

Return Loss vs. Output Power

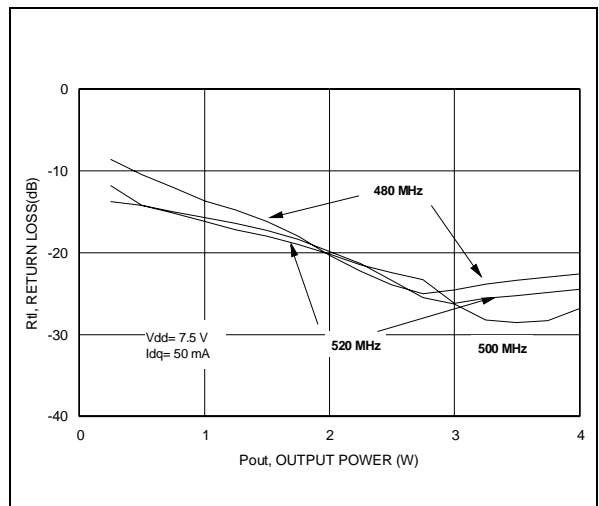

Output Power vs. Bias Current

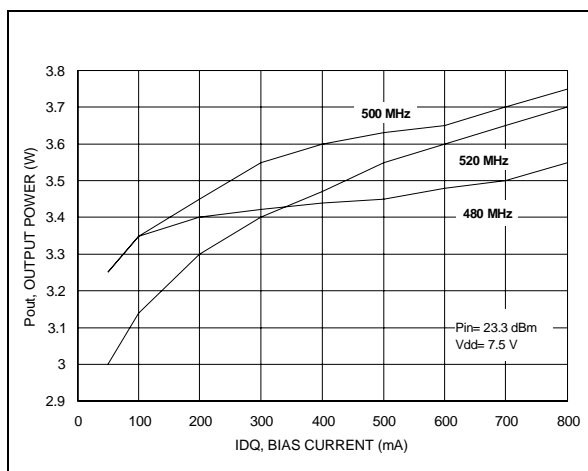

Drain Efficiency vs. Bias Current

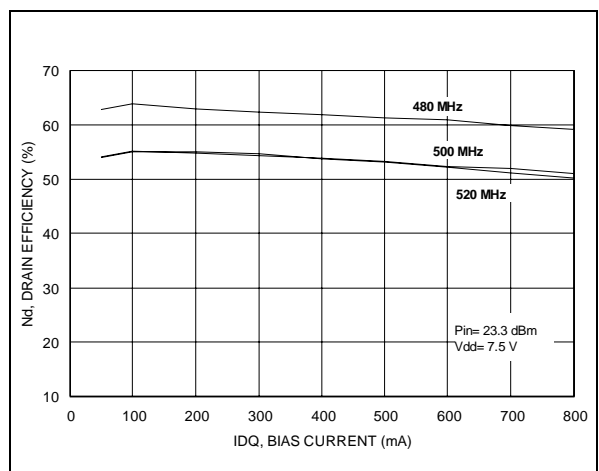

TYPICAL PERFORMANCE

Output Power vs. Supply Voltage

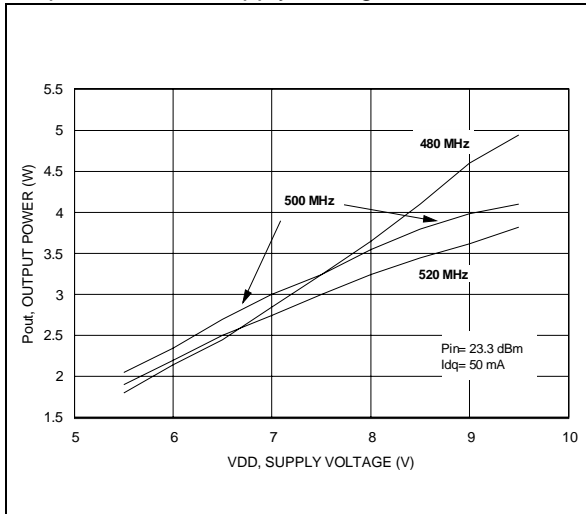

Drain Efficiency vs. Supply Voltage

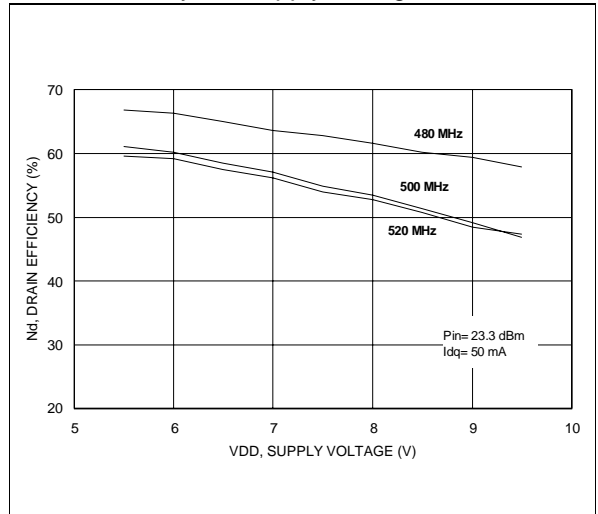

Output Power vs. Gate-Source Voltage

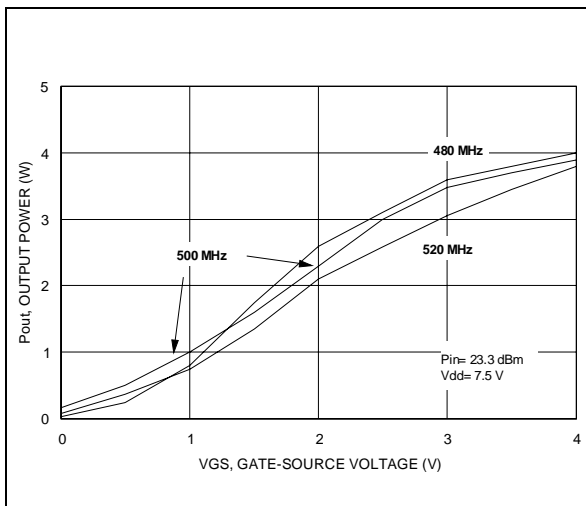

PD54003 - PD54003S

TYPICAL PERFORMANCE

Output Power vs. Input Power

PD54003S

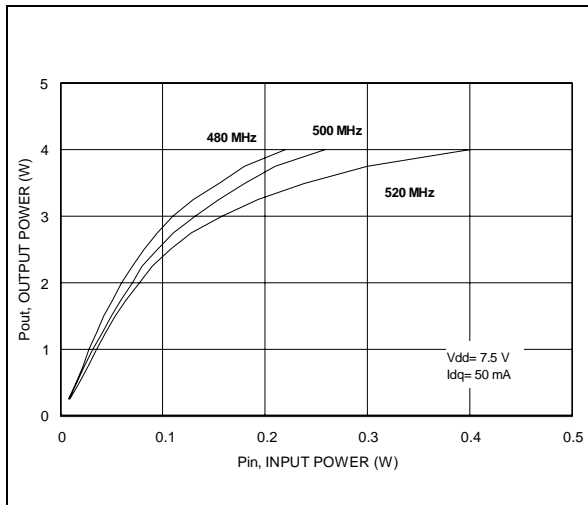

Power Gain vs. Output Power

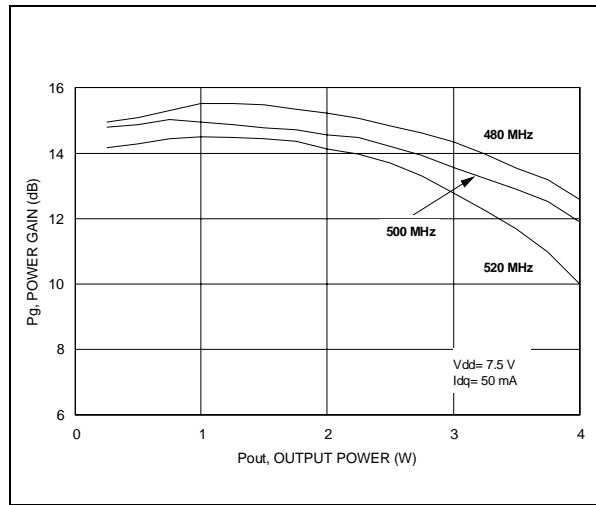

Drain Efficiency vs. Output Power

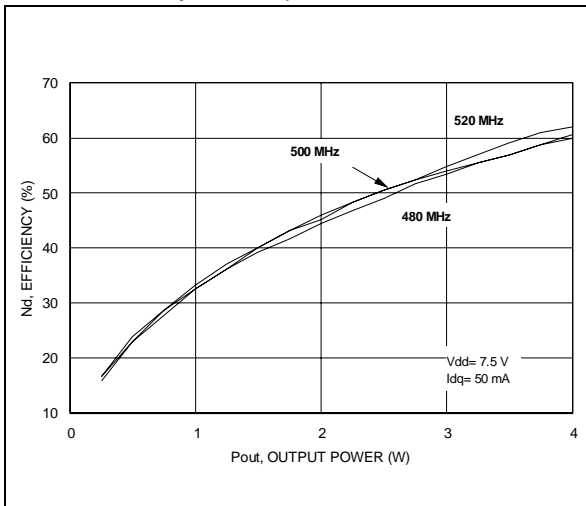

Return Loss vs. Output Power

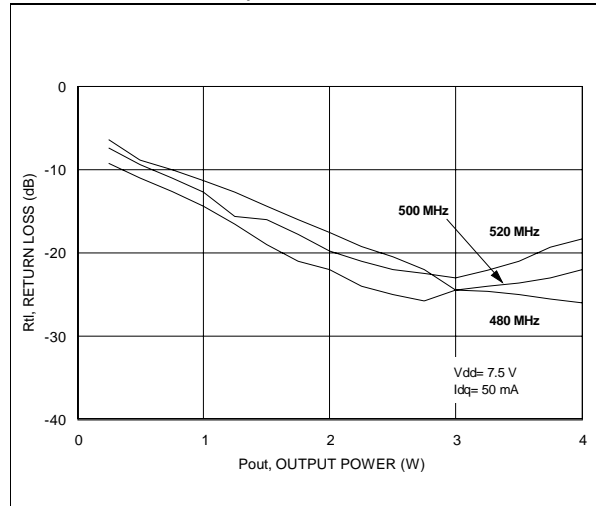

Output Power vs. Bias Current

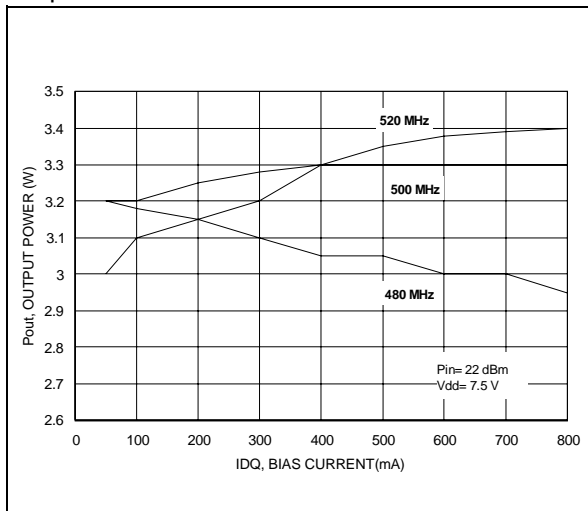

Drain Efficiency vs. Bias Current

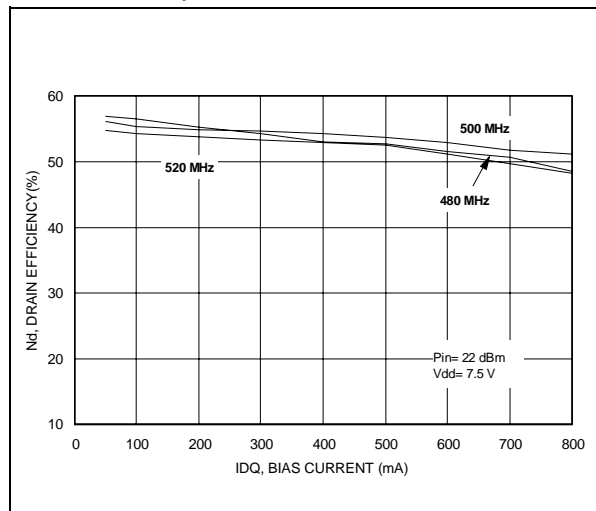

TYPICAL PERFORMANCE

Output Power vs. Supply Voltage

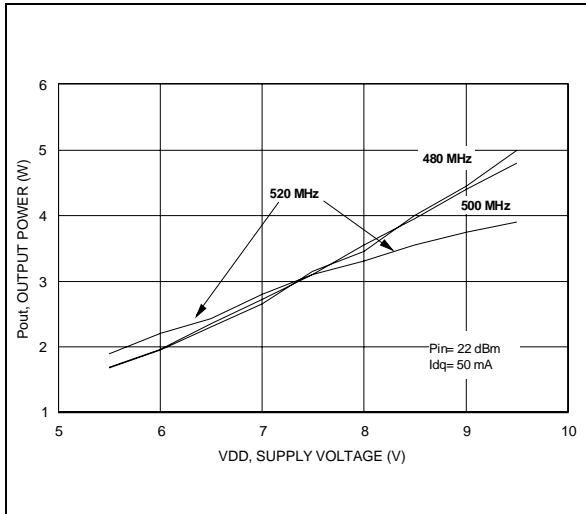

Drain Efficiency vs. Supply Voltage

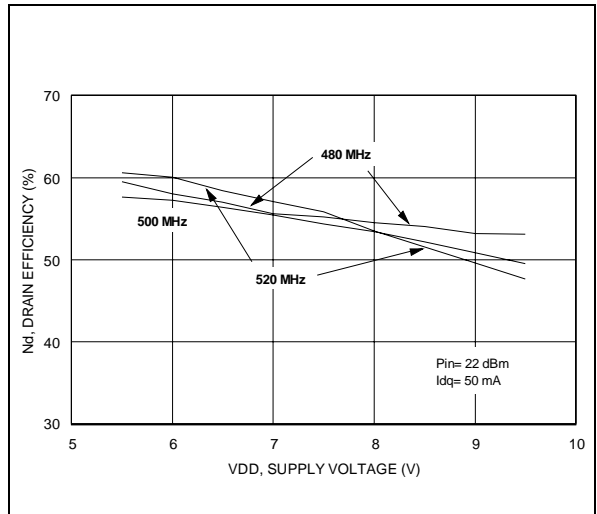

Output Power vs. Gate-Source Voltage

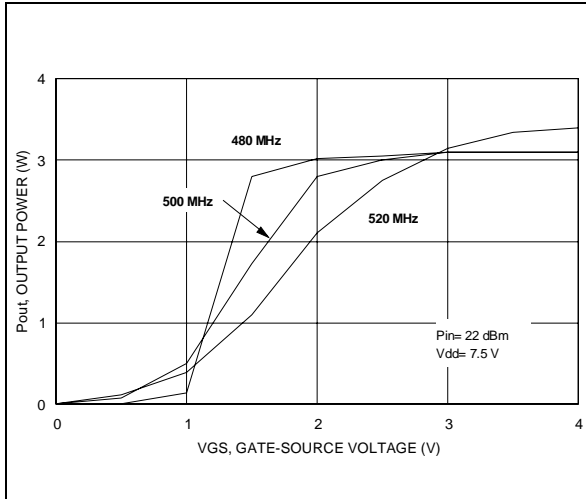

TEST CIRCUIT SCHEMATIC

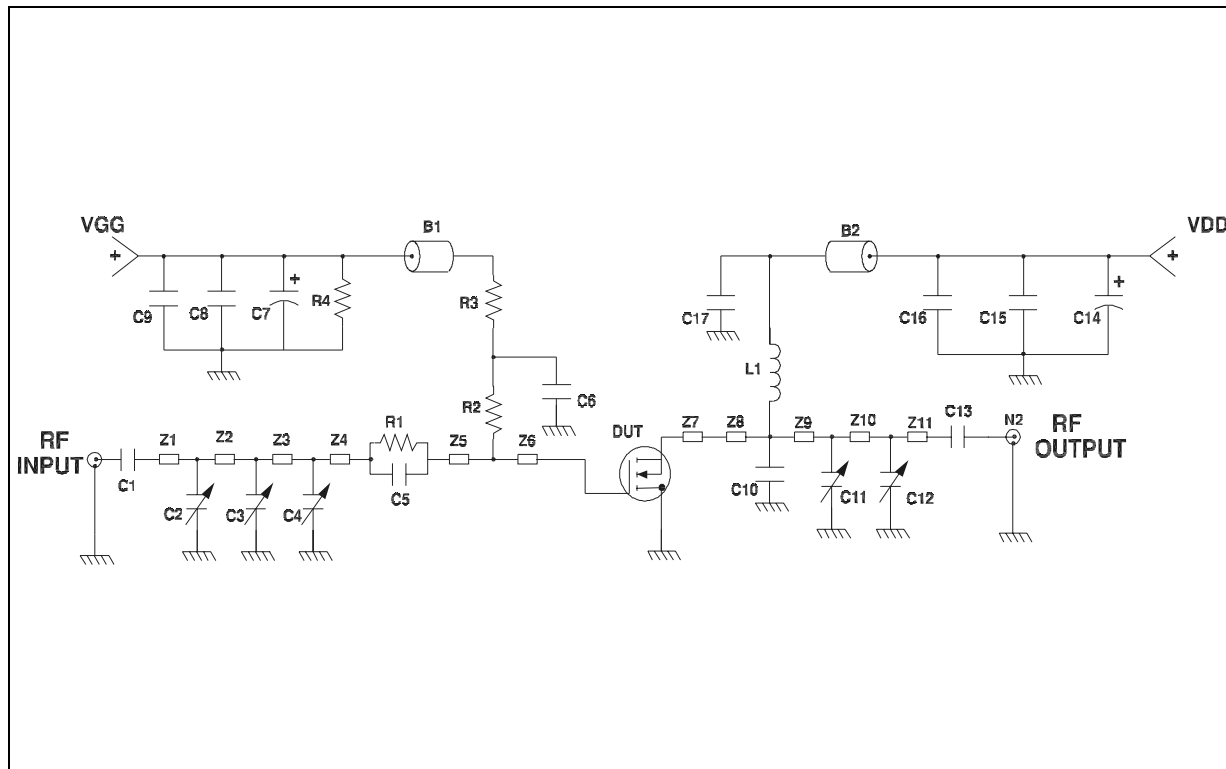

TEST CIRCUIT COMPONENT PART LIST

COMPONENT	DESCRIPTION
B1,B2	SHORT FERRITE BEAD, FAIR RITE PRODUCTS (2743021446)
C1,C13	240 pF, 100 mil CHIP CAPACITOR
C2,C3,C4,C10,C11,C12	0 TO 20 pF TRIMMER CAPACITOR
C5	130 pF, 100 mil CHIP CAPACITOR
C6,C17	120 pF, 100 mil CHIP CAPACITOR
C7,C14	10 μF, 50 V ELECTROLITIC CAPACITOR
C8,C15	1.200 pF, 100 mil CHIP CAPACITOR
C9,C16	0.1 F, 100 mil CHIP CAPACITOR
L1	55,5 Nh, 5 TURN, COILCRAFT
N1,N2	TYPE N FLANGE MOUNT
R1	15 Ω, 0805 CHIP RESISTOR
R2	1.0 KΩ, 1/8 W RESISTOR
R3	15 Ω, 0805 CHIP RESISTOR
R4	33 KΩ, 1/8 W RESISTOR
Z1	0.175" X 0.080" MICROSTRIP
Z2	1.049" X 0.080" MICROSTRIP
Z3	0.289" X 0.080" MICROSTRIP
Z4	0.026" X 0.080" MICROSTRIP
Z5	0.192" X 0.223" MICROSTRIP
Z6,Z7	0.260" X 0.223" MICROSTRIP
Z8	0.064" X 0.080" MICROSTRIP
Z9	0.334" X 0.080" MICROSTRIP
Z10	0.985" X 0.080" MICROSTRIP
Z11	0.472" X 0.080" MICROSTRIP
BOARD	ROGER, ULTRA LAM 2000 THK 0.030", ε _r = 2.55 2oz. ED cu 2 SIDES.

TEST CIRCUIT

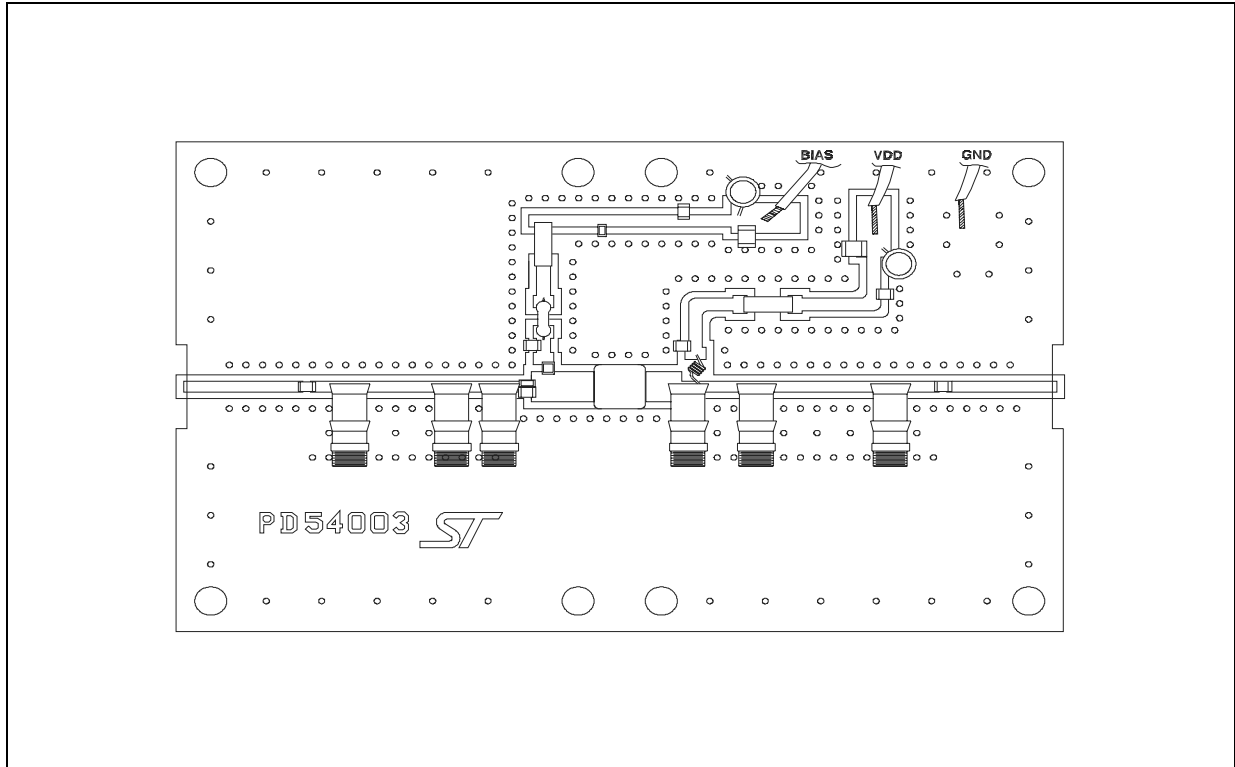

TEST CIRCUIT PHOTOMASTER

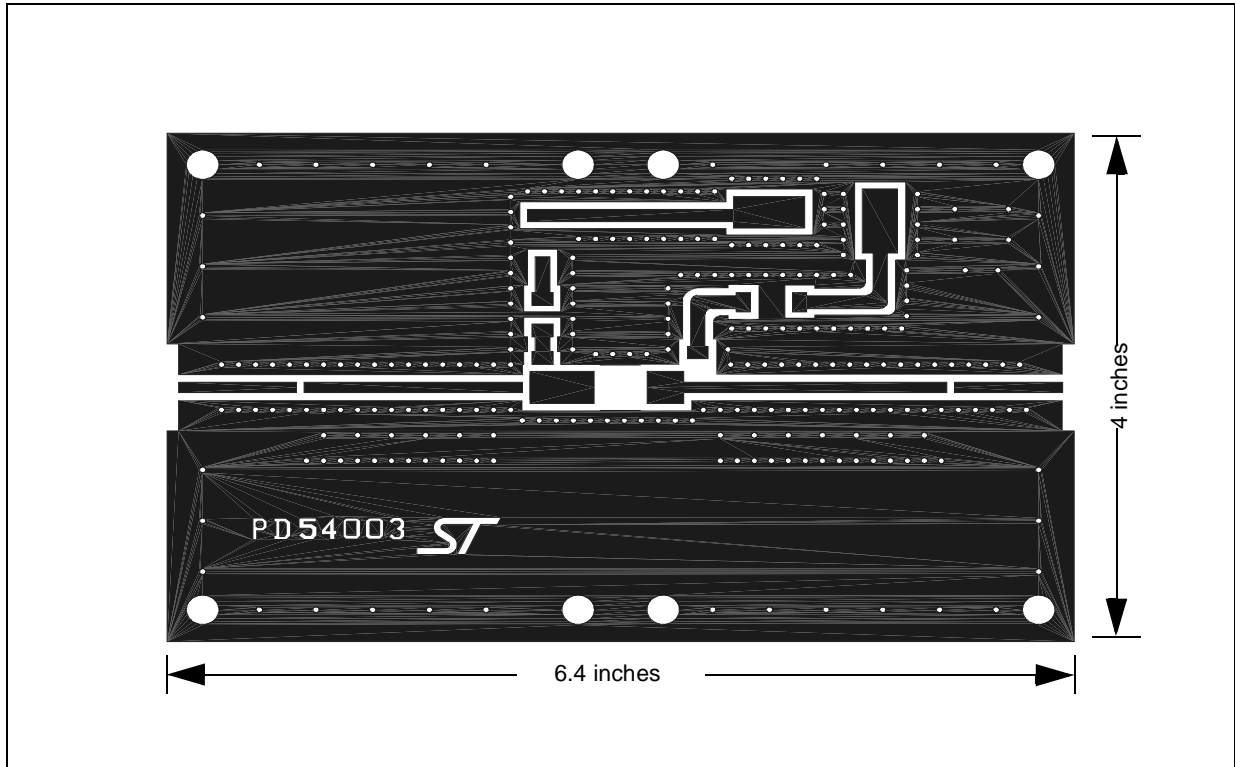

PD54003 - PD54003S**COMMON SOURCE S-PARAMETER (PD54003)** $(V_{DS} = 7.5V \quad I_{DS} = 50mA)$

FREQ (MHz)	$ S_{11} $	$\angle S_{11}$	$ S_{21} $	$\angle S_{21}$	$ S_{12} $	$\angle S_{12}$	$ S_{22} $	$\angle S_{22}$
50	0.729	-127	10.26	94	0.058	5	0.702	-122
100	0.759	-146	4.91	72	0.056	-15	0.706	-141
150	0.807	-154	3.02	59	0.050	-28	0.749	-149
200	0.845	-159	2.06	48	0.044	-38	0.802	-154
250	0.844	-162	1.48	40	0.039	-45	0.839	-185
300	0.901	-165	1.12	33	0.034	-52	0.875	-162
350	0.921	-168	0.86	27	0.030	-57	0.899	-165
400	0.932	-170	0.69	22	0.027	-60	0.915	-168
450	0.944	-172	0.56	18	0.023	-64	0.935	-170
500	0.952	-173	0.47	14	0.019	-66	0.943	-172
550	0.957	-175	0.39	11	0.017	-68	0.951	-173
600	0.962	-176	0.33	8	0.014	-72	0.954	-175
650	0.967	-177	0.29	5	0.012	-70	0.958	-176
700	0.969	-178	0.25	3	0.010	-71	0.958	-178
750	0.970	-180	0.22	1	0.009	-69	0.963	-179
800	0.972	179	0.20	-1	0.008	-71	0.963	179
850	0.972	179	0.18	-2	0.007	-78	0.969	178
900	0.973	178	0.16	-4	0.004	-76	0.972	177
950	0.972	177	0.15	-5	0.002	-46	0.972	176
1000	0.975	176	0.13	-6	0.003	-42	0.973	175
1050	0.975	175	0.12	-7	0.001	14	0.968	174
1100	0.975	174	0.11	-8	0.003	29	0.966	173
1150	0.970	173	0.10	-10	0.003	51	0.967	172
1200	0.973	173	0.10	-10	0.005	65	0.965	171
1250	0.972	172	0.09	-12	0.005	62	0.966	170
1300	0.970	171	0.08	-12	0.007	67	0.963	170
1350	0.970	170	0.08	-12	0.007	67	0.959	169
1400	0.967	170	0.07	-12	0.008	73	0.962	168
1450	0.968	169	0.07	-12	0.010	64	0.953	167
1500	0.965	168	0.06	-15	0.010	76	0.950	166

COMMON SOURCE S-PARAMETER (PD54003)

($V_{DS} = 7.5V$ $I_{DS} = 500mA$)

FREQ (MHz)	$ S_{11} $	$\angle S_{11}$	$ S_{21} $	$\angle S_{21}$	$ S_{12} $	$\angle S_{12}$	$ S_{22} $	$\angle S_{22}$
50	0.779	-162	16.39	88	0.026	4	0.772	-160
100	0.810	-168	7.93	79	0.025	-7	0.768	-168
150	0.836	-171	5.18	73	0.024	-13	0.774	-171
200	0.850	-173	3.81	67	0.023	-16	0.784	-172
250	0.861	-174	2.96	60	0.022	-21	0.795	-173
300	0.871	-175	2.39	55	0.020	-24	0.815	-174
350	0.881	-176	1.97	49	0.018	-27	0.813	-174
400	0.890	-176	1.65	45	0.017	-31	0.845	-175
450	0.901	-177	1.40	40	0.016	-30	0.865	-176
500	0.908	-178	1.20	36	0.015	-34	0.876	176
550	0.915	-179	1.05	32	0.013	-32	0.886	-177
600	0.924	-179	0.92	28	0.012	-34	0.894	-178
650	0.928	180	0.81	25	0.010	-33	0.900	-179
700	0.934	179	0.72	22	0.010	-33	0.906	180
750	0.937	178	0.65	19	0.008	-29	0.912	179
800	0.939	177	0.59	17	0.007	-24	0.920	178
850	0.943	177	0.53	14	0.006	-15	0.928	177
900	0.943	176	0.48	12	0.006	-7	0.932	176
950	0.948	175	0.45	10	0.005	9	0.934	175
1000	0.950	175	0.41	7	0.005	11	0.938	174
1050	0.952	174	0.38	5	0.006	28	0.934	173
1100	0.955	173	0.35	3	0.006	33	0.937	172
1150	0.954	172	0.32	1	0.007	41	0.938	172
1200	0.954	172	0.30	0	0.007	40	0.938	171
1250	0.953	172	0.28	-3	0.008	51	0.940	170
1300	0.952	170	0.26	-4	0.008	53	0.939	169
1350	0.954	170	0.24	-5	0.010	55	0.936	168
1400	0.952	169	0.23	-6	0.011	57	0.943	167
1450	0.952	168	0.22	-7	0.011	59	0.933	167
1500	0.950	168	0.20	-8	0.010	70	0.930	166

PD54003 - PD54003S

COMMON SOURCE S-PARAMETER (PD54003)

($V_{DS} = 7.5V$ $I_{DS} = 1A$)

FREQ (MHz)	$ S_{11} $	$\angle S_{11}$	$ S_{21} $	$\angle S_{21}$	$ S_{12} $	$\angle S_{12}$	$ S_{22} $	$\angle S_{22}$
50	0.802	-166	16.70	88	0.021	0	0.793	-164
100	0.831	-170	8.10	80	0.021	-6	0.790	-171
150	0.855	-173	5.32	75	0.020	-8	0.793	-173
200	0.867	-175	3.94	69	0.019	-13	0.801	-174
250	0.876	-175	3.08	64	0.019	-16	0.807	-175
300	0.883	-177	2.52	59	0.018	-19	0.822	-176
350	0.887	-177	2.09	53	0.017	-22	0.834	-176
400	0.864	-178	1.77	49	0.015	-24	0.844	-177
450	0.903	-178	1.52	44	0.014	-23	0.864	-177
500	0.911	-179	1.32	40	0.013	-26	0.871	-178
550	0.916	-180	1.15	36	0.012	-27	0.880	-179
600	0.922	179	1.01	33	0.010	-25	0.886	-179
650	0.926	179	0.90	30	0.010	-20	0.989	180
700	0.931	178	0.81	27	0.009	-23	0.898	179
750	0.934	177	0.73	24	0.008	-15	0.903	178
800	0.938	177	0.66	21	0.007	-16	0.911	177
850	0.941	176	0.60	18	0.007	2	0.919	176
900	0.944	175	0.55	16	0.007	3	0.923	175
950	0.945	175	0.51	13	0.007	14	0.927	175
1000	0.947	174	0.47	11	0.005	29	0.930	174
1050	0.950	173	0.43	9	0.007	24	0.930	173
1100	0.952	173	0.40	6	0.007	41	0.929	172
1150	0.947	172	0.37	4	0.007	35	0.932	171
1200	0.949	171	0.35	2	0.009	47	0.931	171
1250	0.951	171	0.32	0	0.009	52	0.934	170
1300	0.951	170	0.30	-1	0.009	42	0.931	169
1350	0.948	169	0.28	-2	0.011	51	0.931	168
1400	0.948	169	0.26	-4	0.011	53	0.935	167
1450	0.948	168	0.25	-5	0.011	55	0.927	167
1500	0.945	167	0.23	-6	0.012	64	0.927	165

COMMON SOURCE S-PARAMETER (PD54003S)

($V_{DS} = 7.5V$ $I_{DS} = 50mA$)

FREQ (MHz)	$ S_{11} $	$S_{11}\angle\Phi$	$ S_{21} $	$S_{21}\angle\Phi$	$ S_{12} $	$S_{12}\angle\Phi$	$ S_{22} $	$S_{22}\angle\Phi$
50	0.749	-133	9.42	93	0.063	4	0.702	-130
100	0.760	-151	4.51	74	0.060	-15	0.706	-147
150	0.799	-157	2.81	62	0.055	-26	0.747	-153
200	0.837	-160	1.93	52	0.051	-36	0.790	-157
250	0.869	-163	1.41	43	0.046	-43	0.835	-160
300	0.893	-165	1.08	37	0.041	-49	0.861	-162
350	0.913	-167	0.84	31	0.037	-53	0.885	-165
400	0.932	-169	0.68	26	0.033	-58	0.905	-167
450	0.941	-170	0.55	21	0.029	-61	0.918	-169
500	0.949	-172	0.46	18	0.026	-66	0.931	-170
550	0.961	-173	0.39	14	0.024	-68	0.943	-172
600	0.965	-174	0.33	11	0.021	-69	0.947	-173
650	0.969	-176	0.29	9	0.019	-74	0.954	-174
700	0.970	-177	0.25	6	0.017	-73	0.960	-175
750	0.974	-177	0.22	4	0.016	-73	0.962	-177
800	0.977	-178	0.20	2	0.014	-77	0.965	-177
850	0.979	-179	0.18	1	0.012	-79	0.965	-178
900	0.977	-180	0.16	-1	0.011	-82	0.968	-179
950	0.978	180	0.15	-3	0.010	-80	0.971	-180
1000	0.982	179	0.13	-4	0.009	-82	0.973	179
1050	0.983	178	0.12	-6	0.007	-88	0.974	178
1100	0.982	177	0.13	-7	0.005	-88	0.969	178
1150	0.982	177	0.10	-8	0.005	-83	0.975	177
1200	0.982	176	0.10	-9	0.004	-87	0.975	176
1250	0.984	176	0.09	-11	0.000	-90	0.972	176
1300	0.980	175	0.08	-11	0.020	-81	0.970	175
1350	0.978	175	0.08	-12	0.001	-111	0.974	175
1400	0.977	174	0.07	-12	0.001	-61	0.970	174
1450	0.979	174	0.07	-11	0.001	19	0.971	173
1500	0.976	173	0.06	-13	0.002	138	0.970	173

PD54003 - PD54003S**COMMON SOURCE S-PARAMETER (PD54003S)** $(V_{DS} = 7.5V \quad I_{DS} = 500mA)$

FREQ (MHz)	$ S_{11} $	$\angle S_{11}$	$ S_{21} $	$\angle S_{21}$	$ S_{12} $	$\angle S_{12}$	$ S_{22} $	$\angle S_{22}$
50	0.805	-165	13.88	88	0.025	1	0.806	-164
100	0.838	-170	6.74	81	0.003	-6	0.80372	-171
150	0.863	-172	4.43	76	0.024	-10	0.840	-173
200	0.873	-174	3.27	71	0.024	-15	0.814	-174
250	0.880	-175	2.57	65	0.023	-18	0.827	-175
300	0.884	-176	2.10	60	0.022	-22	0.83481	-175
350	0.891	-176	1.75	56	0.022	-27	0.845	-175
400	0.901	-177	1.49	51	0.020	-28	0.857	-176
450	0.906	-177	1.27	47	0.018	-33	0.863	-176
500	0.914	-178	1.10	43	0.017	-35	0.877	-177
550	0.923	-178	0.97	39	0.017	-37	0.881	-177
600	0.927	-179	0.85	36	0.015	-36	0.892	-177
650	0.931	-179	0.76	33	0.014	-39	0.902	-178
700	0.934	-180	0.68	30	0.013	-38	0.908	-78
750	0.941	180	0.62	27	0.012	-40	0.914	-179
800	0.944	179	0.56	25	0.012	-47	0.918	-180
850	0.948	179	0.51	22	0.010	-47	0.920	180
900	0.949	178	0.46	19	0.009	-42	0.927	179
950	0.951	178	0.43	17	0.008	-46	0.933	178
1000	0.954	177	0.40	15	0.006	-42	0.936	178
1050	0.955	177	0.37	13	0.007	-36	0.937	177
1100	0.959	176	0.34	10	0.006	-38	0.939	177
1150	0.960	176	0.32	9	0.004	-42	0.942	176
1200	0.961	175	0.30	7	0.004	-23	0.943	176
1250	0.965	175	0.28	5	0.004	0	0.942	175
1300	0.960	174	0.26	4	0.0036	2	0.941	175
1350	0.961	174	0.24	2	0.004	20	0.941	174
1400	0.959	173	0.23	1	0.004	30	0.941	173
1450	0.960	173	0.24	1	0.004	40	0.949	173
1500	0.959	172	0.20	0	0.003	50	0.948	172

COMMON SOURCE S-PARAMETER (PD54003S) $(V_{DS} = 7.5V \ I_{DS} = 1A)$

FREQ (MHz)	$ S_{11} $	$\angle S_{11}$	$ S_{21} $	$\angle S_{21}$	$ S_{12} $	$\angle S_{12}$	$ S_{22} $	$\angle S_{22}$
50	0.879	-164	14.04	88	0.021	0	0.828	-168
100	0.879	-172	6.82	82	0.020	-5	0.826	-174
150	0.885	-174	4.50	78	0.020	-9	0.832	-175
200	0.887	-175	3.34	73	0.020	-11	0.831	-176
250	0.890	-176	2.65	68	0.019	-16	0.844	-177
300	0.894	-177	2.18	64	0.019	-18	0.847	-176
350	0.898	-177	1.82	60	0.018	-21	0.857	-177
400	0.907	-178	1.57	55	0.017	-21	0.864	-177
450	0.910	-178	1.35	51	0.016	-25	0.866	-177
500	0.914	-179	1.18	47	0.015	-29	0.877	-178
550	0.922	-179	1.04	44	0.014	-30	0.887	-178
600	0.926	-180	0.93	41	0.014	-30	0.888	-179
650	0.930	180	0.84	38	0.130	-33	0.897	-179
700	0.934	179	0.75	35	0.012	-33	0.905	-180
750	0.938	179	0.68	32	0.011	-34	0.907	180
800	0.940	178	0.62	30	0.010	-33	0.914	179
850	0.946	178	0.57	27	0.010	-30	0.913	179
900	0.944	177	0.52	24	0.009	-27	0.921	178
950	0.946	177	0.48	22	0.008	-28	0.928	177
1000	0.95	176	0.45	19	0.008	-31	0.930	177
1050	0.949	176	0.42	17	0.006	-26	0.933	177
1100	0.953	176	0.39	15	0.006	-19	0.933	176
1150	0.954	175	0.36	13	0.005	-16	0.937	176
1200	0.956	175	0.34	11	0.005	-15	0.938	175
1250	0.957	174	0.32	9	0.004	3	0.934	175
1300	0.955	174	0.30	7	0.003	2	0.934	174
1350	0.955	173	0.28	6	0.005	25	0.937	174
1400	0.955	173	0.26	5	0.005	33	0.935	173
1450	0.957	172	0.25	4	0.005	31	0.943	172
1500	0.954	172	0.23	3	0.004	42	0.943	172

PowerSO-10RF Formed Lead (Gull Wing) MECHANICAL DATA

DIM.	mm			Inch		
	MIN.	TYP.	MAX	MIN.	TYP.	MAX
A1	0	0.05	0.1	0.	0.0019	0.0038
A2	3.4	3.5	3.6	0.134	0.137	0.142
A3	1.2	1.3	1.4	0.046	0.05	0.054
A4	0.15	0.2	0.25	0.005	0.007	0.009
a		0.2			0.007	
b	5.4	5.53	5.65	0.212	0.217	0.221
c	0.23	0.27	0.32	0.008	0.01	0.012
D	9.4	9.5	9.6	0.370	0.374	0.377
D1	7.4	7.5	7.6	0.290	0.295	0.298
E	13.85	14.1	14.35	0.544	0.555	0.565
E1	9.3	9.4	9.5	0.365	0.37	0.375
E2	7.3	7.4	7.5	0.286	0.292	0.294
E3	5.9	6.1	6.3	0.231	0.24	0.247
F		0.5			0.019	
G		1.2			0.047	
L	0.8	1	1.1	0.030	0.039	0.042
R1			0.25			0.01
R2		0.8			0.031	
T	2 deg	5 deg	8 deg	2 deg	5 deg	8 deg
T1		6 deg			6 deg	
T2		10 deg			10 deg	

Note (1): Resin protrusions not included (max value: 0.15 mm per side)

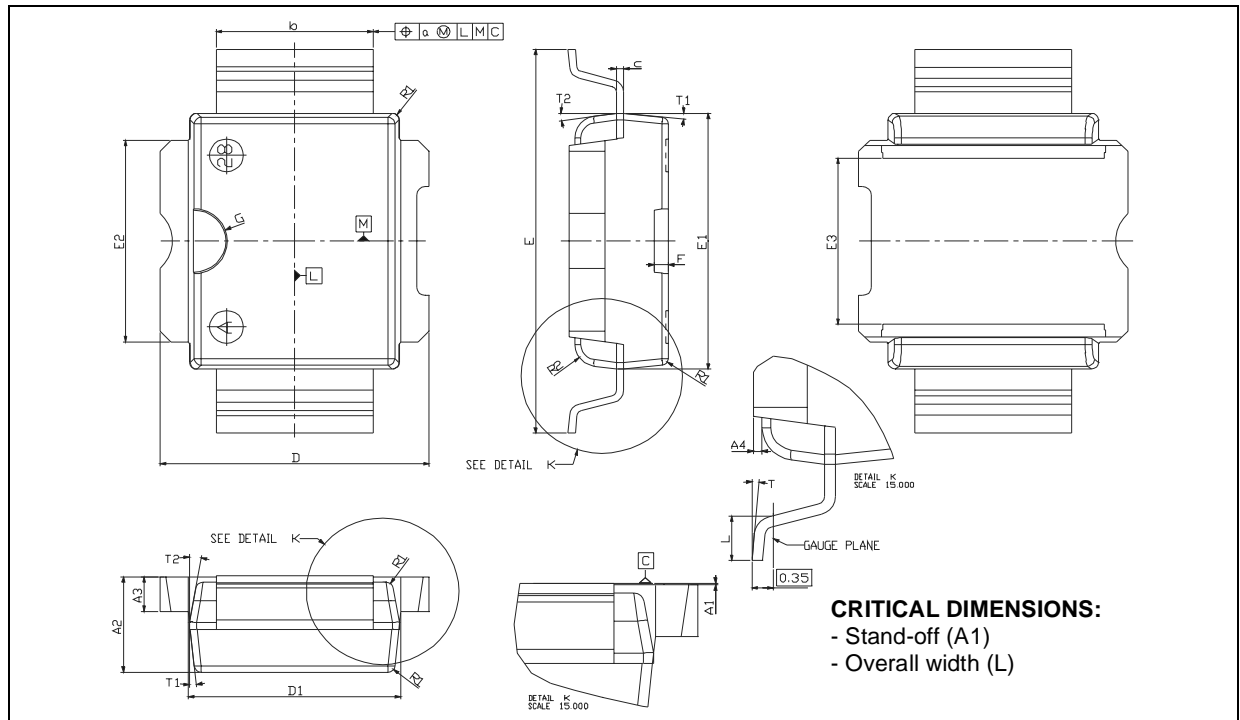

PowerSO-10RF Straight Lead MECHANICAL DATA

DIM.	mm			Inch		
	MIN.	TYP.	MAX	MIN.	TYP.	MAX
A1	1.62	1.67	1.72	0.064	0.065	0.068
A2	3.4	3.5	3.6	0.134	0.137	0.142
A3	1.2	1.3	1.4	0.046	0.05	0.054
A4	0.15	0.2	0.25	0.005	0.007	0.009
a		0.2			0.007	
b	5.4	5.53	5.65	0.212	0.217	0.221
c	0.23	0.27	0.32	0.008	0.01	0.012
D	9.4	9.5	9.6	0.370	0.374	0.377
D1	7.4	7.5	7.6	0.290	0.295	0.298
E	15.15	15.4	15.65	0.595	0.606	0.615
E1	9.3	9.4	9.5	0.365	0.37	0.375
E2	7.3	7.4	7.5	0.286	0.292	0.294
E3	5.9	6.1	6.3	0.231	0.24	0.247
F		0.5			0.019	
G		1.2			0.047	
R1			0.25			0.01
R2		0.8			0.031	
T1		6 deg			6 deg	
T2		10 deg			10 deg	

Note (1): Resin protrusions not included (max value: 0.15 mm per side)

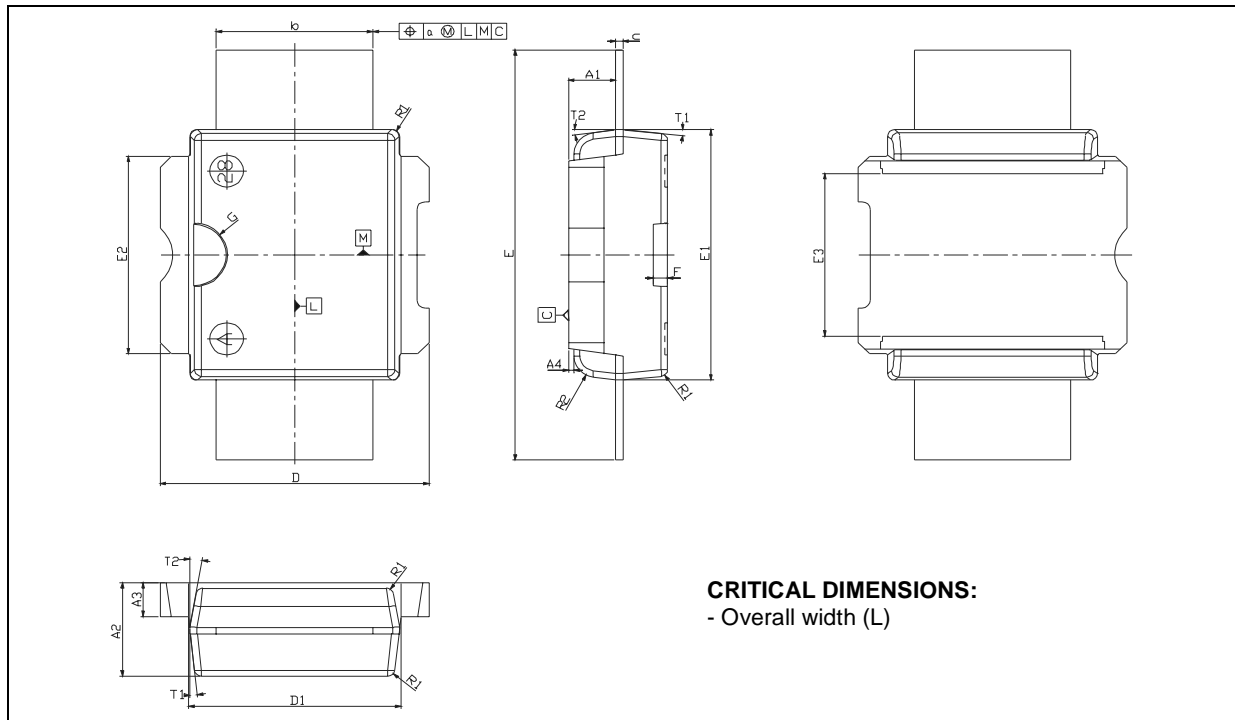

Information furnished is believed to be accurate and reliable. However, STMicroelectronics assumes no responsibility for the consequences of use of such information nor for any infringement of patents or other rights of third parties which may result from its use. No license is granted by implication or otherwise under any patent or patent rights of STMicroelectronics. Specifications mentioned in this publication are subject to change without notice. This publication supersedes and replaces all information previously supplied. STMicroelectronics products are not authorized for use as critical components in life support devices or systems without express written approval of STMicroelectronics.

The ST logo is registered trademark of STMicroelectronics
© 2001 STMicroelectronics - All Rights Reserved

All other names are the property of their respective owners.

STMicroelectronics GROUP OF COMPANIES
Australia - Brazil - China - Finland - France - Germany - Hong Kong - India - Italy - Japan - Malaysia - Malta - Morocco -
Singapore - Spain - Sweden - Switzerland - United Kingdom - U.S.A.

<http://www.st.com>