



SAW Components

BAW duplexer

1900 MHz CDMA (IS-95)

Series/type:	B7633
Ordering code:	B39192B7633D810
Date:	August 17, 2006
Version:	2.0



Application

- Low-loss RF duplexer for mobile telephone IS-95 CDMA systems



Features

- Package size 5.0 x 5.0 x 1.35 mm³
- Package code QCS12E
- RoHS compatible
- Approximate weight 0.08 g
- Package for **Surface Mount Technology (SMT)**
- Ni, gold-plated terminals
- Ni-UBM
- Matching network required at TX-port

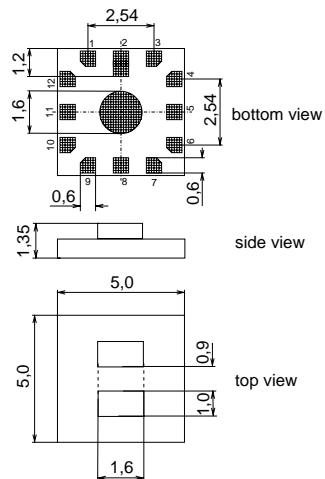

Pin configuration

- 11 TX input, single ended
- 5 RX output, single ended
- 8 Antenna

- 1, 2, 3, 4, 6 Ground
- 7, 9, 10, 12, 13 Ground

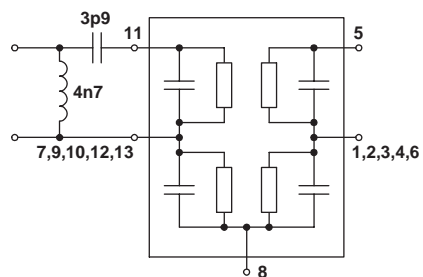



Data Sheet



Characteristics

Operating temperature range: T = -30 °C to +85 °C
 ANT terminating impedance: Z_{ANT} = 50 Ω
 RX terminating impedance: Z_{RX} = 50 Ω
 TX terminating impedance: Z_{TX} = 50 Ω

Characteristics TX-ANT

		min.	typ. @ 25°C	max.	
Center frequency	f _C	—	1880.0	—	MHz
Maximum insertion attenuation	α _{max}				
1850.6 ... 1853.0	MHz	—	2.1	3.3	dB
1853.0 ... 1907.0	MHz	—	2.6	3.0	dB
1907.0 ... 1909.4	MHz	—	2.7	3.5	dB
Amplitude ripple (p-p)	Δα				
1850.6 ... 1909.4	MHz	—	1.4	2.2	dB
Return loss					
TX port	1850.6 ... 1909.4	8.0	10.0	—	dB
ANT port	1850.6 ... 1989.4	6.0	8.0	—	dB
Attenuation	α				
0.3 ... 1570.0	MHz	31	33.5	—	dB
1570.0 ... 1580.0	MHz	30	32.5	—	dB
1580.0 ... 1800.0	MHz	29	31.5	—	dB
1930.6 ... 1935.0	MHz	42	51.5	—	dB
1935.0 ... 1989.4	MHz	38	41.5	—	dB
2400.0 ... 2500.0	MHz	34	36.5	—	dB
2500.0 ... 3400.0	MHz	20	28	—	dB
3400.0 ... 4400.0	MHz	25	30	—	dB
4400.0 ... 5550.0	MHz	5	7.5	—	dB
5550.0 ... 5730.0	MHz	5	7.5	—	dB



Data Sheet



Characteristics

Operating temperature range: T = -30 °C to +85 °C
 ANT terminating impedance: Z_{ANT} = 50 Ω
 RX terminating impedance: Z_{RX} = 50 Ω
 TX terminating impedance: Z_{TX} = 50 Ω

Characteristics ANT-RX

		min.	typ. @ 25°C	max.	
Center frequency	f _C	—	1960.0	—	MHz
Maximum insertion attenuation	α _{max}				
1930.6 ... 1935.0	MHz	—	3.6	4.5 ¹⁾	dB
1935.0 ... 1987.0	MHz	—	3.1	3.5	dB
1987.0 ... 1989.4	MHz	—	2.1	3.5	dB
Amplitude ripple (p-p)	Δα				
1930.6 ... 1989.4	MHz	—	1.4	2.7	dB
Return loss					
RX port	1930.6 ... 1989.4	4.0	5.5	—	dB
ANT port	1850.6 ... 1989.4	6.0	8.0	—	dB
Attenuation	α				
0.3 ... 1770.0	MHz	33	35.5	—	dB
1770.0 ... 1850.6	MHz	39	41.5	—	dB
1850.6 ... 1905.0	MHz	54	57	—	dB
1905.0 ... 1909.4	MHz	48	58	—	dB
2010.0 ... 2070.0	MHz	7	20	—	dB
2070.0 ... 2750.0	MHz	39	41.5	—	dB
2750.0 ... 3350.0	MHz	20	34	—	dB
3350.0 ... 3500.0	MHz	39	41.5	—	dB
3500.0 ... 4500.0	MHz	30	40	—	dB
4500.0 ... 6000.0	MHz	20	25	—	dB

1) 4.0dB for 25°C to 85°C



SAW Components

B7633

BAW duplexer

1880.00 / 1960.00 MHz

Data Sheet



Characteristics TX-RX				min.	typ. @ 25°C	max.	
Isolation between RX and TX							
	0.3	...	1800.0 MHz	57	62	—	dB
	1850.6	...	1907.0 MHz	54	58	—	dB
	1907.0	...	1909.4 MHz	50	57	—	dB
	1930.6	...	1935.0 MHz	44	54	—	dB
	1935.0	...	1989.4 MHz	42	44	—	dB
	2070.0	...	4200.0 MHz	53	60	—	dB



SAW Components

B7633

BAW duplexer

1880.00 / 1960.00 MHz

Data Sheet



Maximum ratings

Operable temperature range	T	-30 / +85	°C	
Storage temperature range	T _{stg}	-40 / +85	°C	
DC voltage	V _{DC}	3	V	
ESD voltage	V _{ESD}	100 ¹⁾	V	source and load impedance 50 Ω
Input Power at				
1850.6 ... 1909.4 MHz	P _{IN}	29	dBm	CDMA modulated signal
elsewhere	P _{IN}	10	dBm	CW

1) acc. to JESD22-A115A (machine model), 1 negative & 1 positive pulse.



Frequency Response TX - ANT

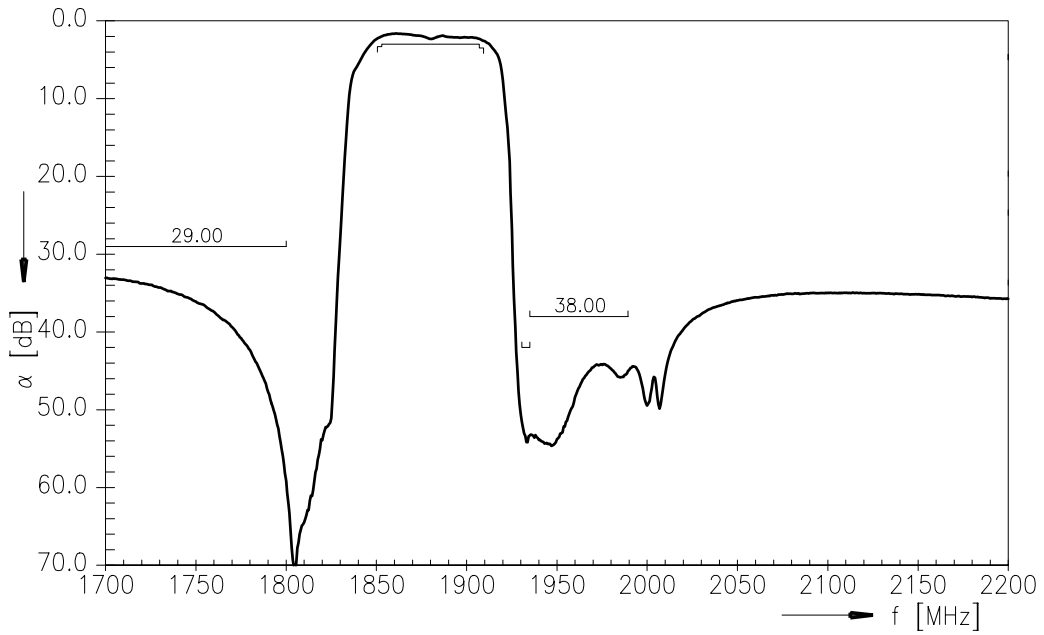

Frequency Response TX - ANT (wideband)

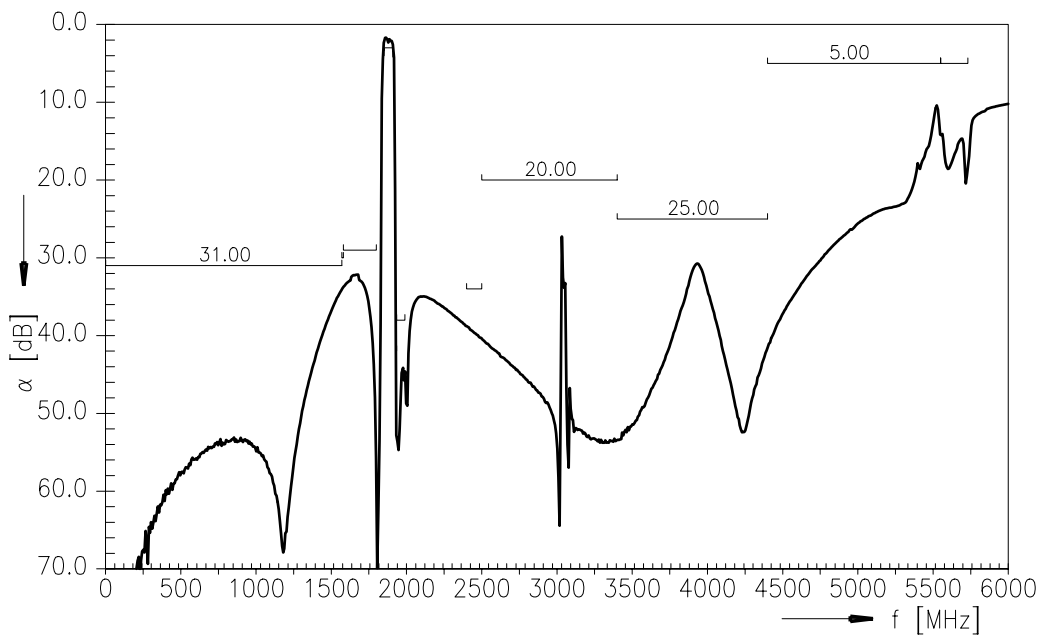



Frequency Response ANT - RX

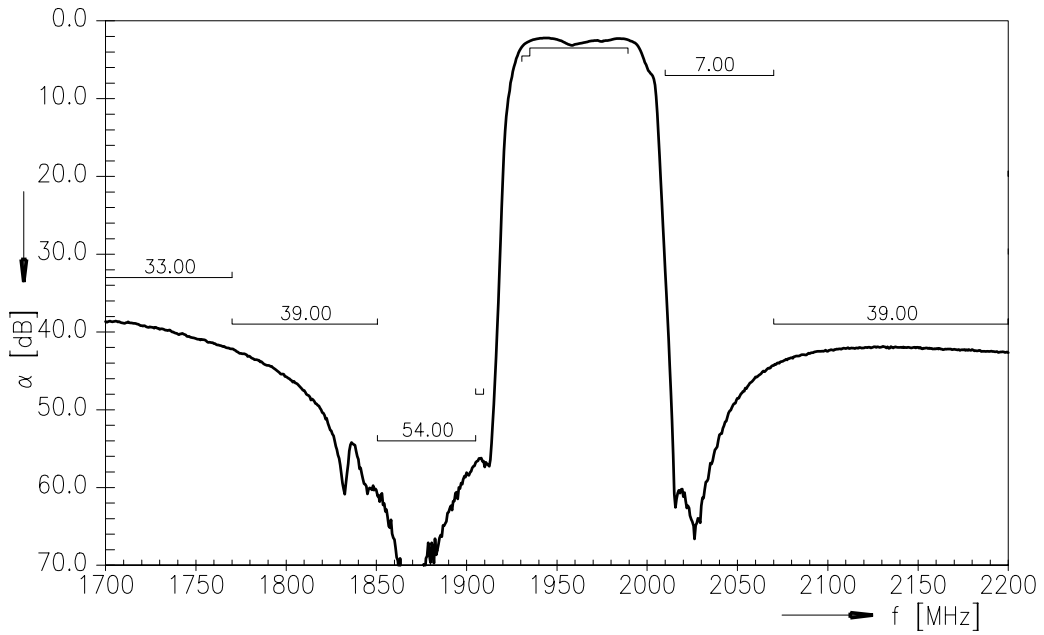

Frequency Response ANT - RX (wideband)

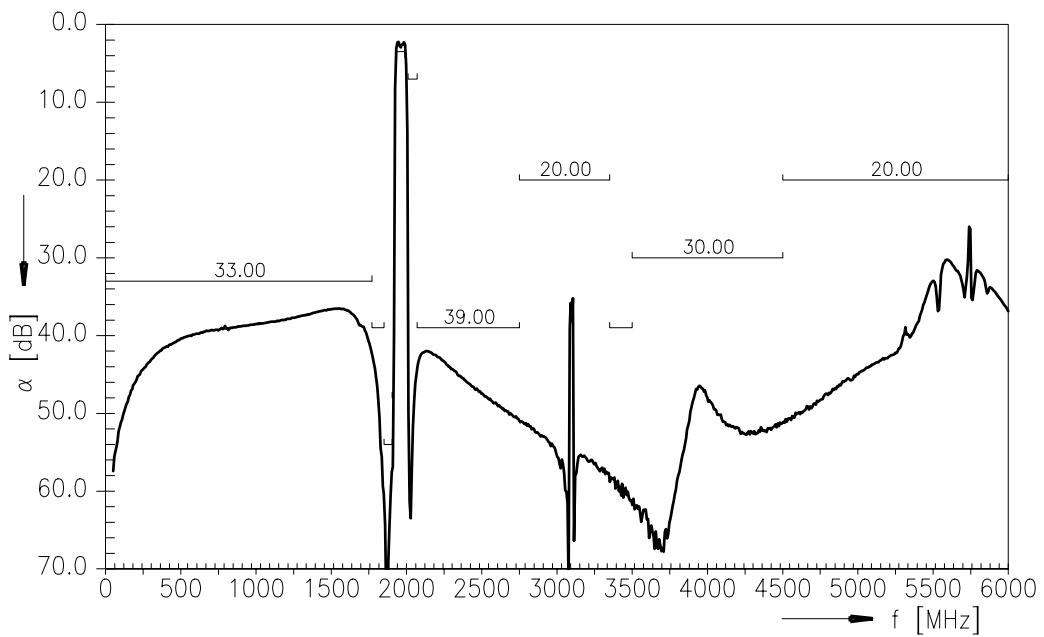



Frequency Response TX - RX

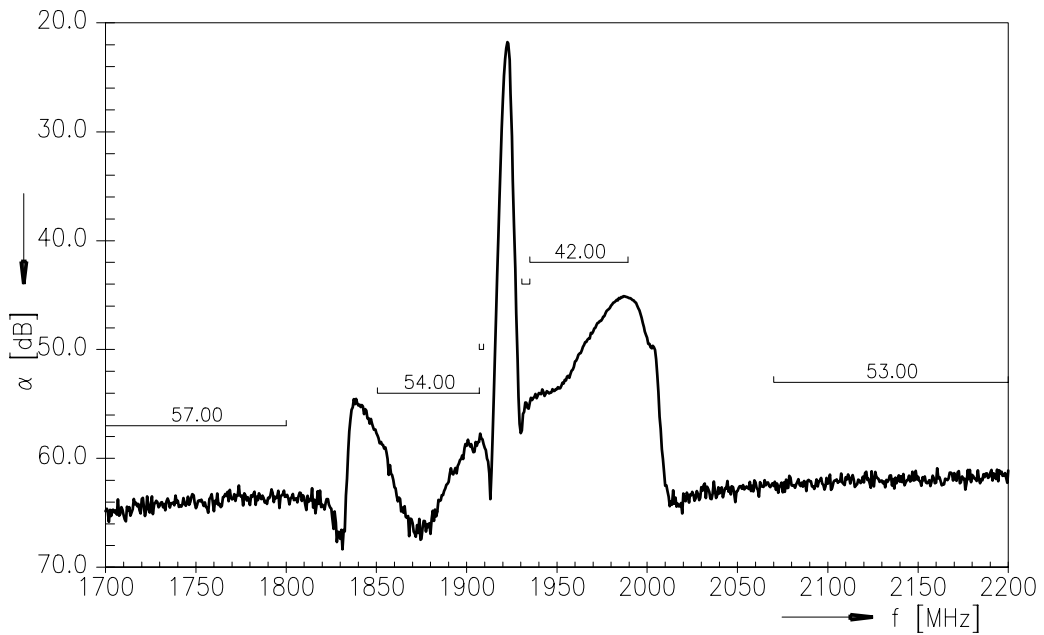

Frequency Response TX - RX (wideband)

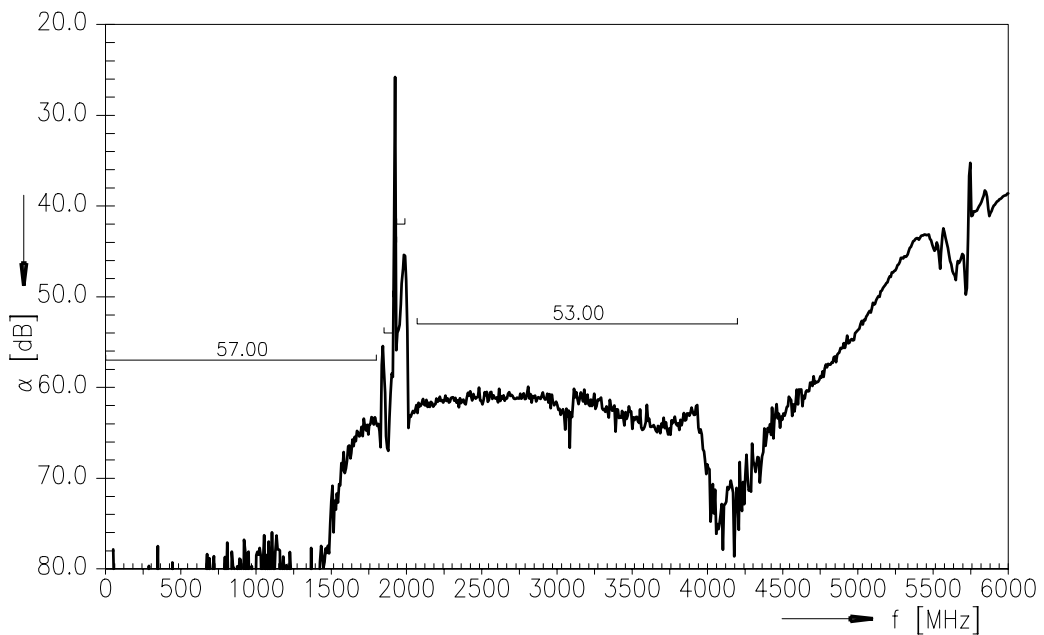



SAW Components

B7633

BAW duplexer

1880.00 / 1960.00 MHz

Data Sheet



Return Loss: S_{11} TX-port

S_{22} ANT-port

S_{33} RX-port

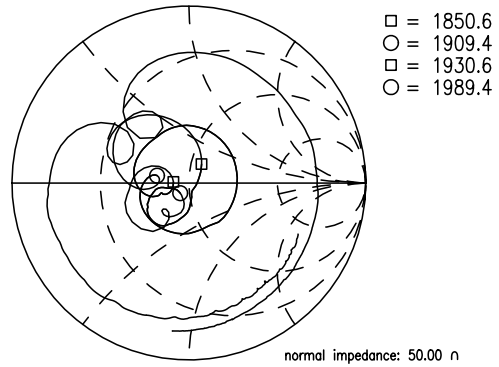
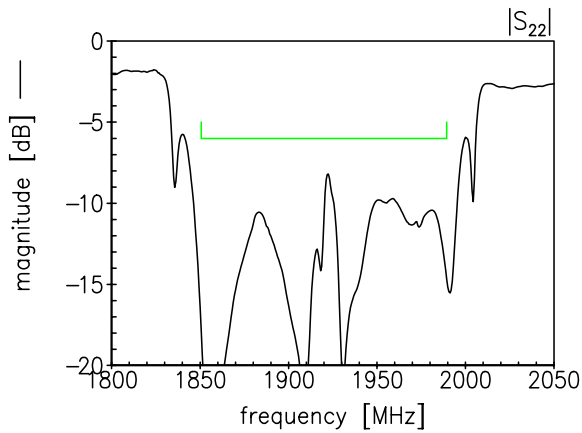
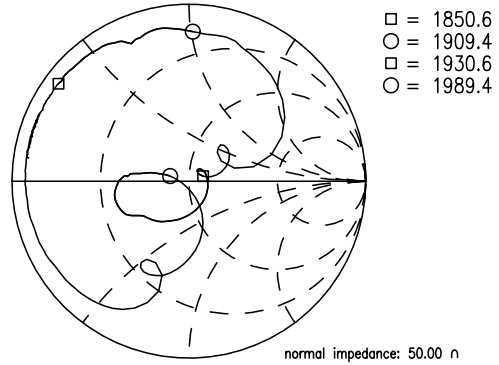
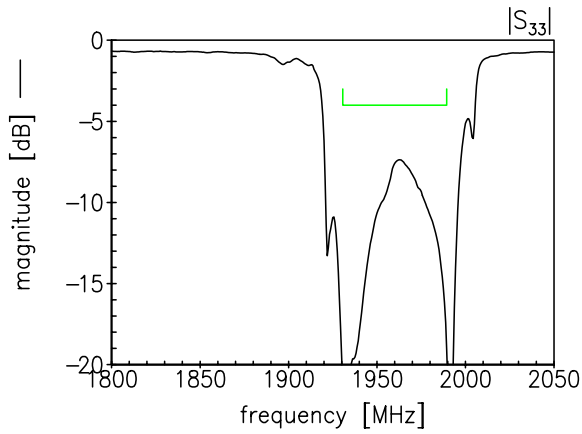
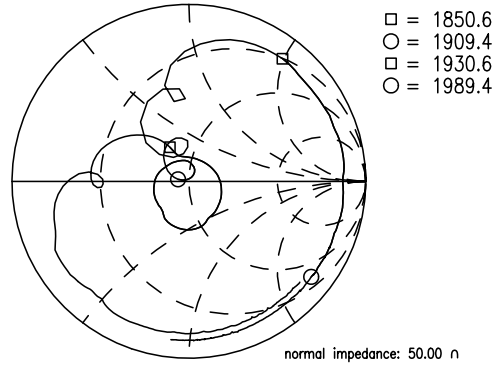
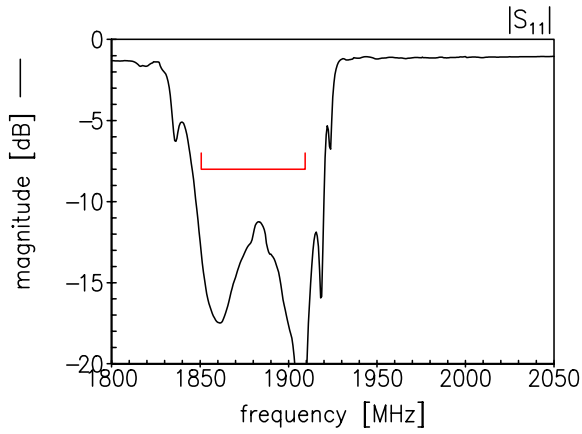

Please read *cautions and warnings* and *important notes* at the end of this document.



SAW Components

B7633

BAW duplexer

1880.00 / 1960.00 MHz

Data Sheet



References

Type	B7633
Ordering code	B39192-B7633-D810
Marking and Package	C61157-A3-A5
Packaging	F61074-V8159-Z000
Date Codes	L_1126
S-Parameters	B7633_NB.s3p B7633_WB.s3p
Soldering profile	S_6001
RoHS compatible	defined as compatible with the following documents: "DIRECTIVE 2002/95/EC OF THE EUROPEAN PARLIAMENT AND OF THE COUNCIL of 27 January 2003 on the restriction of the use of certain hazardous substances in electrical and electronic equipment. 2005/618/EC from April 18th, 2005, amending Directive 2002/95/EC of the European Parliament and of the Council for the purposes of establishing the maximum concentration values for certain hazardous substances in electrical and electronic equipment."

For further information please contact your local EPCOS sales office or visit our webpage at www.epcos.com.

Published by EPCOS AG
Surface Acoustic Wave Components Division
P.O. Box 80 17 09, 81617 Munich, GERMANY

© EPCOS AG 2006. This brochure replaces the previous edition.

For questions on technology, prices and delivery please contact the Sales Offices of EPCOS AG or the international Representatives.

Due to technical requirements components may contain dangerous substances. For information on the type in question please also contact one of our Sales Offices.

Please read *cautions and warnings and important notes* at the end of this document.



Important notes

The following applies to all products named in this publication:

1. Some parts of this publication contain **statements about the suitability of our products for certain areas of application**. These statements are based on our knowledge of typical requirements that are often placed on our products in the areas of application concerned. We nevertheless expressly point out **that such statements cannot be regarded as binding statements about the suitability of our products for a particular customer application**. As a rule, EPCOS is either unfamiliar with individual customer applications or less familiar with them than the customers themselves. For these reasons, it is always ultimately incumbent on the customer to check and decide whether an EPCOS product with the properties described in the product specification is suitable for use in a particular customer application.
2. We also point out that **in individual cases, a malfunction of passive electronic components or failure before the end of their usual service life cannot be completely ruled out in the current state of the art, even if they are operated as specified**. In customer applications requiring a very high level of operational safety and especially in customer applications in which the malfunction or failure of a passive electronic component could endanger human life or health (e.g. in accident prevention or life-saving systems), it must therefore be ensured by means of suitable design of the customer application or other action taken by the customer (e.g. installation of protective circuitry or redundancy) that no injury or damage is sustained by third parties in the event of malfunction or failure of a passive electronic component.
3. The warnings, cautions and product-specific notes must be observed.
4. In order to satisfy certain technical requirements, **some of the products described in this publication may contain substances subject to restrictions in certain jurisdictions (e.g. because they are classed as "hazardous")**. Useful information on this will be found in our Material Data Sheets on the Internet (www.epcos.com/material). Should you have any more detailed questions, please contact our sales offices.
5. We constantly strive to improve our products. Consequently, **the products described in this publication may change from time to time**. The same is true of the corresponding product specifications. Please check therefore to what extent product descriptions and specifications contained in this publication are still applicable before or when you place an order. We also **reserve the right to discontinue production and delivery of products**. Consequently, we cannot guarantee that all products named in this publication will always be available.
6. Unless otherwise agreed in individual contracts, **all orders are subject to the current version of the "General Terms of Delivery for Products and Services in the Electrical Industry" published by the German Electrical and Electronics Industry Association (ZVEI)**.
7. The trade names EPCOS, CeraDiode, CSSP, PhaseCap, PhaseMod, SIFI, SIKOREL, Silver-Cap, SIMID, SIOV, SIP5D, SIP5K, TOPcap, UltraCap, WindCap are **trademarks registered or pending** in Europe and in other countries. Further information will be found on the Internet at www.epcos.com/trademarks.