



# Video Encoders with Six 10-Bit DACs and 54 MHz Oversampling

## ADV7190/ADV7191\*

### FEATURES

- Six High Quality 10-Bit Video DACs
- Multistandard Video Input
- Multistandard Video Output
- 4× Oversampling with Internal 54 MHz PLL
- Programmable Video Control Includes:
  - Digital Noise Reduction
  - Gamma Correction
  - LUMA Delay
  - CHROMA Delay
- Multiple Luma and Chroma Filters
- Luma SSAF™ (Super Subalias Filter)
- Average Brightness Detection
- Field Counter
- Macrovision Rev 7.1 (ADV7190 Only)
- CGMS (Copy Generation Management System)
- WSS (Wide Screen Signaling)
- Closed Captioning Support
- Teletext Insertion Port (PAL-WST)
- 2-Wire Serial MPU Interface
- Supply Voltage 5 V and 3.3 V Operation
- 64-Lead LQFP Package

### APPLICATIONS

- DVD Playback Systems,
- PC Video/Multimedia Playback Systems

### GENERAL DESCRIPTION

The ADV7190/ADV7191 is part of the new generation of video encoders from Analog Devices. The device builds on the performance of previous video encoders and provides new features such as Digital Noise Reduction, Gamma Correction, 4× Oversampling and 54 MHz operation, Average Brightness Detection, Chroma Delay, an additional Chroma Filter, and so on.

The ADV7190/ADV7191 supports NTSC-M, NTSC-N (Japan), PAL N, PAL M, PAL-B/D/G/H/I, and PAL-60 standards. Input standards supported include ITU-R.BT656/601 4:2:2 YCrCb in 8- or 16-bit format.

The ADV7190/ADV7191 can output Composite Video (CVBS), S-Video (Y/C), Component YUV<sup>1</sup>, or RGB. The analog component output is also compatible with Betacam, MII and SMPTE/EBU N10 levels, SMPTE 170M NTSC, and ITU-R.BT 470 PAL.

For more information about the ADV7190/ADV7191's features, refer to Detailed Description.

*Continued on page 11*

### SIMPLIFIED FUNCTIONAL BLOCK DIAGRAM

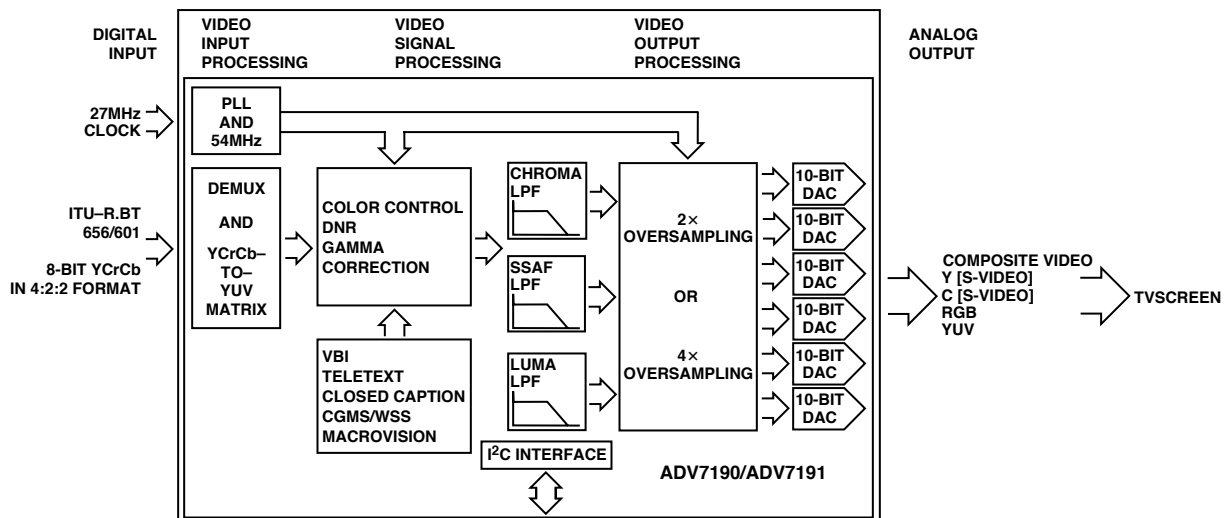

\*This device is protected by U.S. Patent Numbers 4631603, 4577216, and 4819098, and other intellectual property rights.

<sup>1</sup>Throughout the document, YUV refers to digital or analog component video.

The Macrovision anticopy process is licensed for noncommercial home use only, which is its sole intended use in the device. Please contact sales office for latest available Macrovision version. ITU-R and CCIR are used interchangeably in this document (ITU-R has replaced CCIR recommendations).

SSAF is a trademark of Analog Devices Inc.

I<sup>2</sup>C is a registered trademark of Philips Corporation.

### REV. B

Information furnished by Analog Devices is believed to be accurate and reliable. However, no responsibility is assumed by Analog Devices for its use, nor for any infringements of patents or other rights of third parties that may result from its use. No license is granted by implication or otherwise under any patent or patent rights of Analog Devices.

# ADV7190/ADV7191

## CONTENTS

FEATURES .....	1
APPLICATIONS .....	1
GENERAL DESCRIPTION .....	1
SPECIFICATIONS	
5 V .....	3
3.3 V .....	4
5 V DYNAMIC .....	5
3.3 V DYNAMIC .....	5
5 V TIMING CHARACTERISTICS .....	6
3.3 V TIMING CHARACTERISTICS .....	7
ABSOLUTE MAXIMUM RATINGS .....	9
PACKAGE THERMAL PERFORMANCE .....	9
PIN CONFIGURATION .....	9
ORDERING GUIDE .....	9
PIN FUNCTION DESCRIPTIONS .....	10
DETAILED DESCRIPTION OF FEATURES .....	11
GENERAL DESCRIPTION .....	11
DATA PATH DESCRIPTION .....	12
INTERNAL FILTER RESPONSE.. .....	13
FEATURES: FUNCTIONAL DESCRIPTION .....	17
Brightness Detect .....	17
Chroma/Luma Delay .....	17
Clamp Output .....	17
$\overline{\text{CSO}}$ , $\overline{\text{HSO}}$ , and $\overline{\text{VSO}}$ Outputs .....	17
Color Bar Generation .....	17
Color Burst Signal Control .....	17
Color Controls .....	17
Chrominance Control .....	17
Undershoot Limiter .....	17
Digital Noise Reduction .....	17
Double Buffering .....	18
Gamma Correction Control .....	18
NTSC Pedestal Control .....	18
Power-On $\overline{\text{RESET}}$ .....	18
Real-Time Control, Subcarrier Reset, and Timing Reset .....	18
SCH Phase Mode .....	18
Sleep Mode .....	18
Square Pixel Mode .....	19
Vertical Blanking Data Insertion And $\overline{\text{BLANK}}$ Input .....	19
YUV Levels .....	19
16-Bit Interface .....	19
4× Oversampling and Internal PLL .....	19
VIDEO TIMING DESCRIPTION .....	19
$\overline{\text{RESET}}$ SEQUENCE .....	20
MPU PORT DESCRIPTION .....	27
REGISTER ACCESSES .....	28
REGISTER PROGRAMMING .....	28
MODE REGISTERS .....	29
TIMING REGISTERS .....	35
SUBCARRIER FREQUENCY AND PHASE REGISTERS .....	36
CLOSED CAPTIONING REGISTERS .....	36
NTSC PEDESTAL REGISTERS .....	37
TELETEXT REQUEST CONTROL REGISTER .....	37
CGMS_WSS REGISTERS .....	37
CONTRAST CONTROL REGISTER .....	38
COLOR CONTROL REGISTERS .....	38
HUE ADJUST CONTROL REGISTER .....	39
BRIGHTNESS CONTROL REGISTERS .....	39
SHARPNESS CONTROL REGISTER .....	40
DNR REGISTERS .....	40
GAMMA CORRECTION REGISTERS .....	42
BRIGHTNESS DETECT REGISTER .....	43
OUTPUT CLOCK REGISTER .....	43
APPENDIX 1	
BOARD DESIGN AND LAYOUT CONSIDERATIONS .....	44
APPENDIX 2	
CLOSED CAPTIONING .....	46
APPENDIX 3	
COPY GENERATION MANAGEMENT SYSTEM (CGMS) .....	47
APPENDIX 4	
WISE SCREEN SIGNALING (WSS) .....	48
APPENDIX 5	
TELETEXT INSERTION .....	49
APPENDIX 6	
OPTIONAL OUTPUT FILTER .....	50
APPENDIX 7	
DAC BUFFERING .....	51
APPENDIX 8	
RECOMMENDED REGISTER VALUES .....	52
APPENDIX 9	
NTSC WAVEFORMS (WITH PEDESTAL) .....	56
NTSC WAVEFORMS (WITHOUT PEDESTAL) .....	57
PAL WAVEFORMS .....	58
UV WAVEFORMS .....	59
OUTPUT WAVEFORMS .....	60
VIDEO MEASUREMENT PLOTS .....	64
APPENDIX 10	
VECTOR PLOTS .....	68
OUTLINE DIMENSIONS .....	69
Revision History .....	70

## SPECIFICATIONS

5 V SPECIFICATIONS<sup>1</sup> ( $V_{AA} = 5\text{ V}$ ,  $V_{REF} = 1.235\text{ V}$ ,  $R_{SET1,2} = 1200\ \Omega$ , unless otherwise noted. All specifications  $T_{MIN}$  to  $T_{MAX}$ <sup>2</sup>, unless otherwise noted.)

Parameter	Min	Typ	Max	Unit	Test Conditions	
<b>STATIC PERFORMANCE</b>						
Resolution (Each DAC)			10	Bits	Guaranteed Monotonic	
Accuracy (Each DAC)						
Integral Nonlinearity <sup>3</sup>			$\pm 1.0$	LSB		
Differential Nonlinearity <sup>3</sup>			$\pm 1.0$	LSB		
<b>DIGITAL INPUTS</b>						
Input High Voltage, $V_{INH}$	2			V	$V_{IN} = 0.4\text{ V}$ or $2.4\text{ V}$	
Input Low Voltage, $V_{INL}$			0.8	V		
Input Current, $I_{IN}$		0	$\pm 1$	$\mu\text{A}$		
Input Capacitance, $C_{IN}$		6	10	pF		
Input Leakage Current		1		$\mu\text{A}$		
<b>DIGITAL OUTPUTS</b>						
Output High Voltage, $V_{OH}$	2.4			V	$I_{SOURCE} = 400\ \mu\text{A}$ $I_{SINK} = 3.2\text{ mA}$	
Output Low Voltage, $V_{OL}$		0.8	0.4	V		
Three-State Leakage Current		10		$\mu\text{A}$		
Three-State Output Capacitance		6	10	pF		
<b>ANALOG OUTPUTS</b>						
Output Current (Max)	4.125	4.33	4.625	mA	$R_L = 300\ \Omega$ , $R_{SET1,2} = 1200\ \Omega$ $R_L = 600\ \Omega$ , $R_{SET1,2} = 2400\ \Omega$	
Output Current (Min)		2.16		mA		
DAC-to-DAC Matching <sup>3</sup>		0.4	2.5	%		
Output Compliance, $V_{OC}$	0		1.4	V		
Output Impedance, $R_{OUT}$		100		k $\Omega$		
Output Capacitance, $C_{OUT}$		6		pF	$I_{OUT} = 0\text{ mA}$	
<b>VOLTAGE REFERENCE<sup>4</sup></b>						
Reference Range, $V_{REF}$	1.112	1.235	1.359	V		
<b>POWER REQUIREMENTS</b>						
$V_{AA}$	4.75	5.0	5.25	V		
Normal Power Mode						
$I_{DAC}$ <sup>5</sup>		29	35	mA		
$I_{CCT}$ (2 $\times$ Oversampling) <sup>6, 7</sup>		80	120	mA		
$I_{CCT}$ (4 $\times$ Oversampling) <sup>6, 7</sup>		120	170	mA		
$I_{PLL}$		6	10	mA		
Sleep Mode						
$I_{DAC}$		0.01		$\mu\text{A}$		
$I_{CCT}$		85		$\mu\text{A}$		

## NOTES

<sup>1</sup>All measurements are made in 4 $\times$  Oversampling Mode unless otherwise specified.<sup>2</sup>Temperature range  $T_{MIN}$  to  $T_{MAX}$ : 0°C to 70°C.<sup>3</sup>Guaranteed by characterization.<sup>4</sup>Measurement made in 2 $\times$  oversampling mode.<sup>5</sup> $I_{DAC}$  is the total current required to supply all DACs including the  $V_{REF}$  circuitry.<sup>6</sup>All six DACs ON.<sup>7</sup> $I_{CCT}$ , or the circuit current, is the continuous current required to drive the digital core without  $I_{PLL}$ .

Specifications subject to change without notice.

# ADV7190/ADV7191—SPECIFICATIONS

## 3.3 V SPECIFICATIONS<sup>1</sup> ( $V_{AA} = 3.3\text{ V}$ , $V_{REF} = 1.235\text{ V}$ , $R_{SET1,2} = 1200\ \Omega$ , unless otherwise noted. All specifications $T_{MIN}$ to $T_{MAX}$ <sup>2</sup>, unless otherwise noted.)

Parameter	Min	Typ	Max	Unit	Test Conditions	
<b>STATIC PERFORMANCE</b>						
Resolution (Each DAC)			10	Bits	Guaranteed Monotonic	
Accuracy (Each DAC)						
Integral Nonlinearity			$\pm 1.0$	LSB		
Differential Nonlinearity			$\pm 1.0$	LSB		
<b>DIGITAL INPUTS</b>						
Input High Voltage, $V_{INH}$		2		V	$V_{IN} = 0.4\text{ V or }2.4\text{ V}$	
Input Low Voltage, $V_{INL}$		0.8		V		
Input Current, $I_{IN}$			$\pm 1$	$\mu\text{A}$		
Input Capacitance, $C_{IN}$		6	10	pF		
Input Leakage Current		1		$\mu\text{A}$		
<b>DIGITAL OUTPUTS</b>						
Output High Voltage, $V_{OH}$		2.4		V	$I_{SOURCE} = 400\ \mu\text{A}$ $I_{SINK} = 3.2\text{ mA}$	
Output Low Voltage, $V_{OL}$		0.4		V		
Three-State Leakage Current		10		$\mu\text{A}$		
Three-State Output Capacitance		6	10	pF		
<b>ANALOG OUTPUTS</b>						
Output Current (Max)	4.25	4.33	4.625	mA	$R_{SET1,2} = 1200\ \Omega$ , $R_L = 300\ \Omega$ $R_L = 600\ \Omega$ , $R_{SET1,2} = 2400\ \Omega$	
Output Current (Min)		2.16		mA		
DAC-to-DAC Matching		0.4		%	$I_{OUT} = 0\text{ mA}$	
Output Compliance, $V_{OC}$			1.4	V		
Output Impedance, $R_{OUT}$		100		k $\Omega$		
Output Capacitance, $C_{OUT}$		6	30	pF		
<b>VOLTAGE REFERENCE<sup>3</sup></b>						
Reference Range, $V_{REF}$		1.235		V	$I_{VREFOUT} = 20\ \mu\text{A}$	
<b>POWER REQUIREMENTS</b>						
$V_{AA}$	3.15	3.3	3.45	V		
Normal Power Mode						
$I_{DAC}$ <sup>4</sup>		29		mA		
$I_{CCT}$ (2 $\times$ Oversampling) <sup>5, 6</sup>		42	54	mA		
$I_{CCT}$ (4 $\times$ Oversampling) <sup>5, 6</sup>		68	86	mA		
$I_{PLL}$		6		mA		
Sleep Mode						
$I_{DAC}$		0.01		$\mu\text{A}$		
$I_{CCT}$		85		$\mu\text{A}$		

### NOTES

<sup>1</sup>All measurements are made in 4 $\times$  Oversampling Mode unless otherwise specified and are guaranteed by characterization. In 2 $\times$  Oversampling Mode, the power requirement for the ADV7190/ADV7191 are typically 3.0 V.

<sup>2</sup>Temperature range  $T_{MIN}$  to  $T_{MAX}$ : 0°C to 70°C.

<sup>3</sup>Measurement made in 2 $\times$  oversampling mode.

<sup>4</sup> $I_{DAC}$  is the total current required to supply all DACs including the  $V_{REF}$  circuitry.

<sup>5</sup>All six DACs ON.

<sup>6</sup> $I_{CCT}$ , or the circuit current, is the continuous current required to drive the digital core without  $I_{PLL}$ .

Specifications subject to change without notice.

**5 V DYNAMIC—SPECIFICATIONS<sup>1</sup>** ( $V_{AA} = 5\text{ V} \pm 250\text{ mV}$ ,  $V_{REF} = 1.235\text{ V}$ ,  $R_{SET1,2} = 1200\ \Omega$ , unless otherwise noted. All specifications  $T_{MIN}$  to  $T_{MAX}$ <sup>2</sup>, unless otherwise noted.)

Parameter	Min	Typ	Max	Unit	Test Conditions
Differential Gain <sup>3</sup>		0.1 (0.4)	0.3 (0.5)	%	RMS Peak Periodic
Differential Phase <sup>3</sup>		0.4 (0.15)	0.5 (0.3)	Degrees	
SNR (Pedestal) <sup>3</sup>		78.5 (78)		dB rms	
				dB p-p	RMS
SNR (Ramp) <sup>3</sup>	61.7 (61.7)			dB rms	Peak Periodic
	62 (63)			dB p-p	RMS
Hue Accuracy		0.5		Degrees	Peak Periodic
Color Saturation Accuracy		0.7		%	
Chroma Nonlinear Gain		0.7	0.9	±%	Referenced to 40 IRE
Chroma Nonlinear Phase		0.5		±Degrees	
Chroma/Luma Intermod		0.1		±%	
Chroma/Luma Gain Ineq		1.7		±%	
Chroma/Luma Delay Ineq		2.2		ns	
Luminance Nonlinearity		0.6	0.7	±%	
Chroma AM Noise		82		dB	
Chroma PM Noise		72		dB	

NOTES

<sup>1</sup>All measurements are made in 4× Oversampling Mode unless otherwise specified.

<sup>2</sup>Temperature range  $T_{MIN}$  to  $T_{MAX}$ : 0°C to 70°C.

<sup>3</sup>Values in parentheses apply to 2× Oversampling Mode.

Specifications subject to change without notice.

**3.3 V DYNAMIC—SPECIFICATIONS<sup>1</sup>** ( $V_{AA} = 3.3\text{ V} \pm 150\text{ mV}$ ,  $V_{REF} = 1.235\text{ V}$ ,  $R_{SET1,2} = 1200\ \Omega$ , unless otherwise noted. All specifications  $T_{MIN}$  to  $T_{MAX}$ <sup>2</sup>, unless otherwise noted.)

Parameter	Min	Typ	Max	Unit	Test Conditions
Differential Gain <sup>3</sup>		0.2 (0.5)		%	RMS Peak Periodic
Differential Phase <sup>3</sup>		0.5 (0.2)		Degrees	
SNR (Pedestal) <sup>3</sup>		78.5 (78)		dB rms	
				dB p-p	RMS
SNR (Ramp) <sup>3</sup>	62.3 (62)			dB rms	Peak Periodic
	61 (62.5)			dB p-p	RMS
Hue Accuracy		0.5		Degrees	Peak Periodic
Color Saturation Accuracy		0.8		%	
Chroma Nonlinear Gain		0.6		±%	Referenced to 40 IRE
Chroma Nonlinear Phase		0.5		±Degrees	
Chroma/Luma Intermod		0.1		±%	
Luminance Nonlinearity		0.6		±%	
Chroma AM Noise		83		dB	
Chroma PM Noise		71		dB	

NOTES

<sup>1</sup>All measurements are made in 4× Oversampling Mode unless otherwise specified.

<sup>2</sup>Temperature range  $T_{MIN}$  to  $T_{MAX}$ : 0°C to 70°C.

<sup>3</sup>Values in parentheses apply to 2× Oversample Mode.

Specifications subject to change without notice.

# ADV7190/ADV7191

## 5 V TIMING CHARACTERISTICS ( $V_{AA} = 5\text{ V} \pm 250\text{ mV}$ , $V_{REF} = 1.235\text{ V}$ , $R_{SET1,2} = 1200\ \Omega$ , unless otherwise noted. All specifications $T_{MIN}$ to $T_{MAX}$ <sup>1</sup>, unless otherwise noted.)

Parameter	Min	Typ	Max	Unit	Test Conditions
<b>MPU PORT<sup>2</sup></b>					
SCLOCK Frequency	0		400	kHz	After This Period, the First Clock is Generated Relevant for Repeated Start Condition
SCLOCK High Pulsewidth, $t_1$	0.6			$\mu\text{s}$	
SCLOCK Low Pulsewidth, $t_2$	1.3			$\mu\text{s}$	
Hold Time (Start Condition), $t_3$	0.6			$\mu\text{s}$	
Setup Time (Start Condition), $t_4$	0.6			$\mu\text{s}$	
Data Setup Time, $t_5$	100			ns	
SDATA, SCLOCK Rise Time, $t_6$			300	ns	
SDATA, SCLOCK Fall Time, $t_7$			300	ns	
Setup Time (Stop Condition), $t_8$	0.6			$\mu\text{s}$	
<b>ANALOG OUTPUTS<sup>2</sup></b>					
Analog Output Delay		8		ns	
DAC Analog Output Skew		0.1		ns	
<b>CLOCK CONTROL AND PIXEL PORT<sup>3</sup></b>					
$f_{\text{CLOCK}}$		27		MHz	
Clock High Time, $t_9$	8			ns	
Clock Low Time, $t_{10}$	8			ns	
Data Setup Time, $t_{11}$	6			ns	
Data Hold Time, $t_{12}$	5			ns	
Control Setup Time, $t_{11}$	6			ns	
Control Hold Time, $t_{12}$	4			ns	
Digital Output Access Time, $t_{13}$		13		ns	
Digital Output Hold Time, $t_{14}$		12		ns	
Pipeline Delay, $t_{15}$ (2× Oversampling)		57		Clock Cycles	
Pipeline Delay, $t_{15}$ (4× Oversampling)		67		Clock Cycles	
<b>TELETEXT PORT<sup>4</sup></b>					
Digital Output Access Time, $t_{16}$		11		ns	
Data Setup Time, $t_{17}$		3		ns	
Data Hold Time, $t_{18}$		6		ns	
<b><math>\overline{\text{RESET}}</math> CONTROL</b>					
$\overline{\text{RESET}}$ Low Time		3	20	ns	
<b>PLL<sup>2</sup></b>					
PLL Output Frequency		54		MHz	

### NOTES

<sup>1</sup>Temperature range  $T_{MIN}$  to  $T_{MAX}$ : 0°C to 70°C.

<sup>2</sup>Guaranteed by characterization.

<sup>3</sup>Pixel Port consists of:

Data: P15–P0 Pixel Inputs,  
Control:  $\overline{\text{HSYNC}}$ ,  $\overline{\text{VSYNC}}$ ,  $\overline{\text{BLANK}}$ ,  
Clock: CLKIN Input.

<sup>4</sup>Teletext Port consists of:

Digital Output: TTXREQ,  
Data: TTX.

Specifications subject to change without notice.

### 3.3 V TIMING CHARACTERISTICS

( $V_{AA} = 3.3\text{ V} \pm 150\text{ mV}$ ,  $V_{REF} = 1.235\text{ V}$ ,  $R_{SET1,2} = 1200\ \Omega$ , unless otherwise noted. All specifications  $T_{MIN}$  to  $T_{MAX}$ <sup>1</sup>, unless otherwise noted<sup>2</sup>.)

Parameter	Min	Typ	Max	Unit	Test Conditions
<b>MPU PORT</b>					
SCLOCK Frequency	0		400	kHz	After This Period, the First Clock is Generated Relevant for Repeated Start Condition
SCLOCK High Pulsewidth, $t_1$	0.6			$\mu\text{s}$	
SCLOCK Low Pulsewidth, $t_2$	1.3			$\mu\text{s}$	
Hold Time (Start Condition), $t_3$	0.6			$\mu\text{s}$	
Setup Time (Start Condition), $t_4$	0.6			$\mu\text{s}$	
Data Setup Time, $t_5$	100			ns	
SDATA, SCLOCK Rise Time, $t_6$			300	ns	
SDATA, SCLOCK Fall Time, $t_7$			300	ns	
Setup Time (Stop Condition), $t_8$	0.6	2		$\mu\text{s}$	
<b>ANALOG OUTPUTS</b>					
Analog Output Delay		8		ns	
DAC Analog Output Skew		0.1		ns	
<b>CLOCK CONTROL AND PIXEL PORT<sup>3</sup></b>					
$f_{\text{CLOCK}}$		27		MHz	
Clock High Time, $t_9$	8			ns	
Clock Low Time, $t_{10}$	8			ns	
Data Setup Time, $t_{11}$	6			ns	
Data Hold Time, $t_{12}$	4			ns	
Control Setup Time, $t_{11}$	2.5			ns	
Control Hold Time, $t_{12}$	3			ns	
Digital Output Access Time, $t_{13}$		13		ns	
Digital Output Hold Time, $t_{14}$		12		ns	
Pipeline Delay, $t_{15}$ (2× Oversampling)		57		Clock Cycles	
Pipeline Delay, $t_{15}$ (4× Oversampling)		67		Clock Cycles	
<b>TELETEXT PORT<sup>4</sup></b>					
Digital Output Access Time, $t_{16}$		11		ns	
Data Setup Time, $t_{17}$		3		ns	
Data Hold Time, $t_{18}$		6		ns	
<b>RESET CONTROL</b>					
RESET Low Time		3	20	ns	
<b>PLL</b>					
PLL Output Frequency		54		MHz	

**NOTES**

<sup>1</sup>Temperature range  $T_{MIN}$  to  $T_{MAX}$ : 0°C to 70°C.

<sup>2</sup>Guaranteed by characterization.

<sup>3</sup>Pixel Port consists of:

Data: P15–P0 Pixel Inputs,  
Control:  $\overline{\text{HSYNC}}$ ,  $\overline{\text{VSYNC}}$ ,  $\overline{\text{BLANK}}$ ,  
Clock: CLKIN Input.

<sup>4</sup>Teletext Port consists of:

Digital Output: TTXREQ,  
Data: TTX.

Specifications subject to change without notice.

# ADV7190/ADV7191

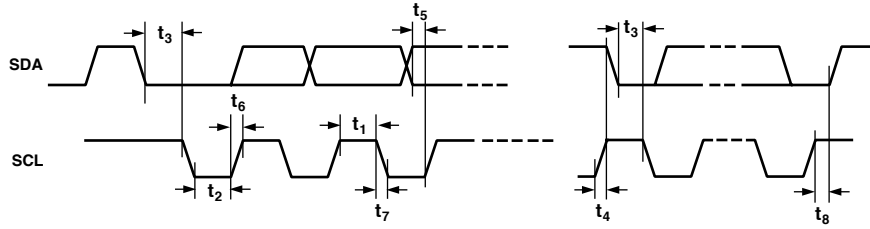

Figure 1. MPU Port Timing Diagram

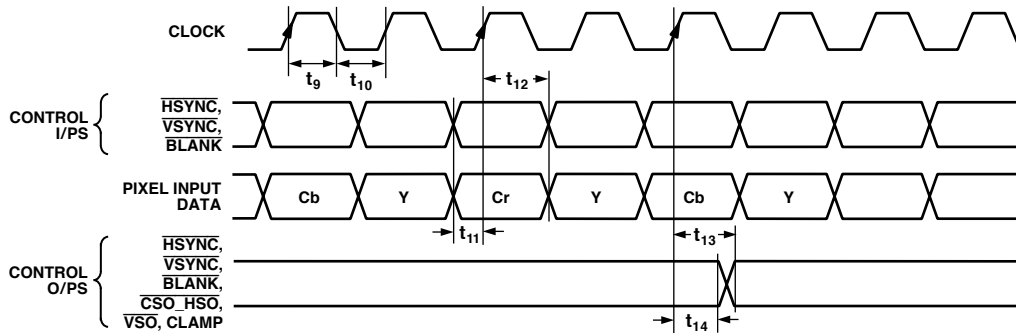

Figure 2. Pixel and Control Data Timing Diagram

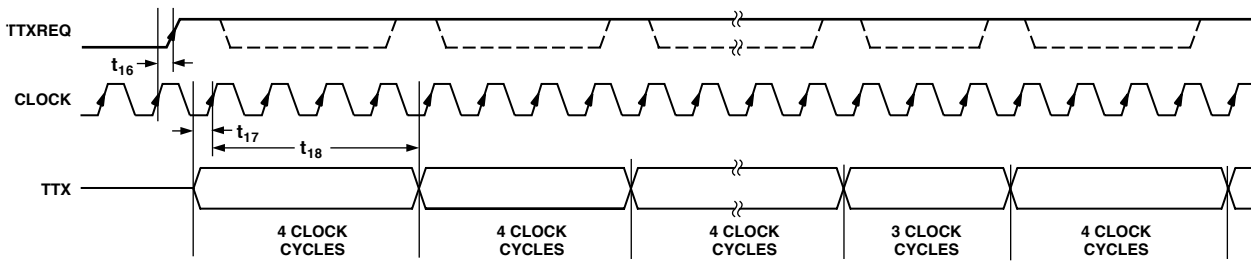

Figure 3. Teletext Timing Diagram



### ABSOLUTE MAXIMUM RATINGS<sup>1</sup>

V <sub>AA</sub> to GND	7 V
Voltage on Any Digital Input Pin	GND – 0.5 V to V <sub>AA</sub> + 0.5 V
Storage Temperature (T <sub>S</sub> )	–65°C to +150°C
Junction Temperature (T <sub>J</sub> )	150°C
Body Temperature (Soldering, 10 secs)	220°C
Analog Outputs to GND <sup>2</sup>	GND – 0.5 to V <sub>AA</sub>

### NOTES

<sup>1</sup>Stresses above those listed under Absolute Maximum Ratings may cause permanent damage to the device. This is a stress rating only; functional operation of the device at these or any other conditions above those listed in the operational sections of this specification is not implied. Exposure to absolute maximum rating conditions for extended periods may affect device reliability.

<sup>2</sup>Analog output short circuit to any power supply or common can be of an indefinite duration.

### PACKAGE THERMAL PERFORMANCE

The 64-lead package is used for this device. The junction-to-ambient (θ<sub>JA</sub>) thermal resistance in still air on a four-layer PCB is 38°C/W.

To reduce power consumption when using this part, the user can run the part on a 3.3 V supply, and turn off any unused DACs.

The user must at all times stay below the maximum junction temperature of 110°C. The following equation shows how to calculate this junction temperature:

$$Junction\ Temperature = (V_{AA} \times (I_{DAC} + I_{CCT})) \times \theta_{JA} + 70^{\circ}C\ T_{AMB}$$

$$I_{DAC} = 10\ mA + (\text{sum of the average currents consumed by each powered-on DAC})$$

$$\text{Average current consumed by each powered-on DAC} =$$

$$(V_{REF} \times K) / R_{SET}$$

$$V_{REF} = 1.235\ V$$

$$K = 4.2146$$

### PIN CONFIGURATION

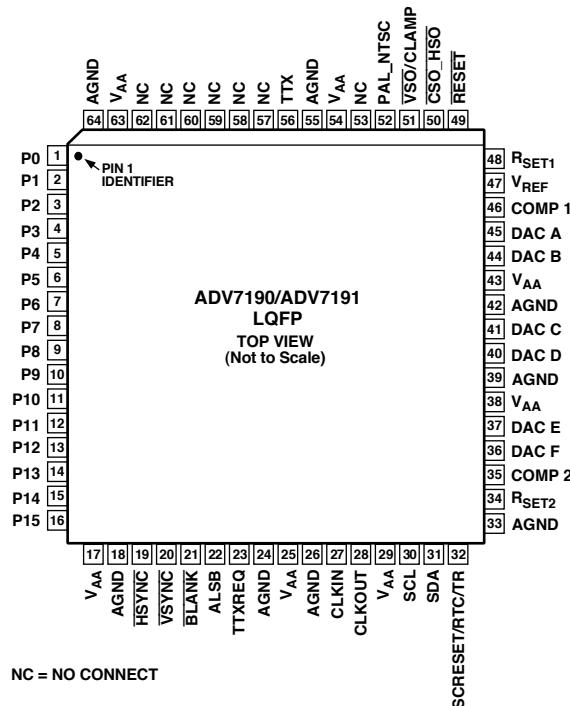

### ORDERING GUIDE

Model	Temperature Range	Package Description	Package Option
ADV7190KST	0°C to 70°C	64-Lead Quad Flatpack	ST-64
ADV7191KST	0°C to 70°C	64-Lead Quad Flatpack	ST-64

### CAUTION

ESD (electrostatic discharge) sensitive device. Electrostatic charges as high as 4000 V readily accumulate on the human body and test equipment and can discharge without detection. Although the ADV7190/ADV7191 features proprietary ESD protection circuitry, permanent damage may occur on devices subjected to high energy electrostatic discharges. Therefore, proper ESD precautions are recommended to avoid performance degradation or loss of functionality.



# ADV7190/ADV7191

## PIN FUNCTION DESCRIPTIONS

Pin No.	Mnemonic	Input/Output	Function
1–16	P0–P15	I	8-Bit or 16-Bit 4:2:2 Multiplexed YCrCb Pixel Port. The LSB of the input data is set up on Pin P0.
17, 25, 29, 38, 43, 54, 63	V <sub>AA</sub>	P	Analog Power Supply (3.3 V to 5 V).
18, 24, 26, 33, 39, 42, 55, 64	AGND	G	Analog Ground.
19	$\overline{\text{HSYNC}}$	I/O	$\overline{\text{HSYNC}}$ (Modes 1, 2, and 3) Control Signal. This pin may be configured to be an output (Master Mode) or an input (Slave Mode) and accept Sync Signals.
20	$\overline{\text{VSYNC}}$	I/O	$\overline{\text{VSYNC}}$ Control Signal. This pin may be configured as an output (Master Mode) or as an input (Slave Mode) and accept $\overline{\text{VSYNC}}$ as a Control Signal.
21	$\overline{\text{BLANK}}$	I/O	Video Blanking Control Signal. This signal is optional. For further information see Vertical Blanking Data Insertion and $\overline{\text{BLANK}}$ Input section.
22	ALSB	I	TTL Address Input. This signal sets up the LSB of the MPU address.
23	TTXREQ	O	Teletext Data Request Output Signal, used to control teletext data transfer.
27	CLKIN	I	TTL Clock Input. Requires a stable 27 MHz reference clock for standard operation. Alternatively, a 24.5454 MHz (NTSC) or 29.5 MHz (PAL) can be used for square pixel operation.
28	CLKOUT	O	Clock Output Pin.
30	SCL	I	MPU Port Serial Interface Clock Input.
31	SDA	I/O	MPU Port Serial Data Input/Output.
32	SCRESET/ RTC/TR	I	Multifunctional Input: Real-Time Control (RTC) Input, Timing Reset Input, Subcarrier Reset Input.
34	R <sub>SET2</sub>	I	A 1200 $\Omega$ resistor connected from this pin to ground is used to control full-scale amplitudes of the Video Signals from DACs D, E, and F.
35	COMP 2	O	Compensation Pin for DACs D, E, and F. Connect a 0.1 $\mu\text{F}$ Capacitor from COMP2 to V <sub>AA</sub> .
36	DAC F	O	S-Video C/V/RED Analog Output. This DAC is capable of providing 4.33 mA output.
37	DAC E	O	S-Video Y/U/BLUE Analog Output. This DAC is capable of providing 4.33 mA output.
40	DAC D	O	Composite/Y/GREEN Analog Output. This DAC is capable of providing 4.33 mA output.
41	DAC C	O	S-Video C/V/RED Analog Output. This DAC is capable of providing 4.33 mA output.
44	DAC B	O	S-Video Y/U/BLUE Analog Output. This DAC is capable of providing 4.33 mA output.
45	DAC A	O	Composite/Y/GREEN Analog Output. This DAC is capable of providing 4.33 mA output.
46	COMP 1	O	Compensation Pin for DACs A, B, and C. Connect a 0.1 $\mu\text{F}$ Capacitor from COMP1 to V <sub>AA</sub> .
47	V <sub>REF</sub>	I/O	Voltage Reference Input for DACs or Voltage Reference Output (1.235 V). An external V <sub>REF</sub> cannot be used in 4 $\times$ oversampling mode.
48	R <sub>SET1</sub>	I	A 1200 $\Omega$ resistor connected from this pin to ground is used to control full-scale amplitudes of the Video Signals from DACs A, B, and C.
49	$\overline{\text{RESET}}$	I	The input resets the on-chip timing generator and sets the ADV7190/ADV7191 into default mode. See Appendix 8 for Default Register settings.
50	$\overline{\text{CSO\_HSO}}$	O	Dual Function $\overline{\text{CSO}}$ or $\overline{\text{HSO}}$ Output Sync Signal at TTL Level.
51	$\overline{\text{VSO/CLAMP}}$	I/O	Multifunction Pin. $\overline{\text{VSO}}$ Output Sync Signal at TTL level. CLAMP TTL Output Signals can be used to drive external circuitry to enable clamping of all Video Signals.
52	PAL_NTSC	I	Input signal to select PAL or NTSC mode of operation, pin set to Logic 1 selects PAL.
53, 57–62	NC		No Connect.
56	TTX	I	Teletext Data Input Pin.

## DETAILED DESCRIPTION OF FEATURES

### Clocking:

- Single 27 MHz Clock Required to Run the Device
- 4x Oversampling with Internal 54 MHz PLL
- Square Pixel Operation

### Advanced Power Management

### Programmable Video Control Features:

- Digital Noise Reduction
- Pedestal level
- Hue, Brightness, Contrast and Saturation
- Clamping Output Signal
- VBI (Vertical Blanking Interval)
- Subcarrier Frequency and Phase
- LUMA Delay
- CHROMA Delay
- Gamma Correction
- Luma and Chroma Filters
- Luma SSAF (Super Subalias Filter)
- Average Brightness Detection
- Field Counter
- Interlaced/Noninterlaced Operation
- Complete On-Chip Video Timing Generator
- Programmable Multimode Master/Slave Operation
- CGMS (Copy Generation Management System)
- WSS (Wide Screen Signaling)
- Macrovision 7.1 Rev (ADV7190 Only)
- Closed Captioning Support
- Teletext Insertion Port (PAL-WST)
- 2-Wire Serial MPU Interface
- I<sup>2</sup>C Registers Synchronized to VSYNC

Six DACs are available on the ADV7190/ADV7191, each of which is capable of providing 4.33 mA of current. In addition to the composite output signal there is the facility to output S-Video (Y/C Video), RGB Video and YUV Video. All YUV formats (Betacam, MII and (SMPTE/EBU N10) are supported.

Digital Noise Reduction allows improved picture quality in removing low amplitude, high frequency noise. The block diagram below shows the DNR functionality in the two modes available.

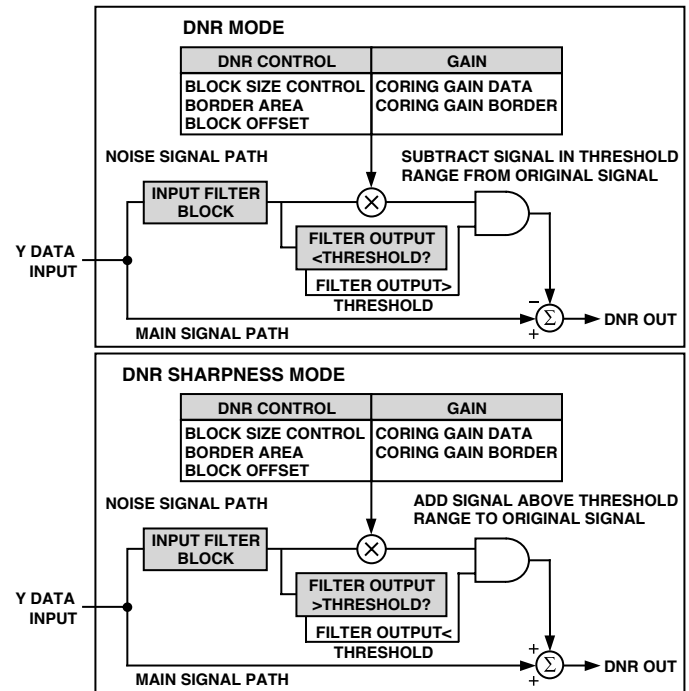

Figure 5. Block Diagram for DNR Mode and DNR Sharpness Mode

(continued from page 1)

## GENERAL DESCRIPTION

The ADV7190/ADV7191 is an integrated Digital Video Encoder that converts digital CCIR-601/656 4:2:2 8-bit or 16-bit component video data into a standard analog baseband television signal compatible with worldwide standards.

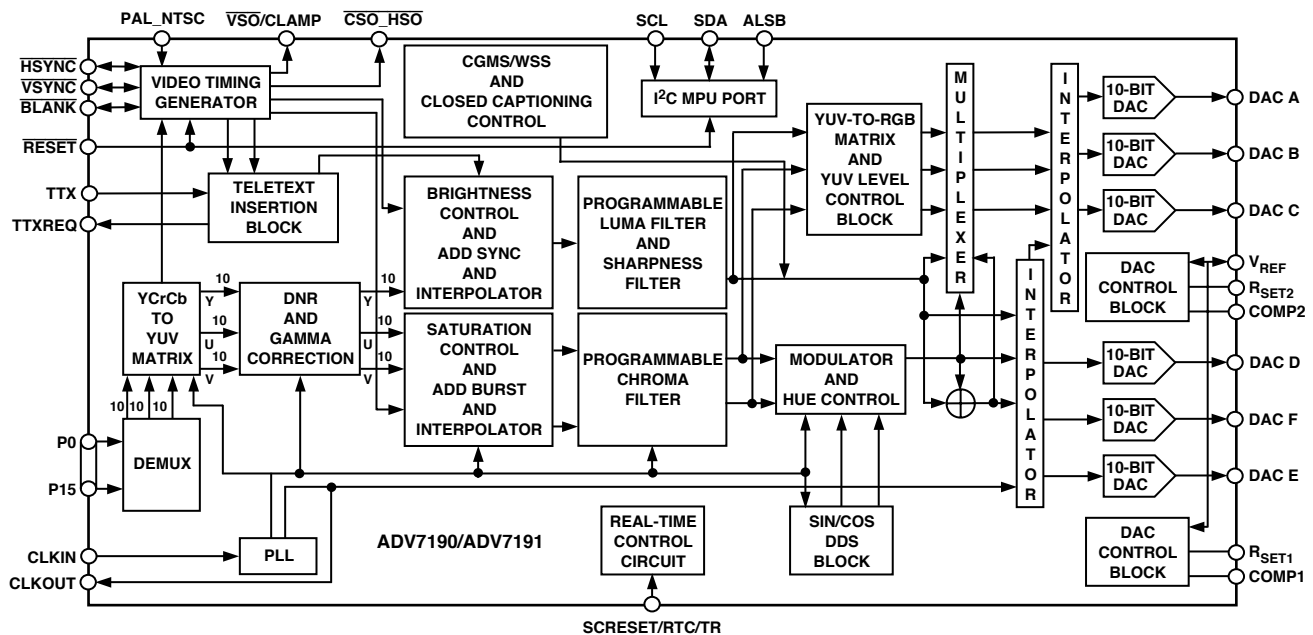

Figure 4. Detailed Functional Block Diagram

# ADV7190/ADV7191

Programmable gamma correction is also available. Figure 6 shows the response of different gamma values to a ramp signal.

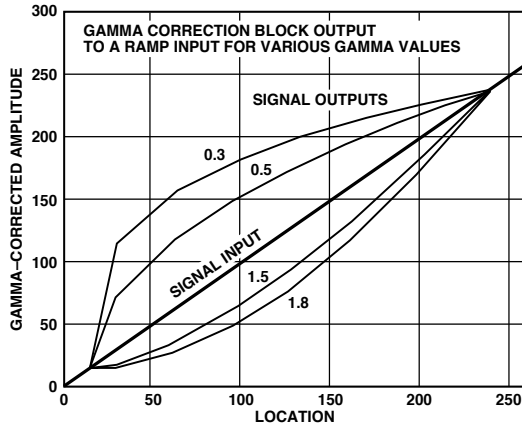

Figure 6. Signal Input (Ramp) and Selectable Gamma Output Curves

The on-board SSAF (Super Subalias Filter) with extended luminance frequency response and sharp stopband attenuation enables studio quality video playback on modern TVs, giving optimal horizontal line resolution. An additional sharpness control feature allows high-frequency enhancement on the luminance signal.

The device is driven by a 27 MHz clock. Data can be output at 27 MHz or 54 MHz (on-board PLL) when 4x oversampling is enabled. Also, the output filter requirements in 4x oversampling and 2x oversampling differ, as can be seen in Figure 7.

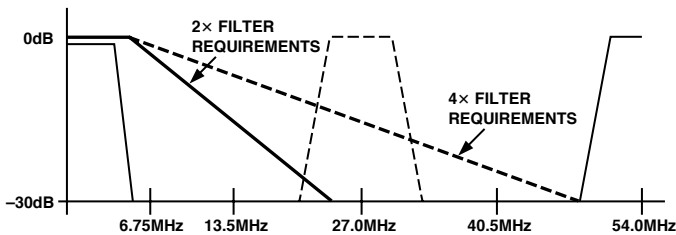

Figure 7. Output Filter Requirements in 4x Oversampling Mode

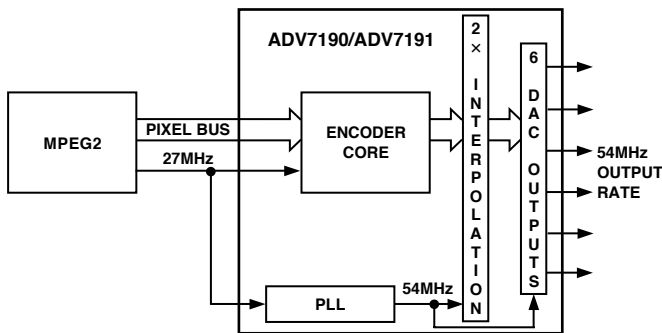

Figure 8. PLL and 4x Oversampling Block Diagram

The ADV7190/ADV7191 also supports both PAL and NTSC square pixel operation. In this case the encoder requires a 24.5454 MHz Clock for NTSC or 29.5 MHz Clock for PAL square pixel mode operation. All internal timing is generated on-chip.

An advanced power management circuit enables optimal control of power consumption in normal operating modes or sleep modes.

The Output Video Frames are synchronized with the incoming data Timing Reference Codes. Optionally, the Encoder accepts (and can generate)  $\overline{\text{HSYNC}}$ ,  $\overline{\text{VSYNC}}$ , and  $\overline{\text{FIELD}}$  timing signals. These timing signals can be adjusted to change pulsewidth and position while the part is in master mode.

$\overline{\text{HSO/CSO}}$  and  $\overline{\text{VSO}}$  TTL outputs are also available and are timed to the analog output video.

A separate teletext port enables the user to directly input teletext data during the vertical blanking interval.

The ADV7190/ADV7191 also incorporates WSS and CGMS-A data control generation. The ADV7190 incorporates Macrovision Rev 7.1.

The ADV7190/ADV7191 modes are set up over a 2-wire serial bidirectional port (I<sup>2</sup>C-compatible) with two slave addresses, and the device is register-compatible with the ADV7172/ADV7173.

The ADV7190/ADV7191 is packaged in a 64-lead LQFP package.

## DATA PATH DESCRIPTION

For PAL B, D, G, H, I, M, N, and NTSC M, N modes, YCrCb 4:2:2 Data is input via the CCIR-656/601-compatible Pixel Port at a 27 MHz data rate. The pixel data is demultiplexed to form three data paths. Y typically has a range of 16 to 235, Cr and Cb typically have a range of 128+/-112; however, it is possible to input data from 1 to 254 on both Y, Cb, and Cr. The ADV7190/ADV7191 supports PAL (B, D, G, H, I, N) and NTSC M, N (with and without Pedestal) PAL.M (ADV7190 only) and PAL60 standards. Digital Noise Reduction can be applied to the Y signal. Programmable gamma correction can also be applied to the Y signal if required.

The Y data can be manipulated for contrast control and a set-up level can be added for brightness control. The Cr, Cb data can be scaled to achieve color saturation control. All settings become effective at the start of the next field when double buffering is enabled.

The appropriate sync, blank, and burst levels are added to the YCrCb data. Macrovision antitaping, (ADV7190 only) Closed-Captioning, and Teletext levels are also added to Y and the resultant data is interpolated to 54 MHz when 4x Oversampling is enabled. The interpolated data is filtered and scaled by three digital FIR filters.

The U and V signals are modulated by the appropriate Subcarrier Sine/Cosine waveforms and a phase offset may be added onto the color subcarrier during active video to allow hue adjustment. The resulting U and V signals are added together to make up the Chrominance Signal. The Luma (Y) signal can be delayed by up to six clock cycles (at 27 MHz) and the Chroma signal can be delayed by up to eight clock cycles (at 27 MHz). The

Luma and Chroma Signals are added together to make up the Composite Video Signal. All timing signals are controlled.

The YCrCb data is also used to generate RGB data with appropriate sync and blank levels. The YUV levels are scaled to output the suitable SMPTE/EBU N10, MII, or Betacam levels.

Each DAC can be individually powered off if not required. A complete description of DAC output configurations is given in the MR2 Bit Description section.

Video output levels are illustrated in Appendix 9.

**INTERNAL FILTER RESPONSE**

The Y Filter supports several different frequency responses including two low-pass responses, two notch responses, an Extended (SSAF) response with or without gain boost/attenuation, a CIF response and a QCIF response. The UV Filter supports several different frequency responses including five low-pass responses, a CIF response and a QCIF response, as can be seen on the following pages.

In Extended Mode there is the option of twelve responses in the range from -4 dB to +4 dB. The desired response can be chosen by the user by programming the correct value via the I<sup>2</sup>C. The variation of frequency responses can be seen on the following pages. For more detailed plots refer to AN-562 Analog Devices' Application note.

**Table I. Luminance Internal Filter Specifications (4× Oversampling)**

Filter Type	Filter Selection			Passband Ripple <sup>1</sup> (dB)	3 dB Bandwidth <sup>2</sup> (MHz)
	MR04	MR03	MR02		
Low-Pass (NTSC)	0	0	0	0.16	4.24
Low-Pass (PAL)	0	0	1	0.1	4.81
Notch (NTSC)	0	1	0	0.09	2.3/4.9/6.6
Notch (PAL)	0	1	1	0.1	3.1/5.6/6.4
Extended (SSAF)	1	0	0	0.04	6.45
CIF	1	0	1	0.127	3.02
QCIF	1	1	0	Monotonic	1.5

NOTES

<sup>1</sup>Passband ripple is defined to be fluctuations from the 0 dB response in the passband, measured in (dB). The passband is defined to have 0-fc frequency limits for a low-pass filter, 0-f1 and f2-infinity for a notch filter, where fc, f1, f2 are the -3 dB points.

<sup>2</sup>3 dB bandwidth refers to the -3 dB cutoff frequency.

**Table II. Chrominance Internal Filter Specifications (4× Oversampling)**

Filter Type	Filter Selection			Passband Ripple <sup>1</sup> (dB)	3 dB Bandwidth <sup>2</sup> (MHz)
	MR07	MR06	MR05		
1.3 MHz Low-Pass	0	0	0	0.09	1.395
0.65 MHz Low-Pass	0	0	1	Monotonic	0.65
1.0 MHz Low-Pass	0	1	0	Monotonic	1.0
2.0 MHz Low-Pass	0	1	1	0.048	2.2
3.0 MHz Low-Pass	1	1	1	Monotonic	3.2
CIF	1	0	1	Monotonic	0.65
QCIF	1	1	0	Monotonic	0.5

NOTES

<sup>1</sup>Passband ripple is defined to be fluctuations from the 0 dB response in the passband, measured in (dB). The passband is defined to have 0-fc frequency limits for a low-pass filter, 0-f1 and f2-infinity for a notch filter, where fc, f1, f2 are the -3 dB points.

<sup>2</sup>3 dB bandwidth refers to the -3 dB cutoff frequency.

# ADV7190/ADV7191

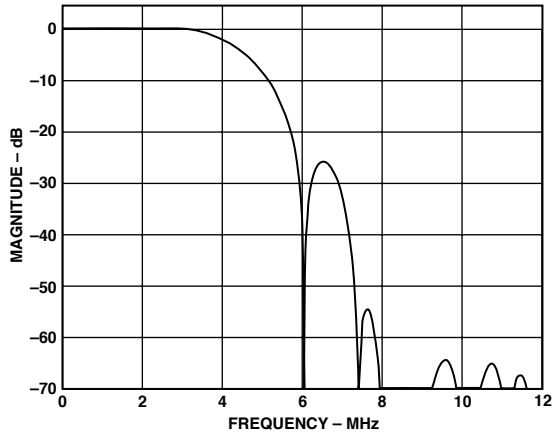

Figure 9. NTSC Low-Pass Luma Filter

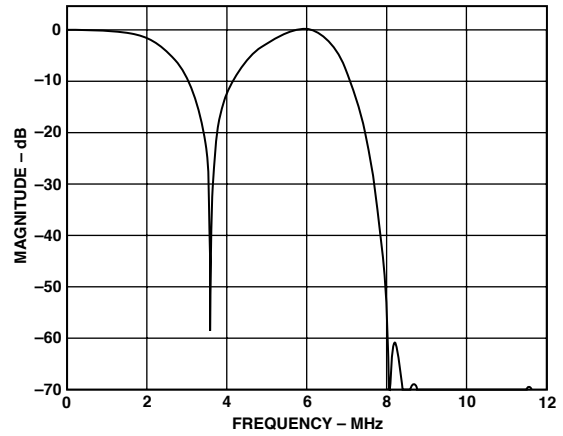

Figure 12. NTSC Notch Luma Filter

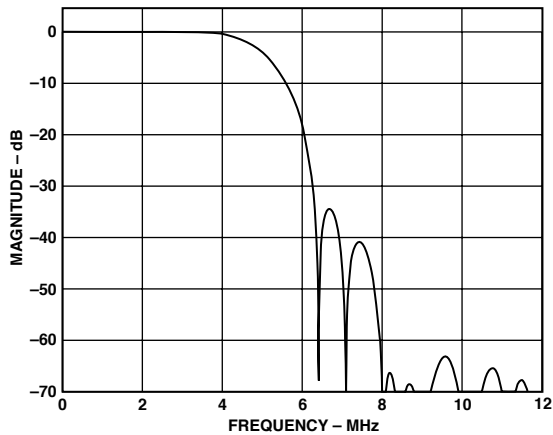

Figure 10. PAL Low-Pass Luma Filter

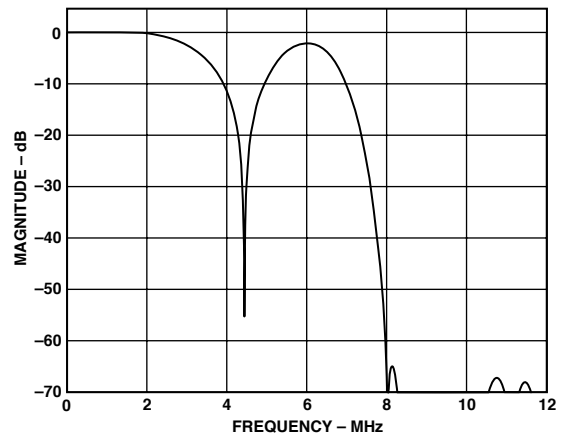

Figure 13. PAL Notch Luma Filter

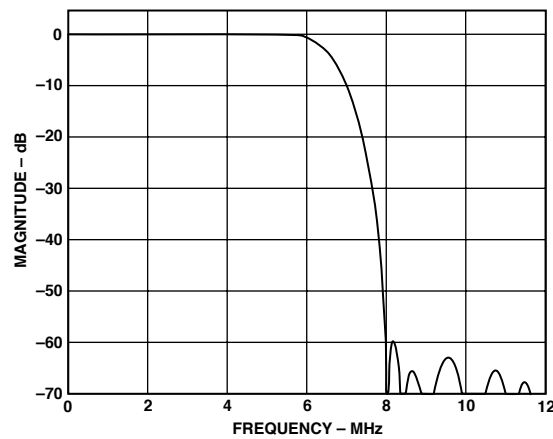

Figure 11. Extended Mode (SSAF) Luma Filter

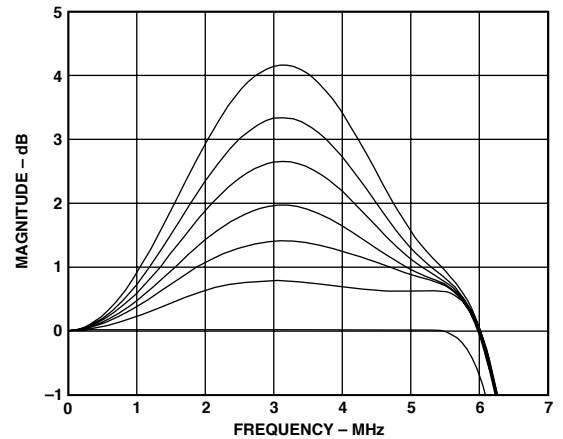

Figure 14. Extended SSAF and Programmable Gain, Showing Range 0 dB/+4 dB Range

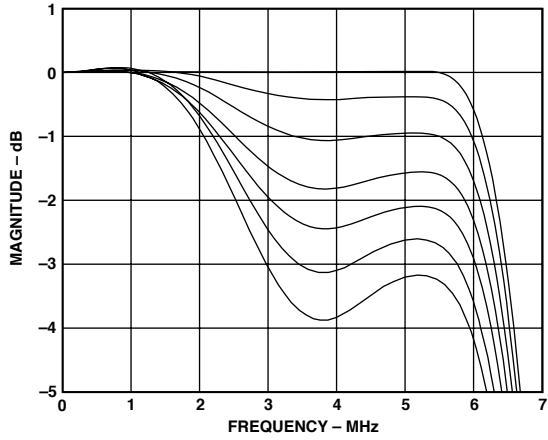

Figure 15. Extended SSAF and Programmable Attenuation, Showing Range 0 dB/-4 dB

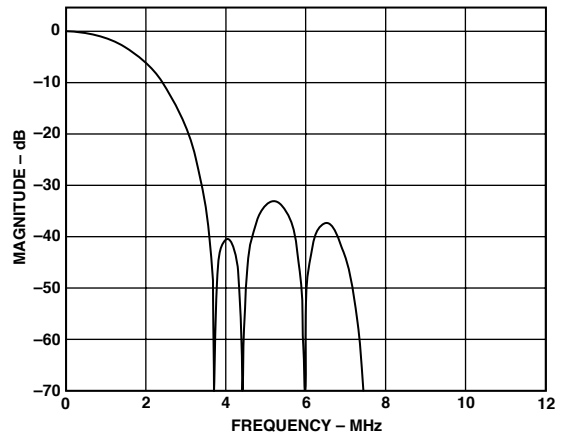

Figure 18. QCIF Filter

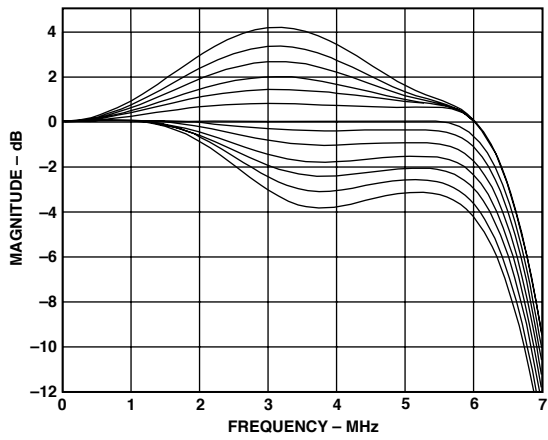

Figure 16. Extended SSAF and Programmable Attenuation, Showing Range +4 dB/-12 dB

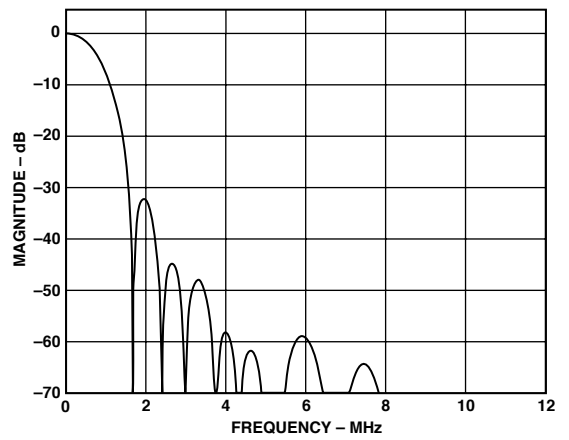

Figure 19. Chroma 0.65 MHz Low-Pass Filter

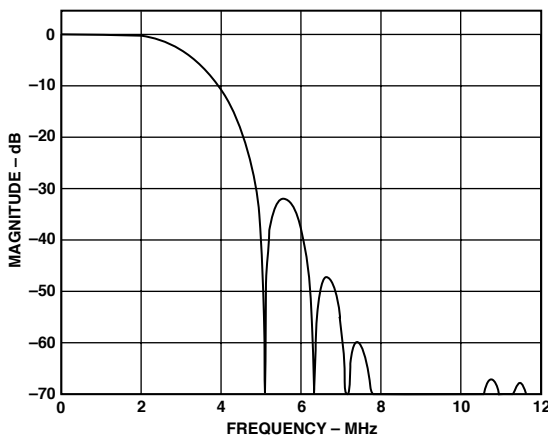

Figure 17. Luma CIF Filter

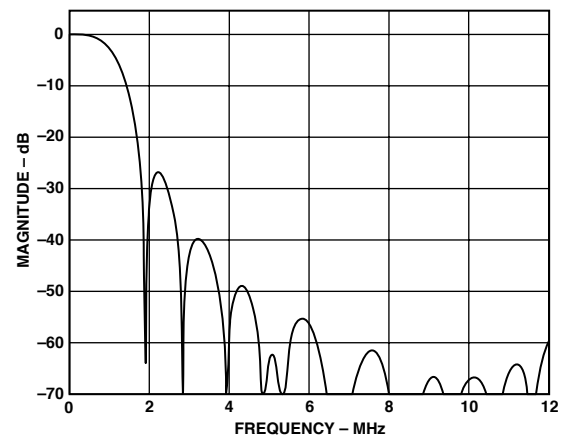

Figure 20. Chroma 1.0 MHz Low-Pass Filter

# ADV7190/ADV7191

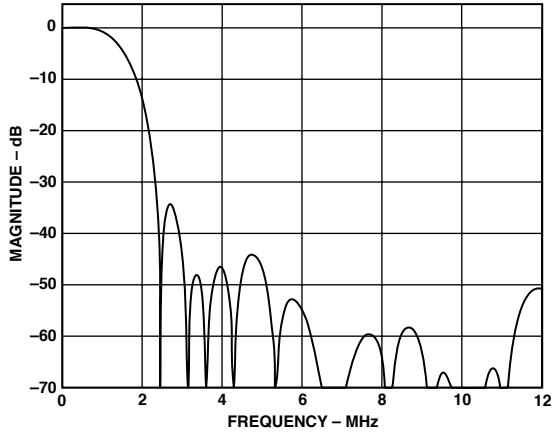

Figure 21. Chroma 1.3 MHz Low-Pass Filter

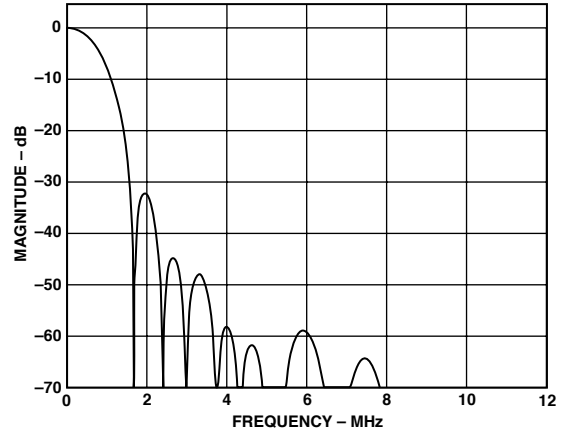

Figure 24. Chroma CIF Filter

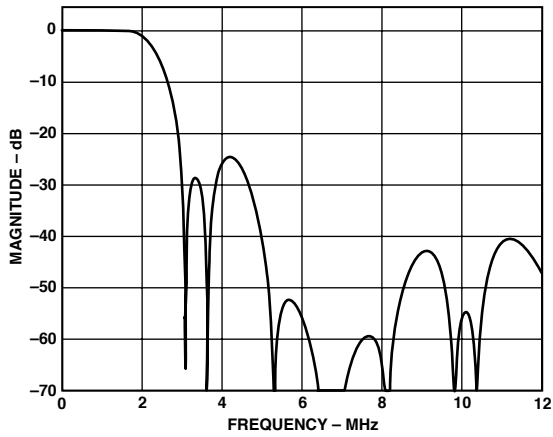

Figure 22. Chroma 2 MHz Low-Pass Filter

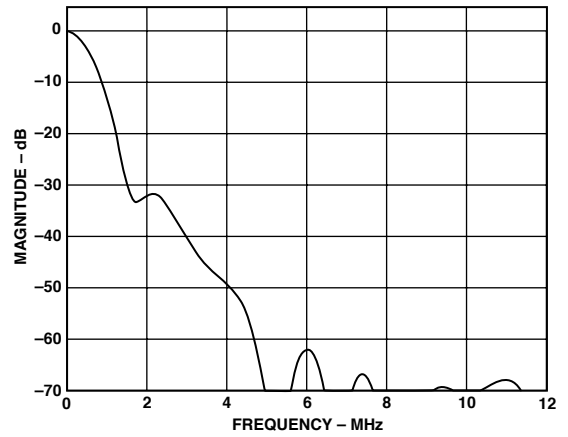

Figure 25. Chroma QCIF Filter

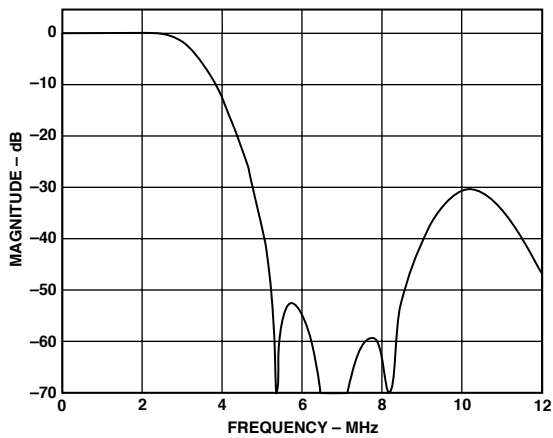

Figure 23. Chroma 3 MHz Low-Pass Filter



## FEATURES: FUNCTIONAL DESCRIPTION

### Brightness Detect

This feature is used to monitor the average brightness of the incoming Y signal on a field-by-field basis. The information is read from the I<sup>2</sup>C and based on this information, the color saturation, contrast and brightness controls can be adjusted (for example to compensate for very dark pictures). (Brightness Detect Register.)

### Chroma/Luma Delay

The luminance data can be delayed by maximum of six clock cycles. Additionally the Chroma can be delayed by a maximum of eight clock cycles (one clock cycle at 27 MHz). (Timing Register 0 and Mode Register 9.)

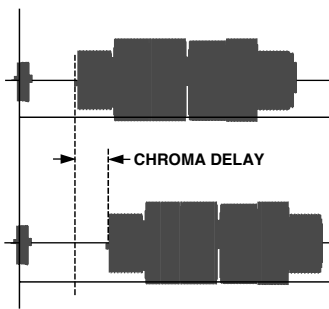

Figure 26. Chroma Delay

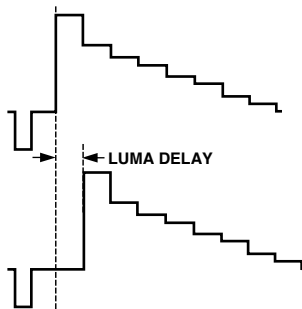

Figure 27. Luma Delay

### Clamp Output

The ADV7190/ADV7191 has a programmable clamp TTL output signal. This clamp signal is programmable to the front and back porch. The clamp signal can be varied by one to three clock cycles in a positive and negative direction from the default position. (Mode Register 5, Mode Register 7.)

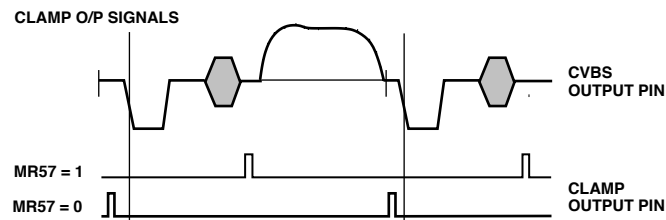

Figure 28. Clamp Output Timing

### CSO, HSO, and VSO Outputs

The ADV7190/ADV7191 supports three output timing signals,  $\overline{\text{CSO}}$  (Composite Sync Signal),  $\overline{\text{HSO}}$  (Horizontal Sync Signal) and  $\overline{\text{VSO}}$  (Vertical Sync Signal). These output TTL signals are aligned with the analog video outputs. See Figure 29 for an example of these waveforms. (Mode Register 7.)

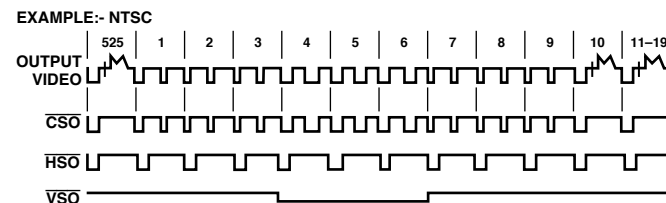

Figure 29.  $\overline{\text{CSO}}$ ,  $\overline{\text{HSO}}$ ,  $\overline{\text{VSO}}$  Timing Diagram

### Color Bar Generation

The ADV7190/ADV7191 can be configured to generate 100/7.5/75/7.5 color bars for NTSC or 100/0/75/0 color bars for PAL. (Mode Register 4.)

### Color Burst Signal Control

The burst information can be switched on and off the composite and chroma video output. (Mode Register 4.)

### Color Controls

The ADV7190/ADV7191 allows the user to control the brightness, contrast, hue, and saturation of the color. The control registers may be double-buffered, meaning that any modification to the registers will be done outside the active video region and, therefore, changes made will not be visible during active video.

### Contrast Control

Contrast adjustment is achieved by scaling the Y input data by a factor programmed by the user. This factor allows the data to be scaled between 0% and 150%. (Contrast Control Register.)

### Brightness Control

The brightness is controlled by adding a programmable setup level onto the scaled Y data.

For NTSC with pedestal, the setup can vary from 0 IRE to 22.5 IRE. For NTSC without pedestal and PAL, the setup can vary from -7.5 IRE to +15 IRE. (Brightness Control Register.)

### Color Saturation

Color adjustment is achieved by scaling the Cr and Cb input data by a factor programmed by the user. This factor allows the data to be scaled between 0% and 200%. (U Scale Register and V Scale Register.)

### Hue Adjust Control

The hue adjustment is achieved on the composite and chroma outputs by adding a phase offset onto the color subcarrier in the active video but leaving the color burst unmodified, i.e., only the phase between the video and the colorburst is modified and thus the hue is shifted. The ADV7190/ADV7191 provides a range of  $\pm 22^\circ$  in increments of  $0.17578125^\circ$ . (Hue Adjust Register.)

### Chrominance Control

The color information can be switched on and off the composite, chroma and color component video outputs. (Mode Register 4.)

### Undershoot Limiter

A limiter is placed after the digital filters. This prevents any synchronization problems for TVs. The level of undershoot is programmable between -1.5 IRE, -6 IRE, -11 IRE when operating in 4 $\times$  Oversampling. In 2 $\times$  Oversampling mode the limits are -7.5 IRE and 0 IRE. (Mode Register 9 and Timing Register 0.)

### Digital Noise Reduction

DNR is applied to the Y data only. A filter block selects the high frequency, low amplitude components of the incoming signal (DNR Input Select). The absolute value of the filter output is compared to a programmable threshold value (DNR Threshold Control).

Two DNR modes are available: DNR Mode and DNR Sharpness Mode.

# ADV7190/ADV7191

In DNR Mode, if the absolute value of the filter output is smaller than the threshold, it is assumed to be noise. A programmable amount (Coring Gain Control) of this noise signal will be subtracted from the original signal.

In DNR Sharpness Mode, if the absolute value of the filter output is less than the programmed threshold, it is assumed to be noise, as before. Otherwise, if the level exceeds the threshold, now being identified as a valid signal, a fraction of the signal (Coring Gain Control) will be added to the original signal in order to boost high frequency components and to sharpen the video image.

In MPEG systems it is common to process the video information in blocks of  $8 \times 8$  pixels for MPEG2 systems, or  $16 \times 16$  pixels for MPEG1 systems (Block Size Control). DNR can be applied to the resulting block transition areas that are known to contain noise. Generally the block transition area contains two pixels. It is possible to define this area to contain four pixels (Border Area Control).

It is also possible to compensate for variable block positioning or differences in YCrCb pixel timing with the use of the (Block Offset Control). See Figure 82 for further information. (Mode Register 8, DNR Registers 0–2.)

## Double Buffering

Double buffering can be enabled or disabled on the following registers: Closed Captioning Registers, Brightness Control, V Scale, U Scale, Contrast Control, Hue Adjust, the Gamma Curve Select bit, and Macrovision Registers (ADV7190 only). These registers are updated once per field on the falling edge of the  $\overline{\text{VSYNC}}$  signal. Double buffering improves the overall performance of the ADV7190/ADV7191, since modifications to register settings will not be made during active video, but take effect on the start of the active video. (Mode Register 8.)

## Gamma Correction Control

Gamma correction may be performed on the luma data. The user has the choice to use either of two different gamma curves, A or B. At any one time one of these curves is operational if gamma correction is enabled. Gamma correction allows the mapping of the luma data to a user-defined function. (See Gamma Correction Registers 0–13 section.) (Mode Register 8, Gamma Correction Registers 0–13.)

## NTSC Pedestal Control

In NTSC mode it is possible to have the pedestal signal generated on the output video signal. (Mode Register 2.)

## Power-On Reset

After power-up, it is necessary to execute a  $\overline{\text{RESET}}$  operation. A reset occurs on the falling edge of a high-to-low transition on the  $\overline{\text{RESET}}$  pin. This initializes the pixel port such that the data on the pixel input pins is ignored. See Appendix 8 for the register settings after  $\overline{\text{RESET}}$  is applied.

## Real-Time Control, Subcarrier Reset, and Timing Reset

Together with the SCRESET/RTC/TR pin of Mode Register 4 (Genlock Control), the ADV7190/ADV7191 can be used in (a) Timing Reset Mode, (b) Subcarrier Phase Reset Mode or (c) RTC Mode.

- (a) A TIMING RESET is achieved in holding this pin high. In this state the horizontal and vertical counters will remain reset. On releasing this pin (set to low), the internal counters will

commence counting again. The minimum time the pin has to be held high is 37 ns (1 clock cycle at 27 MHz), otherwise the reset signal might not be recognized.

- (b) The SUBCARRIER PHASE will reset to that of Field 0 at the start of the following field when a low-to-high transition occurs on this input pin.
- (c) In RTC MODE, the ADV7190/ADV7191 can be used to lock to an external video source.

The real-time control mode allows the ADV7190/ADV7191 to automatically alter the subcarrier frequency to compensate for line length variations. When the part is connected to a device that outputs a digital datastream in the RTC format such as an ADV7185 video decoder (see Figure 32), the part will automatically change to the compensated subcarrier frequency on a line-by-line basis. This digital datastream is 67 bits wide and the subcarrier is contained in Bits 0 to 21. Each bit is two clock cycles long. 00Hex should be written into all four Subcarrier Frequency registers when using this mode. It is recommended to use the ADV7185 in this mode. (Mode Register 4.)

## SCH Phase Mode

The SCH phase is configured in default mode to reset every four (NTSC) or eight (PAL) fields to avoid an accumulation of SCH phase error over time. In an ideal system, zero SCH phase error would be maintained forever, but in reality, this is impossible to achieve due to clock frequency variations. This effect is reduced by the use of a 32-bit DDS, which generates this SCH.

Resetting the SCH phase every four or eight fields avoids the accumulation of SCH phase error, and results in very minor SCH phase jumps at the start of the four or eight field sequence.

Automatically resetting the SCH phase should not be done if the video source does not have stable timing or the ADV7190/ADV7191 is configured in RTC mode. Under these conditions (unstable video) the Subcarrier Phase Reset should be enabled but no reset applied. In this configuration the SCH Phase will never be reset; this means that the output video will now track the unstable input video.

The Subcarrier Phase Reset, when applied, will reset the SCH phase to Field 0 at the start of the next field (e.g., Subcarrier Phase Reset applied in Field 5 (PAL) on the start of the next field SCH phase will be reset to Field 0). (Mode Register 4.)

## Sleep Mode

If, after  $\overline{\text{RESET}}$ , the SCRESET/RTC/TR and NTSC\_PAL pins are both set high, the ADV7190/ADV7191 will power up in Sleep Mode to facilitate low power consumption before all registers have been initialized. If Power-Up in Sleep Mode is disabled, Sleep Mode control passes to the Sleep Mode control in Mode Register 2 (i.e., control via I<sup>2</sup>C). (Mode Register 2 and Mode Register 6.)

## Square Pixel Mode

The ADV7190/ADV7191 can be used to operate in square pixel mode. For NTSC operation an input clock of 24.5454 MHz is required. Alternatively, for PAL operation, an input clock of 29.5 MHz is required. The internal timing logic adjusts accordingly for square pixel mode operation. Square pixel mode is not available in  $4 \times$  Oversampling mode. (Mode Register 2.)

## Vertical Blanking Data Insertion and $\overline{\text{BLANK}}$ Input

It is possible to allow encoding of incoming YCbCr data on those lines of VBI that do not have line sync or pre-/post-equalization pulses (see Figures 34 to 45). This mode of operation is called *Partial Blanking*. It allows the insertion of any VBI data (Opened VBI) into the encoded output waveform. This data is present in digitized incoming YCbCr data stream (e.g., WSS data, CGMS, VPS etc.). Alternatively, the entire VBI may be blanked (no VBI data inserted) on these lines. VBI is available in all timing modes.

It is possible to allow control over the  $\overline{\text{BLANK}}$  signal using Timing Register 0. When the  $\overline{\text{BLANK}}$  input is enabled (TR03 = 0 and input pin tied low), the  $\overline{\text{BLANK}}$  input can be used to input externally generated blank signals in Slave Mode 1, 2, or 3. When the  $\overline{\text{BLANK}}$  input is disabled (TR03 = 1 and input pin tied low or tied high), the  $\overline{\text{BLANK}}$  input is not used and the ADV7190/ADV7191 automatically blanks all normally blank lines as per CCIR-624. (Timing Register 0.)

## YUV Levels

This functionality allows the ADV7190/ADV7191 to output SMPTE levels or Betacam levels on the Y output when configured in PAL or NTSC mode.

	Sync	Video
Betacam	286 mV	714 mV
SMPTE	300 mV	700 mV
MII	300 mV	700 mV

As the data path is branched at the output of the filters the luma signal relating to the CVBS or S-Video Y/C output is unaltered. It is only the Y output of the YCrCb outputs that is scaled. This control allows color component levels to have a peak-peak amplitude of 700 mV, 1000 mV or the default values of 934 mV in NTSC and 700 mV in PAL. (Mode Register 5.)

## 16-Bit Interface

It is possible to input data in 16-bit format. In this case, the interface only operates if the data is accompanied by separate  $\overline{\text{HSYNC}}$ / $\overline{\text{VSYNC}}$ / $\overline{\text{BLANK}}$  signals. Sixteen-bit mode is not available in Slave Mode 0 since EAV/SAV timing codes are used. (Mode Register 8.)

## 4× Oversampling and Internal PLL

It is possible to operate all six DACs at 27 MHz (2× Oversampling) or 54 MHz (4× Oversampling).

The ADV7190/ADV7191 is supplied with a 27 MHz clock synced with the incoming data. Two options are available: to run the device throughout at 27 MHz or to enable the PLL. In the latter case, even if the incoming data runs at 27 MHz, 4× Oversampling and the internal PLL will output the data at 54 MHz.

## NOTE

In 4× Oversampling Mode the requirements for the optional output filters are different from those in 2× Oversampling. (Mode Register 1, Mode Register 6.) See Appendix 6 for further details.

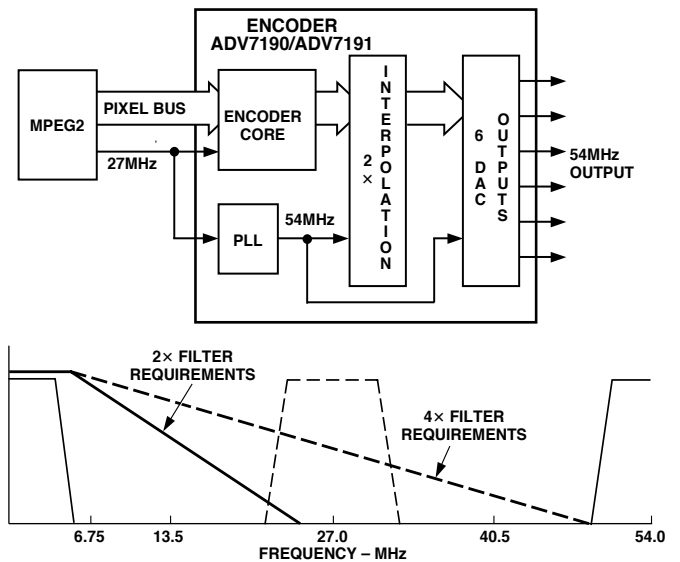

Figure 30. PLL and 4× Oversampling Block Diagram

## VIDEO TIMING DESCRIPTION

The ADV7190/ADV7191 is intended to interface to off-the-shelf MPEG1 and MPEG2 Decoders. As a consequence, the ADV7190/ADV7191 accepts 4:2:2 YCrCb Pixel Data via a CCIR-656 Pixel Port and has several Video Timing Modes of operation that allow it to be configured as either System Master Video Timing Generator or a Slave to the System Video Timing Generator. The ADV7190/ADV7191 generates all of the required horizontal and vertical timing periods and levels for the analog video outputs.

The ADV7190/ADV7191 calculates the width and placement of analog sync pulses, blanking levels, and color burst envelopes. Color bursts are disabled on appropriate lines and serration and equalization pulses are inserted where required.

In addition, the ADV7190/ADV7191 supports a PAL or NTSC square pixel operation. The part requires an input pixel clock of 24.5454 MHz for NTSC square pixel operation and an input pixel clock of 29.5 MHz for PAL square pixel operation. The internal horizontal line counters place the various video waveform sections in the correct location for the new clock frequencies.

The ADV7190/ADV7191 has four distinct Master and four distinct Slave timing configurations. Timing Control is established with the bidirectional  $\overline{\text{HSYNC}}$ ,  $\overline{\text{BLANK}}$ , and  $\overline{\text{VSYNC}}$  pins. Timing Register 1 can also be used to vary the timing pulsewidths and where they occur in relation to each other. (Mode Register 2, Timing Register 0, 1.)

## RESET SEQUENCE

When RESET becomes active the ADV7190/ADV7191 reverts to the default output configuration (see Appendix 8 for register settings). The ADV7190/ADV7191 internal timing is under the control of the logic level on the NTSC\_PAL pin.

# ADV7190/ADV7191

When  $\overline{\text{RESET}}$  is released Y, Cr, Cb values corresponding to a black screen are input to the ADV7190/ADV7191. Output timing signals are still suppressed at this stage. DACs A, B, C are switched off and DACs D, E, F are switched on.

When the user requires valid data, Pixel Data Valid Control is enabled ( $\text{MR26} = 1$ ) to allow the valid pixel data to pass through the encoder. Digital output timing signals become active and the encoder timing is now under the control of the Timing Registers. If at this stage, the user wishes to select a different video standard

to that on the NTSC\_PAL pin, Standard I<sup>2</sup>C Control should be enabled ( $\text{MR25} = 1$ ) and the video standard required is selected by programming Mode Register 0 (Output Video Standard Selection). Figure 31 illustrates the  $\overline{\text{RESET}}$  sequence timing.

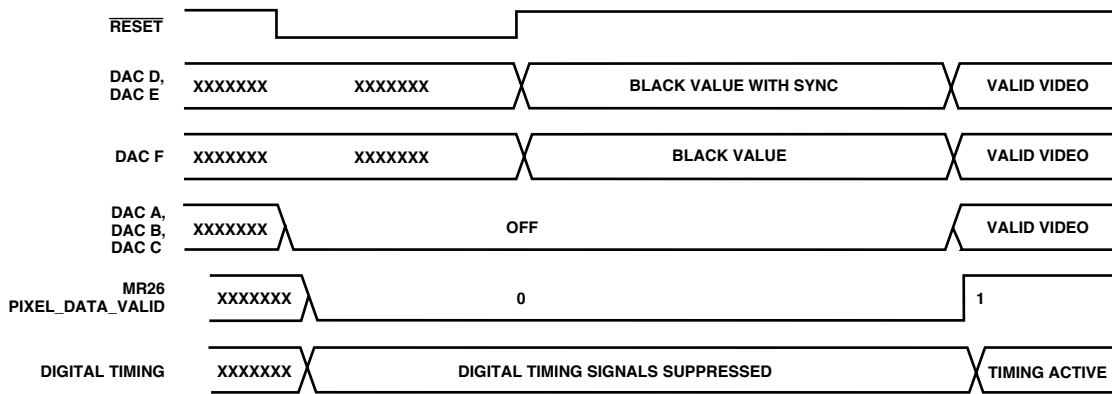

Figure 31.  $\overline{\text{RESET}}$  Sequence Timing Diagram

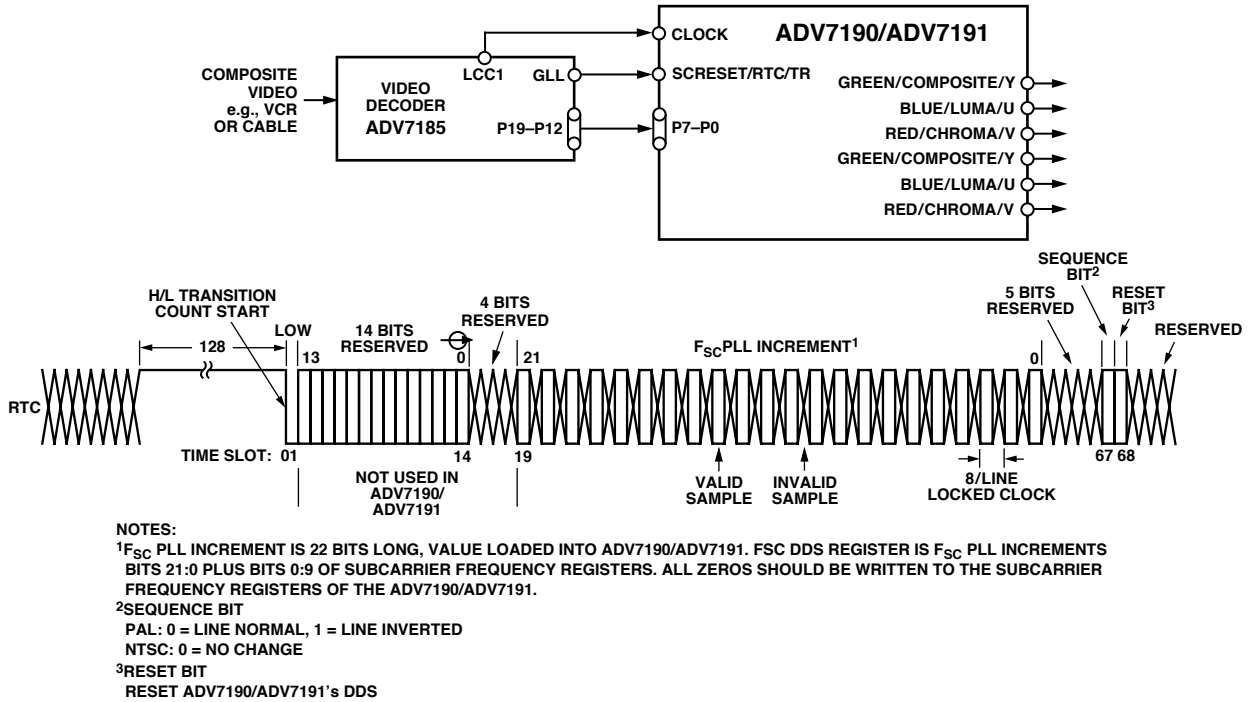

Figure 32. RTC Timing and Connections

### Mode 0 (CCIR-656): Slave Option

(Timing Register 0 TR0 = X X X X X 0 0 0)

The ADV7190/ADV7191 is controlled by the SAV (Start Active Video) and EAV (End Active Video) Time Codes in the Pixel Data. All timing information is transmitted using a 4-byte synchronization pattern. A synchronization pattern is sent immediately before and after each line during active picture and retrace. Mode 0 is illustrated in Figure 33. The  $\overline{\text{HSYNC}}$ ,  $\overline{\text{VSYNC}}$  and  $\overline{\text{BLANK}}$  pins (if not used) should be tied high during this mode.

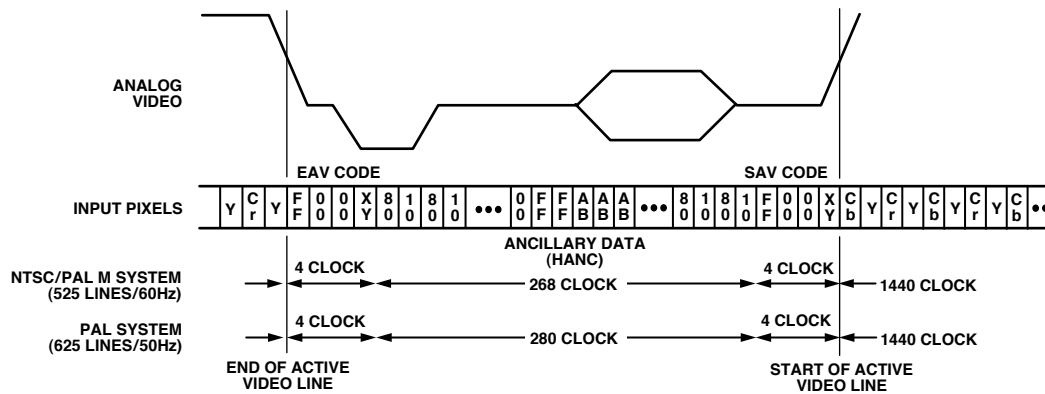

Figure 33. Timing Mode 0, Slave Mode

# ADV7190/ADV7191

## Mode 0 (CCIR-656): Master Option

(Timing Register 0 TR0 = X X X X X 0 0 1)

The ADV7190/ADV7191 generates H, V, and F signals required for the SAV and EAV Time Codes in the CCIR656 standard. The H bit is output on the  $\overline{\text{HSYNC}}$  pin, the V bit is output on the  $\overline{\text{BLANK}}$  pin and the F bit is output on the  $\overline{\text{VSYNC}}$  pin. Mode 0 is illustrated in Figure 34 (NTSC) and Figure 35 (PAL). The H, V, and F transitions relative to the video waveform are illustrated in Figure 36.

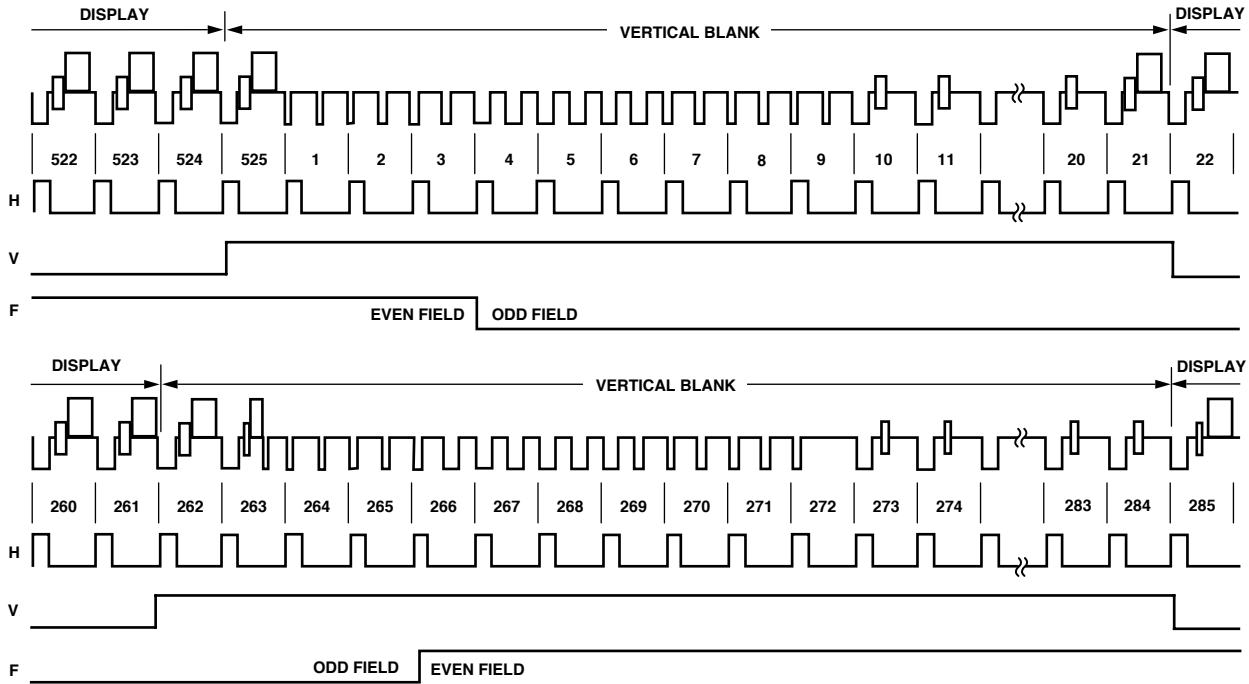

Figure 34. Timing Mode 0, NTSC Master Mode

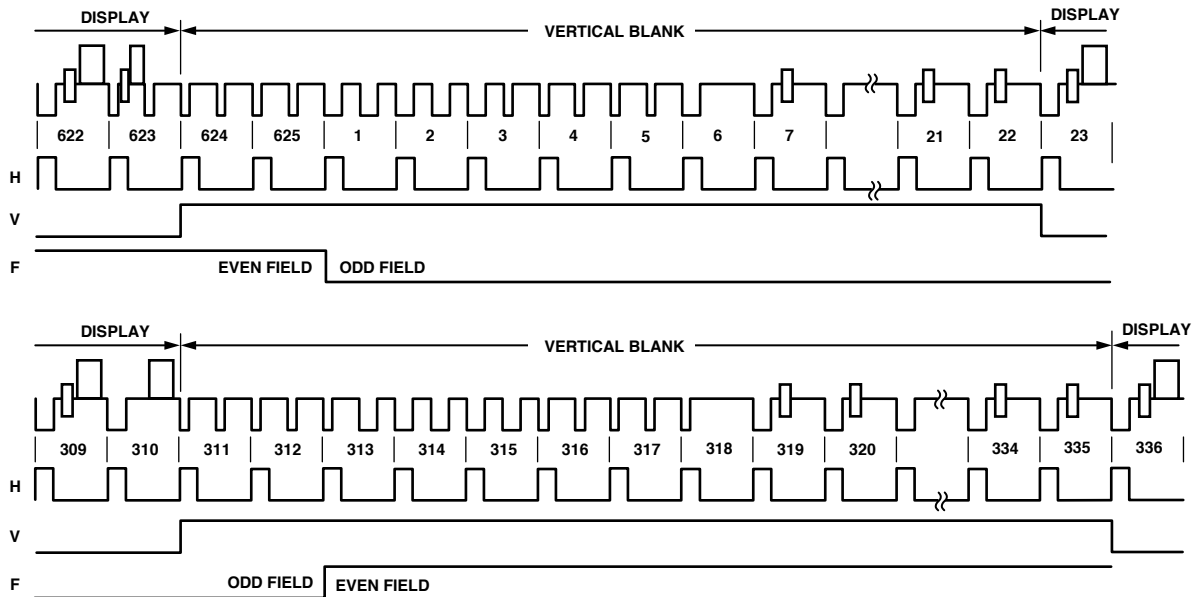

Figure 35. Timing Mode 0, PAL Master Mode

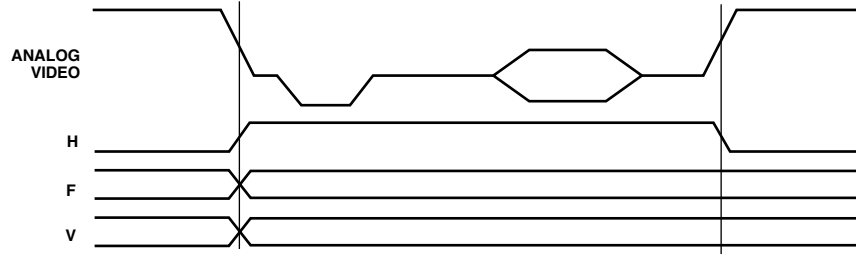

Figure 36. Timing Mode 0 Data Transitions, Master Mode

**Mode 1: Slave Option  $\overline{\text{HSYNC}}$ ,  $\overline{\text{BLANK}}$ , FIELD**  
 (Timing Register 0 TR0 = X X X X X 0 1 0)

In this mode the ADV7190/ADV7191 accepts Horizontal SYNC and Odd/ Even FIELD signals. A transition of the FIELD input when  $\overline{\text{HSYNC}}$  is low indicates a new frame, i.e., Vertical Retrace. The  $\overline{\text{BLANK}}$  signal is optional. When the  $\overline{\text{BLANK}}$  input is disabled the ADV7190/ADV7191 automatically blanks all normally blank lines as per CCIR-624. Mode 1 is illustrated in Figure 37 (NTSC) and Figure 38 (PAL).

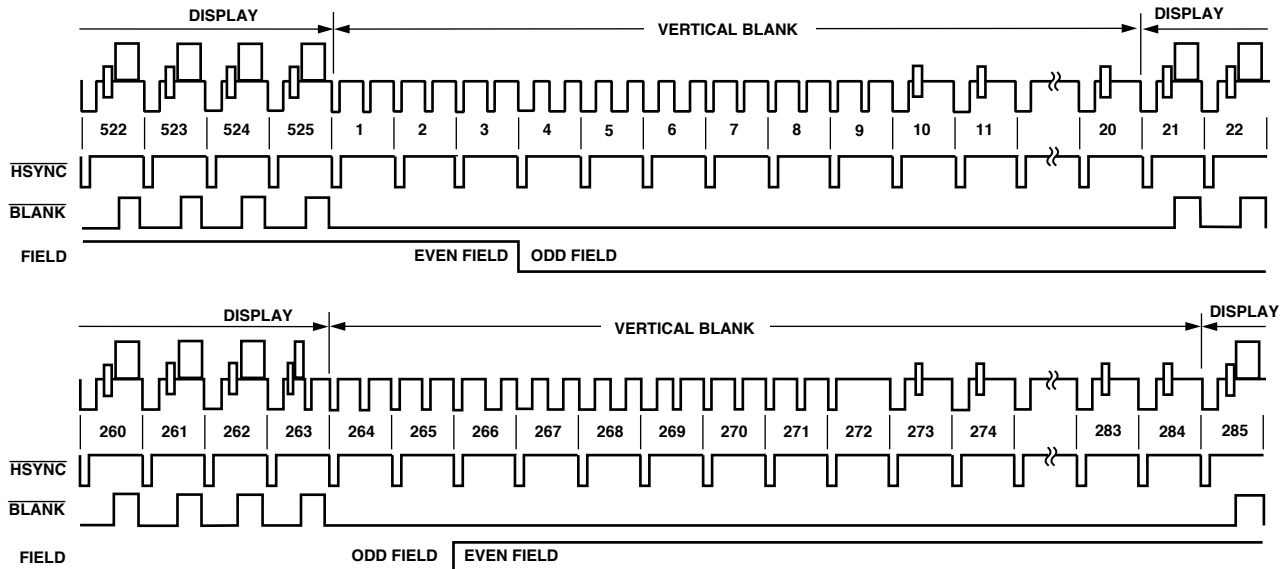

Figure 37. Timing Mode 1, NTSC

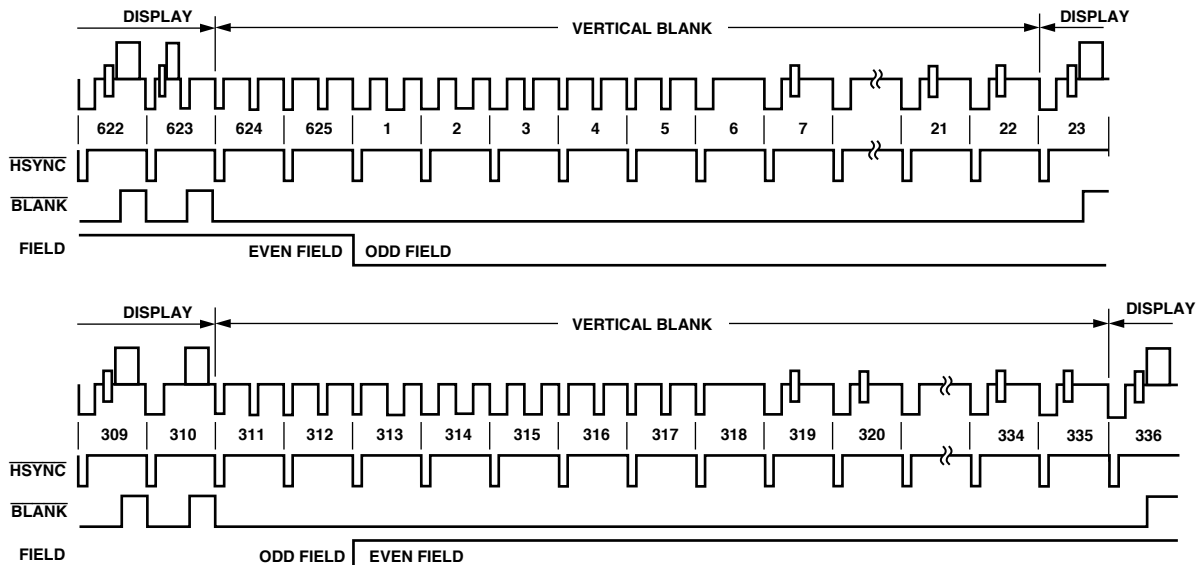

Figure 38. Timing Mode 1, PAL

# ADV7190/ADV7191

## Mode 1: Master Option $\overline{\text{HSYNC}}$ , $\overline{\text{BLANK}}$ , $\overline{\text{FIELD}}$

(Timing Register 0 TR0 = X X X X X 0 1 1)

In this mode the ADV7190/ADV7191 can generate Horizontal SYNC and Odd/Even FIELD signals. A transition of the  $\overline{\text{FIELD}}$  input when  $\overline{\text{HSYNC}}$  is low indicates a new frame, i.e., Vertical Retrace. The  $\overline{\text{BLANK}}$  signal is optional. When the  $\overline{\text{BLANK}}$  input is disabled the ADV7190/ADV7191 automatically blanks all normally blank lines as per CCIR-624. Pixel data is latched on the rising clock edge following the timing signal transitions. Mode 1 is illustrated in Figure 37 (NTSC) and Figure 38 (PAL). Figure 39 illustrates the  $\overline{\text{HSYNC}}$ ,  $\overline{\text{BLANK}}$  and  $\overline{\text{FIELD}}$  for an odd or even field transition relative to the pixel data.

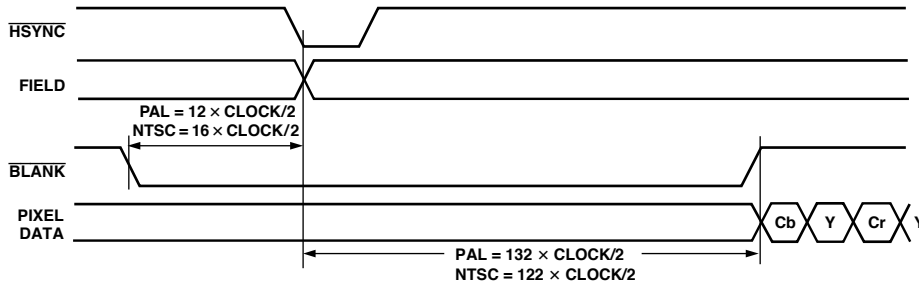

Figure 39. Timing Mode 1, Odd/Even Field Transitions Master/Slave

## Mode 2: Slave Option $\overline{\text{HSYNC}}$ , $\overline{\text{VSYNC}}$ , $\overline{\text{BLANK}}$

(Timing Register 0 TR0 = X X X X X 1 0 0)

In this mode the ADV7190/ADV7191 accepts Horizontal and Vertical SYNC signals. A coincident low transition of both  $\overline{\text{HSYNC}}$  and  $\overline{\text{VSYNC}}$  inputs indicates the start of an Odd Field. A  $\overline{\text{VSYNC}}$  low transition when  $\overline{\text{HSYNC}}$  is high indicates the start of an Even Field. The  $\overline{\text{BLANK}}$  signal is optional. When the  $\overline{\text{BLANK}}$  input is disabled, the ADV7190/ADV7191 automatically blanks all normally blank lines as per CCIR-624. Mode 2 is illustrated in Figure 40 (NTSC) and Figure 41 (PAL).

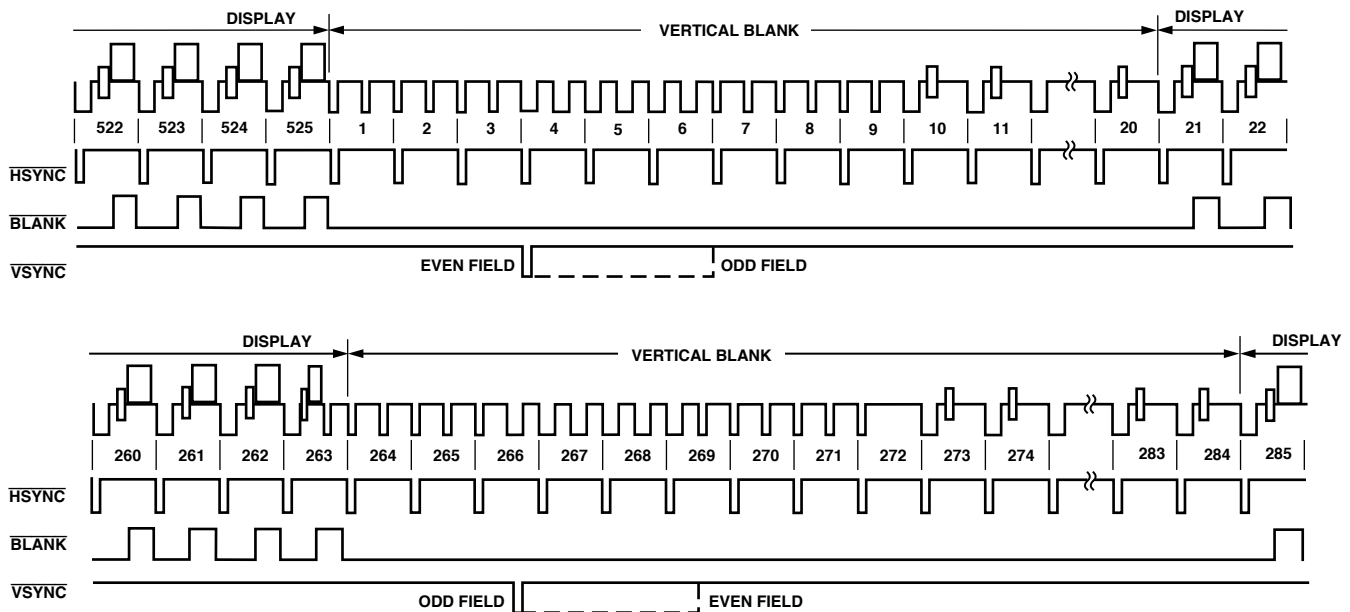

Figure 40. Timing Mode 2, NTSC



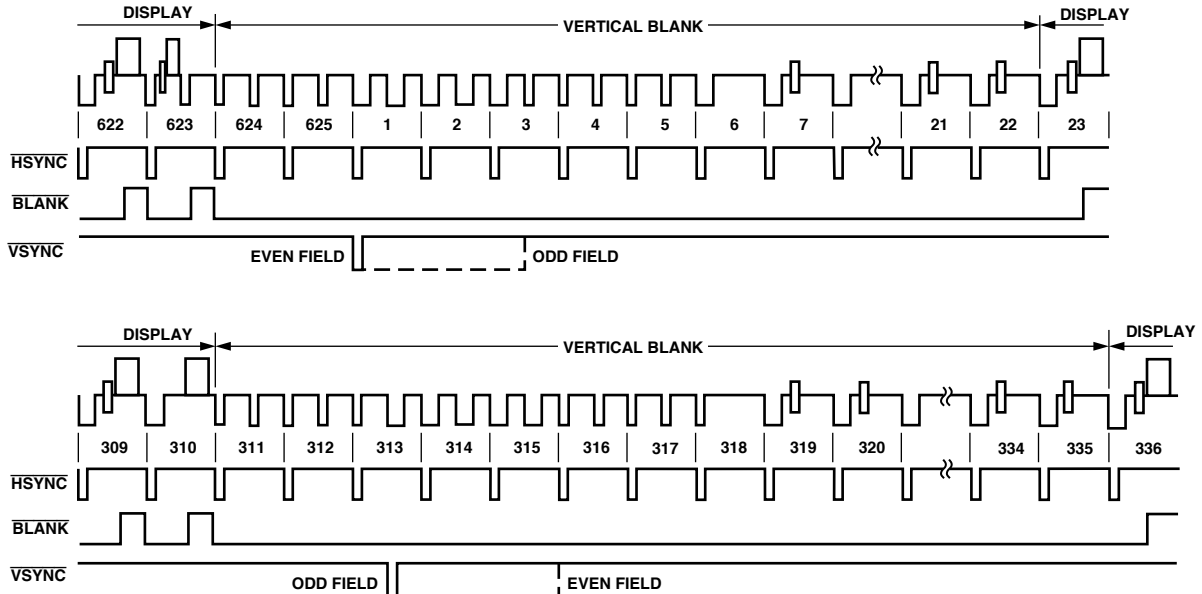

Figure 41. Timing Mode 2, PAL

**Mode 2: Master Option  $\overline{\text{HSYNC}}$ ,  $\overline{\text{VSYNC}}$ ,  $\overline{\text{BLANK}}$**

(Timing Register 0 TR0 = X X X X X 1 0 1)

In this mode the ADV7190/ADV7191 can generate Horizontal and Vertical SYNC signals. A coincident low transition of both  $\overline{\text{HSYNC}}$  and  $\overline{\text{VSYNC}}$  inputs indicates the start of an Odd Field. A  $\overline{\text{VSYNC}}$  low transition when  $\overline{\text{HSYNC}}$  is high indicates the start of an Even Field. The  $\overline{\text{BLANK}}$  signal is optional. When the  $\overline{\text{BLANK}}$  input is disabled the ADV7190/ADV7191 automatically blanks all normally blank lines as per CCIR-624. Mode 2 is illustrated in Figure 40 (NTSC) and Figure 41 (PAL). Figure 42 illustrates the  $\overline{\text{HSYNC}}$ ,  $\overline{\text{BLANK}}$  and  $\overline{\text{VSYNC}}$  for an even-to-odd field transition relative to the pixel data. Figure 43 illustrates the  $\overline{\text{HSYNC}}$ ,  $\overline{\text{BLANK}}$  and  $\overline{\text{VSYNC}}$  for an odd-to-even field transition relative to the pixel data.

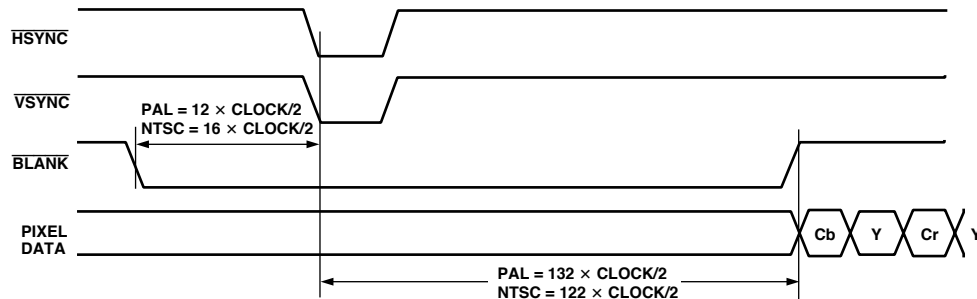

Figure 42. Timing Mode 2, Even-to-Odd Field Transition Master/Slave

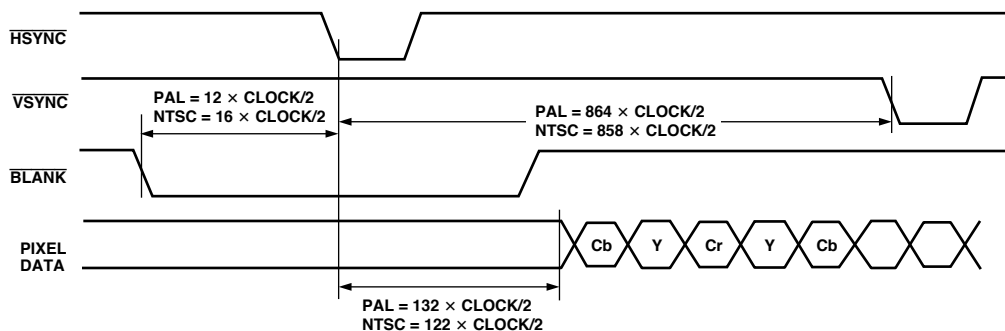

Figure 43. Timing Mode 2, Odd-to-Even Field Transition Master/Slave

# ADV7190/ADV7191

## Mode 3: Master/Slave Option $\overline{\text{HSYNC}}$ , $\overline{\text{BLANK}}$ , FIELD

(Timing Register 0 TR0 = X X X X X 1 1 0 or X X X X X 1 1 1)

In this mode the ADV7190/ADV7191 accepts or generates Horizontal SYNC and Odd/Even FIELD signals. A transition of the FIELD input when  $\overline{\text{HSYNC}}$  is high indicates a new frame, i.e., Vertical Retrace. The  $\overline{\text{BLANK}}$  signal is optional. When the  $\overline{\text{BLANK}}$  input is disabled the ADV7190/ADV7191 automatically blanks all normally blank lines as per CCIR-624. Mode 3 is illustrated in Figure 44 (NTSC) and Figure 45 (PAL).

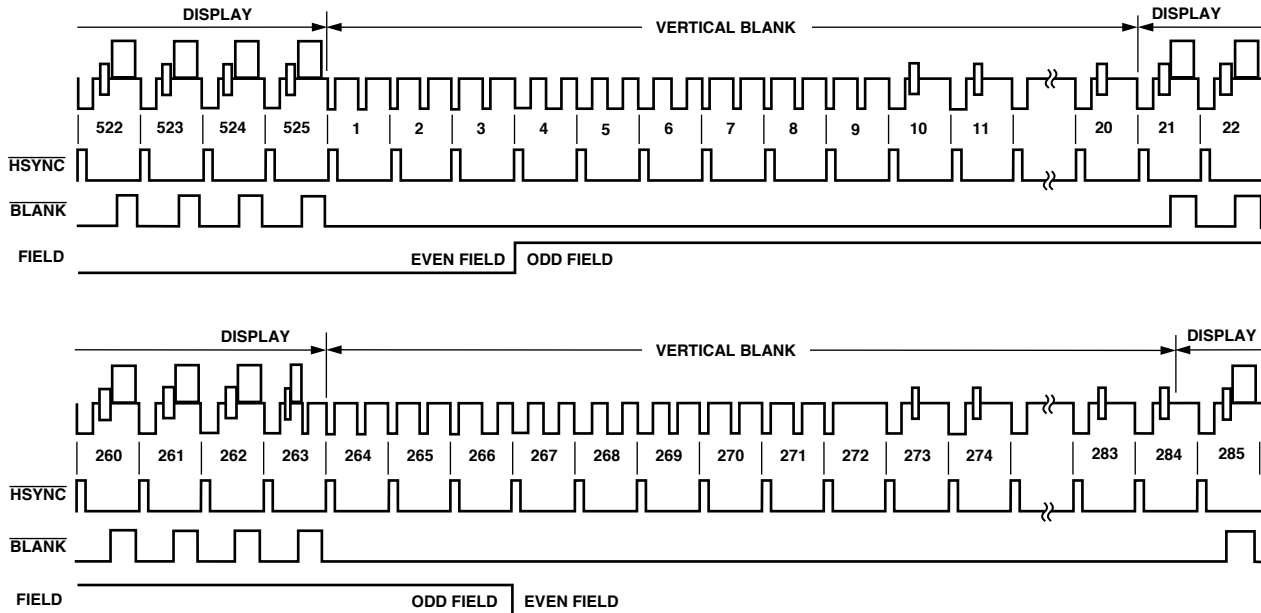

Figure 44. Timing Mode 3, NTSC

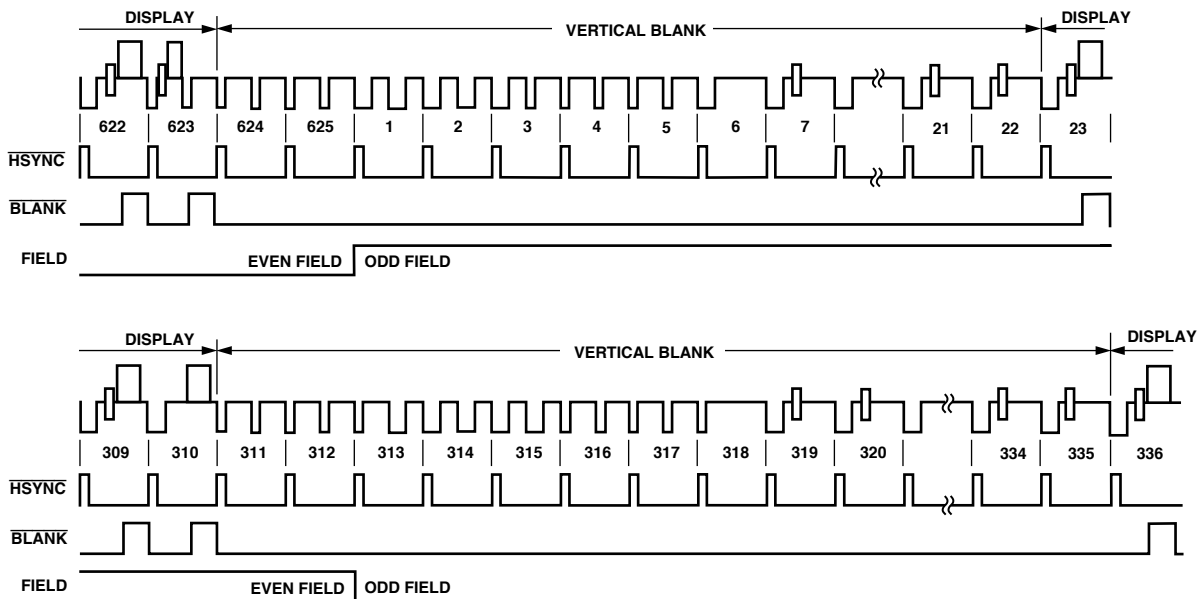

Figure 45. Timing Mode 3, PAL

## MPU PORT DESCRIPTION

The ADV7190/ADV7191 supports a two-wire serial (I<sup>2</sup>C-compatible) microprocessor bus driving multiple peripherals. Two inputs, Serial Data (SDA) and Serial Clock (SCL), carry information between any device connected to the bus. Each slave device is recognized by a unique address. The ADV7190/ADV7191 has four possible slave addresses for both read and write operations. These are unique addresses for each device and are illustrated in Figure 46 and Figure 47. The LSB sets either a read or write operation. Logic Level 1 corresponds to a read operation while Logic Level 0 corresponds to a write operation. A1 is set by setting the ALSB pin of the ADV7190/ADV7191 to Logic Level 0 or Logic Level 1.

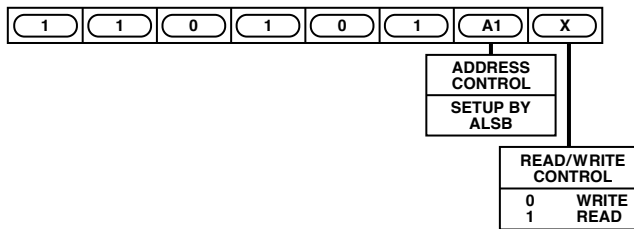

Figure 46a. Slave Address for ADV7190

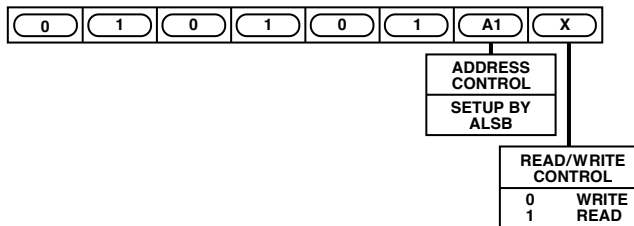

Figure 46b. Slave Address for ADV7191

To control the various devices on the bus the following protocol must be followed. First, the master initiates a data transfer by establishing a start condition, defined by a high-to-low transition on SDA while SCL remains high. This indicates that an address/data stream will follow. All peripherals respond to the start condition and shift the next eight bits (7-bit address + R/W bit). The bits are transferred from MSB down to LSB. The peripheral that recognizes the transmitted address responds by pulling the data line low during the ninth clock pulse. This is known as an acknowledge bit. All other devices withdraw from the bus at this point and maintain an idle condition. The idle condition is where the device monitors the SDA and SCL lines waiting for the start condition and the correct transmitted address. The R/W bit determines the direction of the data.

A Logic 0 on the LSB of the first byte means that the master will write information to the peripheral. A Logic 1 on the LSB of the first byte means that the master will read information from the peripheral.

The ADV7190/ADV7191 acts as a standard slave device on the bus. The data on the SDA pin is eight bits long supporting the 7-bit addresses plus the R/W bit. It interprets the first byte as the device address and the second byte as the starting subaddress. The subaddresses autoincrement allowing data to be written to or read from the starting subaddress. A data transfer is always terminated by a stop condition. The user can also access any unique subaddress register on a one-by-one basis without having to update all the registers. There is one exception. The Subcarrier Frequency Registers should be updated in sequence, starting with Subcarrier Frequency Register 0. The autoincrement function should be then used to increment and access Subcarrier Frequency Registers 1, 2, and 3. The Subcarrier Frequency Registers should not be accessed independently.

Stop and start conditions can be detected at any stage during the data transfer. If these conditions are asserted out of sequence with normal read and write operations, they cause an immediate jump to the idle condition. During a given SCL high period the user should issue only one start condition, one stop condition, or a single stop condition followed by a single start condition. If, an invalid subaddress is issued by the user, the ADV7190/ADV7191 will not issue an acknowledge and will return to the idle condition. If in autoincrement mode, the user exceeds the highest subaddress, the following action will be taken:

1. In Read Mode, the highest subaddress register contents will continue to be output until the master device issues a no-acknowledge. This indicates the end of a read. A no-acknowledge condition is where the SDA line is not pulled low on the ninth pulse.
2. In Write Mode, the data for the invalid byte will be not be loaded into any subaddress register, a no-acknowledge will be issued by the ADV7190/ADV7191 and the part will return to the idle condition.

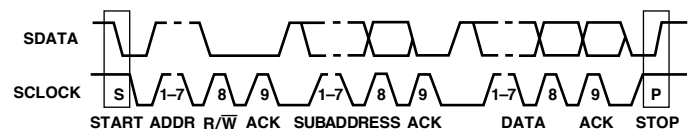

Figure 47. Bus Data Transfer

Figure 47 illustrates an example of data transfer for a read sequence and the start and stop conditions.

Figure 48 shows bus write and read sequences.

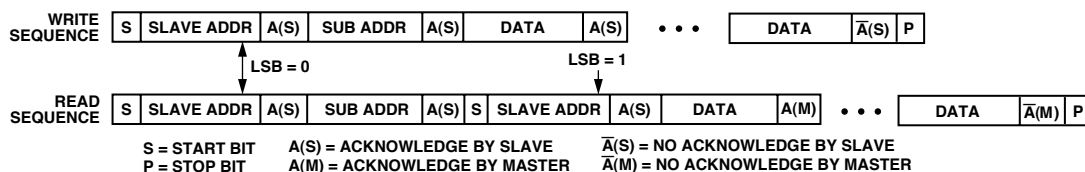

Figure 48. Write and Read Sequences

# ADV7190/ADV7191

## REGISTER ACCESSES

The MPU can write to or read from all of the registers of the ADV7190/ADV7191 with the exception of the Subaddress Registers, which are write-only registers. The Subaddress Register determines which register the next read or write operation accesses. All communications with the part through the bus start with an access to the Subaddress Register. Then a read/write operation is performed from/to the target address which then increments to the next address until a stop command on the bus is performed.

## REGISTER PROGRAMMING

The following section describes each register. All registers can be read from as well as written to.

## Subaddress Register (SR7–SR0)

The Communications Register is an eight bit write-only register. After the part has been accessed over the bus and a read/write operation is selected, the subaddress is set up. The Subaddress Register determines to/from which register the operation takes place.

Figure 49 shows the various operations under the control of the Subaddress Register 0 should always be written to SR7.

## Register Select (SR6–SR0)

These bits are set up to point to the required starting address.

ADV7190/ADV7191 SUBADDRESS REGISTER								
SR7	SR6	SR5	SR4	SR3	SR2	SR1	SR0	
ADV7190/ADV7191 SUBADDRESS REGISTER								
ADDRESS	SR6	SR5	SR4	SR3	SR2	SR1	SR0	
00H	0	0	0	0	0	0	0	MODE REGISTER 0
01H	0	0	0	0	0	0	1	MODE REGISTER 1
02H	0	0	0	0	0	1	0	MODE REGISTER 2
03H	0	0	0	0	0	1	1	MODE REGISTER 3
04H	0	0	0	0	1	0	0	MODE REGISTER 4
05H	0	0	0	0	1	0	1	MODE REGISTER 5
06H	0	0	0	0	1	1	0	MODE REGISTER 6
07H	0	0	0	0	1	1	1	MODE REGISTER 7
08H	0	0	0	1	0	0	0	MODE REGISTER 8
09H	0	0	0	1	0	0	1	MODE REGISTER 9
0AH	0	0	0	1	0	1	0	TIMING REGISTER 0
0BH	0	0	0	1	0	1	1	TIMING REGISTER 1
0CH	0	0	0	1	1	0	0	SUBCARRIER FREQUENCY REGISTER 0
0DH	0	0	0	1	1	0	1	SUBCARRIER FREQUENCY REGISTER 1
0EH	0	0	0	1	1	1	0	SUBCARRIER FREQUENCY REGISTER 2
0FH	0	0	0	1	1	1	1	SUBCARRIER FREQUENCY REGISTER 3
10H	0	0	1	0	0	0	0	SUBCARRIER PHASE REGISTER
11H	0	0	1	0	0	0	1	CLOSED CAPTIONING EXTENDED DATA BYTE 0
12H	0	0	1	0	0	1	0	CLOSED CAPTIONING EXTENDED DATA BYTE 1
13H	0	0	1	0	0	1	1	CLOSED CAPTIONING DATA BYTE 0
14H	0	0	1	0	1	0	0	CLOSED CAPTIONING DATA BYTE 1
15H	0	0	1	0	1	0	1	NTSC PEDESTAL/TELETEXT CONTROL REGISTER 0
16H	0	0	1	0	1	1	0	NTSC PEDESTAL/TELETEXT CONTROL REGISTER 1
17H	0	0	1	0	1	1	1	NTSC PEDESTAL/TELETEXT CONTROL REGISTER 2
18H	0	0	1	1	0	0	0	NTSC PEDESTAL/TELETEXT CONTROL REGISTER 3
19H	0	0	1	1	0	0	1	CGMS/WSS 0
1AH	0	0	1	1	0	1	0	CGMS/WSS 1
1BH	0	0	1	1	0	1	1	CGMS/WSS 2
1CH	0	0	1	1	1	0	0	TELETEXT REQUEST CONTROL REGISTER
1DH	0	0	1	1	1	0	1	CONTRAST CONTROL REGISTER
1EH	0	0	1	1	1	1	0	U SCALE
1FH	0	0	1	1	1	1	1	V SCALE
20H	0	1	0	0	0	0	0	HUE ADJUST CONTROL REGISTER
21H	0	1	0	0	0	0	1	BRIGHTNESS CONTROL REGISTER
22H	0	1	0	0	0	1	0	SHARPNESS CONTROL REGISTER
23H	0	1	0	0	0	1	1	DNR 0
24H	0	1	0	0	1	0	0	DNR 1
25H	0	1	0	0	1	0	1	DNR 2
26H	0	1	0	0	1	1	0	GAMMA CORRECTION REGISTER 0
27H	0	1	0	0	1	1	1	GAMMA CORRECTION REGISTER 1
28H	0	1	0	1	0	0	0	GAMMA CORRECTION REGISTER 2
29H	0	1	0	1	0	0	1	GAMMA CORRECTION REGISTER 3
2AH	0	1	0	1	0	1	0	GAMMA CORRECTION REGISTER 4
2BH	0	1	0	1	0	1	1	GAMMA CORRECTION REGISTER 5
2CH	0	1	0	1	1	0	0	GAMMA CORRECTION REGISTER 6
2DH	0	1	0	1	1	0	1	GAMMA CORRECTION REGISTER 7
2EH	0	1	0	1	1	1	0	GAMMA CORRECTION REGISTER 8
2FH	0	1	0	1	1	1	1	GAMMA CORRECTION REGISTER 9
30H	0	1	1	0	0	0	0	GAMMA CORRECTION REGISTER 10
31H	0	1	1	0	0	0	1	GAMMA CORRECTION REGISTER 11
32H	0	1	1	0	0	1	0	GAMMA CORRECTION REGISTER 12
33H	0	1	1	0	0	1	1	GAMMA CORRECTION REGISTER 13
34H	0	1	1	0	1	0	0	BRIGHTNESS DETECT REGISTER
35H	0	1	1	0	1	0	1	OUTPUT CLOCK REGISTER
36H	0	1	1	0	1	1	0	RESERVED
37H	0	1	1	0	1	1	1	RESERVED
38H	0	1	1	1	0	0	0	RESERVED
39H	0	1	1	1	0	0	1	RESERVED
3AH	0	1	1	1	0	1	0	MACROVISION REGISTER (ADV7190 ONLY)
3BH	0	1	1	1	0	1	1	MACROVISION REGISTER (ADV7190 ONLY)
3CH	0	1	1	1	1	0	0	MACROVISION REGISTER (ADV7190 ONLY)
3DH	0	1	1	1	1	0	1	MACROVISION REGISTER (ADV7190 ONLY)
3EH	0	1	1	1	1	1	0	MACROVISION REGISTER (ADV7190 ONLY)
3FH	1	1	1	1	1	1	1	MACROVISION REGISTER (ADV7190 ONLY)
40H	1	0	0	0	0	0	0	MACROVISION REGISTER (ADV7190 ONLY)
41H	1	0	0	0	0	0	1	MACROVISION REGISTER (ADV7190 ONLY)
42H	1	0	0	0	0	1	0	MACROVISION REGISTER (ADV7190 ONLY)
43H	1	0	0	0	0	1	1	MACROVISION REGISTER (ADV7190 ONLY)
44H	1	0	0	0	1	0	0	MACROVISION REGISTER (ADV7190 ONLY)
45H	1	0	0	0	1	0	1	MACROVISION REGISTER (ADV7190 ONLY)
46H	1	0	0	0	1	1	0	MACROVISION REGISTER (ADV7190 ONLY)
47H	1	0	0	1	1	1	1	MACROVISION REGISTER (ADV7190 ONLY)
48H	1	0	0	1	0	1	0	MACROVISION REGISTER (ADV7190 ONLY)
49H	1	0	0	1	0	0	1	MACROVISION REGISTER (ADV7190 ONLY)
4AH	1	0	0	1	0	0	0	MACROVISION REGISTER (ADV7190 ONLY)
4BH	1	0	0	1	0	1	1	MACROVISION REGISTER (ADV7190 ONLY)

Figure 49. Subaddress Register

## MODE REGISTER 0

### MR0 (MR07–MR00)

(Address (SR4–SR0) = 00H)

Figure 50 shows the various operations under the control of Mode Register 0.

### MR0 BIT DESCRIPTION

#### Output Video Standard Selection (MR00–MR01)

These bits are used to set up the encoder mode. The ADV7190/ADV7191 can be set up to output NTSC, PAL (B, D, G, H, I), PAL M or PAL N standard video.

#### Luminance Filter Select (MR02–MR04)

These bits specify which luma filter is to be selected. The filter selection is made independent of whether PAL or NTSC is selected.

#### Chrominance Filter Select (MR05–MR07)

These bits select the chrominance filter. A low-pass filter can be selected with a choice of cut-off frequencies (0.65 MHz, 1.0 MHz, 1.3 MHz, 2 MHz, or 3 MHz) along with a choice of CIF or QCIF filters.

## MODE REGISTER 1

### MR1 (MR17–MR10)

(Address (SR4–SR0) = 01H)

Figure 51 shows the various operations under the control of Mode Register 1.

### MR1 BIT DESCRIPTION

#### DAC Control (MR10–MR15)

Bits MR15–MR10 can be used to power down the DACs. This is used to reduce the power consumption of the ADV7190/ADV7191 or if any of the DACs are not required in the application.

#### 4× Oversampling Control (MR16)

To enable 4× Oversampling this bit has to be set to 1. When enabled, the data is output at a frequency of 54 MHz.

Note that PLL Enable Control has to be enabled (MR61 = 0) in 4× Oversampling mode.

#### Reserved (MR17)

A Logical 0 must be written to this bit.

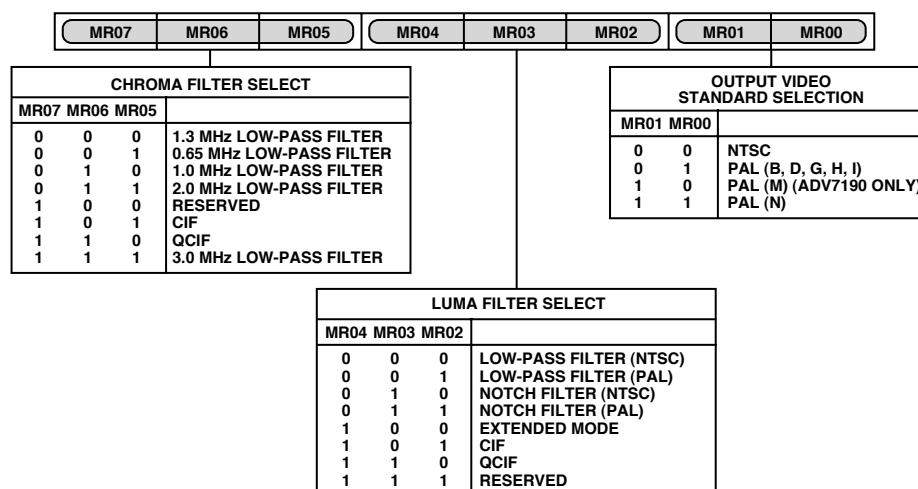

Figure 50. Mode Register 0 (MR0)

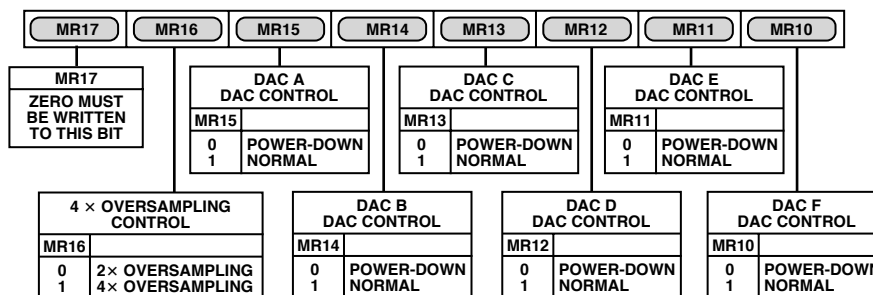

Figure 51. Mode Register 1 (MR1)

# ADV7190/ADV7191

## MODE REGISTER 2

### MR2 (MR27–MR20)

(Address (SR4–SR0) = 02H)

Mode Register 2 is an 8-bit-wide register.

Figure 52 shows the various operations under the control of Mode Register.

### MR2 BIT DESCRIPTION— RGB/YUV Control (MR20)

This bit enables the output from the small or large DACs to be set to YUV or RGB output video standard.

### DAC Output Control (MR21)

This bit controls the output from DACs A, B, and C. When this bit is set to 1, Composite, Luma, and Chroma Signals are output from DACs A, B, and C (respectively). When this bit is set to 0, RGB or YUV may be output from these DACs.

### SCART Enable Control (MR22)

This bit is used to switch the DAC outputs from SCART to a EUROSCART configuration. A complete table of all DAC output configurations is shown in Table III.

### Pedestal Control (MR23)

This bit specifies whether a pedestal is to be generated on the NTSC composite video signal. This bit is invalid when the device is configured in PAL mode.

### Square Pixel Control (MR24)

This bit is used to set up square pixel mode. This is available in Slave Mode only. For NTSC, a 24.5454 MHz clock must be supplied. For PAL, a 29.5 MHz clock must be supplied. Square pixel operation is not available in 4× Oversampling mode.

### Standard I<sup>2</sup>C Control (MR25)

This bit controls the video standard used by the ADV7190/ADV7191. When this bit is set to 1 the video standard as programmed in Output Video Standard Selection (MR00, MR01). When MR25 is set to 0, the ADV7190/ADV7191 is forced into the standard selected by the NTSC\_PAL pin. When NTSC\_PAL is low the standard is NTSC, when the NTSC\_PAL pin is high, the standard is PAL.

### Pixel Data Valid Control (MR26)

After resetting the device, this bit has the value 0 and the pixel data input to the encoder is blanked such that a black screen is output from the DACs. The ADV7190/ADV7191 will be set to Master Mode timing. When this bit is set to 1 by the user (via the I<sup>2</sup>C), pixel data passes to the pins and the encoder reverts to the Timing Mode defined by Timing Register 0.

### Sleep Mode Control (MR27)

When this bit is set (1), Sleep Mode is enabled. With this mode enabled, the ADV7190/ADV7191 current consumption is reduced to less than 1 mA. The I<sup>2</sup>C registers can be written to and read from when the ADV7190/ADV7191 is in Sleep Mode.

When the device is in Sleep Mode and 0 is written to MR27, the ADV7190/ADV7191 will come out of Sleep Mode and resume normal operation. Also, if a  $\overline{\text{RESET}}$  is applied during Sleep Mode, the ADV7190/ADV7191 will come out of Sleep Mode and resume normal operation.

For this to operate, Power Up in Sleep Mode Control has to be enabled (MR60 = 0), otherwise Sleep Mode is controlled by the PAL\_NTSC and SCRESET/RTC/TR pins.

Table III. DAC Output Configuration Matrix

SCART MR22	DAC O/P MR21	RGB/YUV MR20	DAC A	DAC B	DAC C	DAC D	DAC E	DAC F
0	0	0	G	B	R	CVBS	LUMA	CHROMA
0	0	1	Y	U	V	CVBS	LUMA	CHROMA
0	1	0	CVBS	LUMA	CHROMA	G	B	R
0	1	1	CVBS	LUMA	CHROMA	Y	U	V
1	0	0	CVBS	B	R	G	LUMA	CHROMA
1	0	1	CVBS	U	V	Y	LUMA	CHROMA
1	1	0	CVBS	LUMA	CHROMA	G	B	R
1	1	1	CVBS	LUMA	CHROMA	Y	U	V

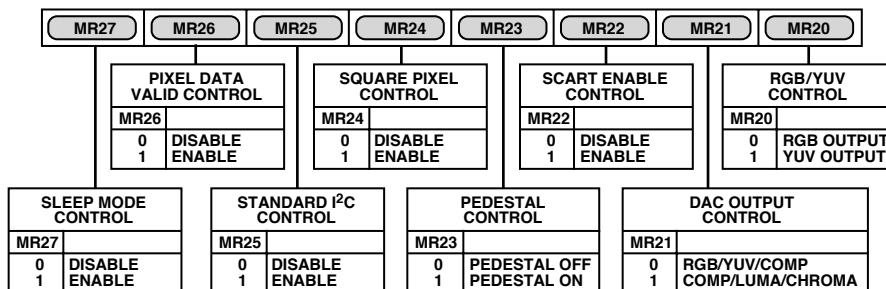

Figure 52. Mode Register 2 (MR2)



# ADV7190/ADV7191

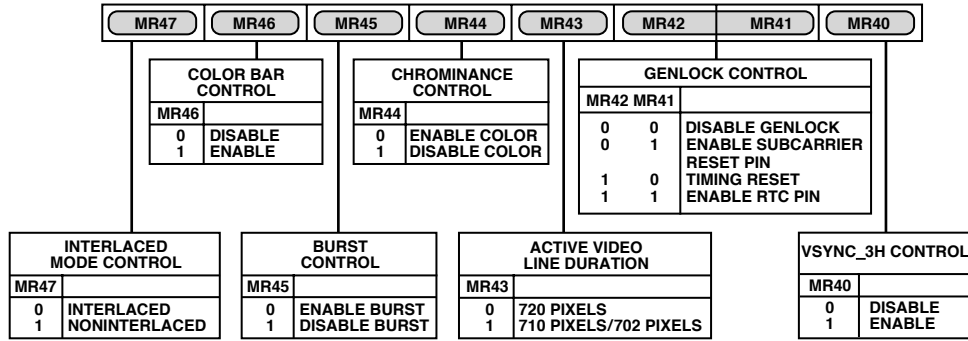

Figure 54. Mode Register 4 (MR4)

## Interlaced Mode Control (MR47)

This bit is used to setup the output to interlaced or noninterlaced mode.

## MODE REGISTER 5

### MR5 (MR57–MR50)

(Address (SR4–SR0) = 05H)

Mode Register 5 is an 8-bit-wide register. Figure 55 shows the various operations under the control of Mode Register 5.

## MR5 BIT DESCRIPTION

### Y-Level Control (MR50)

This bit controls the component Y output level on the ADV7190/ADV7191. If this bit is set (0), the encoder outputs Betacam levels when configured in PAL or NTSC mode. If this bit is set (1), the encoder outputs SMPTE levels when configured in PAL or NTSC mode.

### UV-Levels Control (MR51–MR52)

These bits control the component U and V output levels on the ADV7190/ADV7191. It is possible to have UV levels with a peak-to-peak amplitude of either 700 mV (MR52 + MR51 = 01) or 1000 mV (MR52 + MR51 = 10) in NTSC and PAL.

It is also possible to have default values of 934 mV for NTSC and 700 mV for PAL (MR52 + MR51 = 00).

### RGB Sync (MR53)

This bit is used to set up the RGB outputs with the sync information encoded on all RGB outputs.

### Clamp Delay Value (MR54–MR55)

These bits control the delay or advance of the CLAMP signal in the front or back porch of the ADV7190/ADV7191. It is possible to delay or advance the pulse by zero, one, two, or three clock cycles.

Note: Pin 51 is a multifunctional pin ( $\overline{\text{VSO}}/\text{CLAMP}$ ). CLAMP/ $\overline{\text{VSO}}$  Select Control (MR77) has to be set accordingly.

### Clamp Delay Direction (MR56)

This bit controls a positive or negative delay in the CLAMP signal. If this bit is set (1), the delay is negative. If it is set (0), the delay is positive.

### Clamp Position (MR57)

This bit controls the position of the CLAMP signal. If this bit is set (1), the CLAMP signal is located in the back porch position. If this bit is set (0), the CLAMP signal is located in the front porch position.

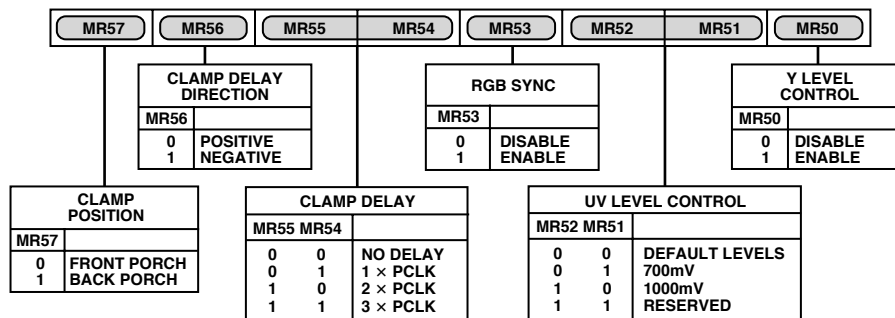

Figure 55. Mode Register 5 (MR5)



## MODE REGISTER 6

### MR6 (MR67–MR60)

(ADDRESS (SR4–SR0) = 06H)

Mode Register 6 is an 8-bit-wide register. Figure 56 shows the various operations under the control of Mode Register 6.

### MR6 BIT DESCRIPTION

#### Power-Up Sleep Mode Control (MR60)

After  $\overline{\text{RESET}}$  is applied this control is enabled (MR60 = 0) if both  $\overline{\text{SCRESET}}/\text{RTC}/\text{TR}$  and  $\text{NTSC\_PAL}$  pins are tied high. The ADV7190/ADV7191 will then power up in Sleep Mode to facilitate low power consumption while the I<sup>2</sup>C is initialized. When this control is disabled (MR60 = 1, via the I<sup>2</sup>C) Sleep Mode control passes to Sleep Mode Control, MR27.

#### PPL Enable Control (MR61)

The PLL control should be enabled (MR61 = 0) when 4× Oversampling is enabled (MR16 = 1). It is also used to reset the PLL when this bit is toggled.

#### Reserved (MR62, MR63, MR64)

A Logic 0 must be written to these bits.

#### Field Counter (MR65, MR66, MR67)

These three bits are read-only bits. The field count can be read back over the I<sup>2</sup>C interface. In NTSC mode the field count goes from 0–3, in PAL Mode from 0–7.

## MODE REGISTER 7

### MR7 (MR77–MR70)

(Address (SR4–SR0) = 07H)

Mode Register 7 is an 8-bit-wide register. Figure 57 shows the various operations under the control of Mode Register 7.

### MR7 BIT DESCRIPTION

#### Color Control Enable (MR70)

This bit is used to enable control of contrast and saturation of color. If this bit is set (1), color controls are enabled (Contrast Control Register, U-Scale Register, V-Scale Register). If this bit is set (0), the color control features are disabled.

#### Luma Saturation Control (MR71)

When this bit is set (1), the luma signal will be clipped if it reaches a limit that corresponds to an input luma value of 255 (after scaling by the Contrast Control Register). This prevents the chrominance component of the composite video signal being clipped if the amplitude of the luma is too high. When this bit is set (0), this control is disabled.

#### Hue Adjust Control (MR72)

This bit is used to enable hue adjustment on the composite and chroma output signals of the ADV7190/ADV7191. When this bit is set (1), the hue of the color is adjusted by the phase offset described in the Hue Adjust Control Register. When this bit is set (0), hue adjustment is disabled.

#### Brightness Enable Control (MR73)

This bit is used to enable the brightness control of the ADV7190/ADV7191. The actual brightness level is programmed in the Brightness Control Register. This value or “setup” level is added to the scaled Y data. When this bit is set (1), brightness control is enabled. When this bit is set (0), brightness control is disabled.

#### Sharpness Filter Enable (MR74)

This bit is used to enable the sharpness control of the luminance signal on the ADV7190/ADV7191 (Luma Filter Select has to be set to Extended, i.e., MR04–MR02 = 100). The various responses of the filter are determined by the Sharpness Control Register. When this bit is set (1), the luma response is altered by the amount described in the Sharpness Control Register. When this bit is set (0), the sharpness control is disabled. See Internal Filter Response section for luma signal responses.

#### CSO\_HSO Output Control (MR75)

This bit is used to determine whether  $\overline{\text{HSO}}$  or  $\overline{\text{CSO}}$  TTL output signal is output at the  $\overline{\text{CSO\_HSO}}$  pin. If this bit is set (1), the  $\overline{\text{CSO}}$  TTL signal is output. If this bit is set 0, the  $\overline{\text{HSO}}$  TTL signal is output.

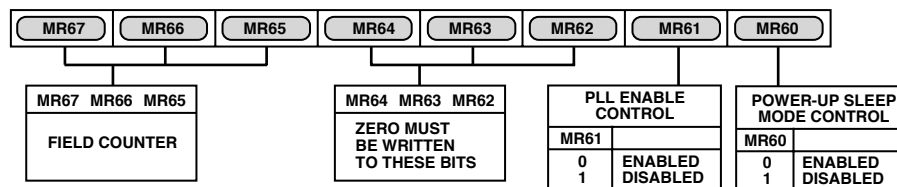

Figure 56. Mode Register 6 (MR6)

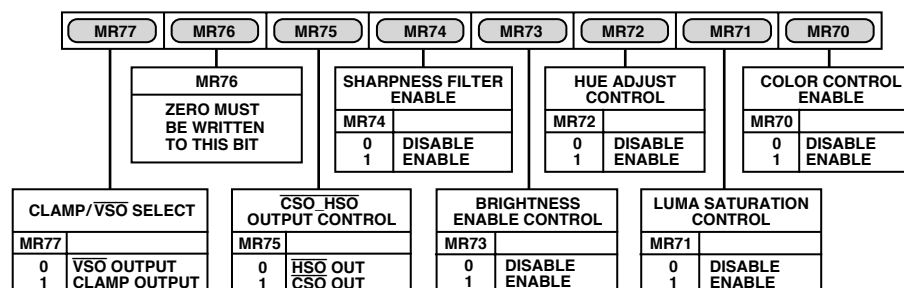

Figure 57. Mode Register 7 (MR7)

# ADV7190/ADV7191

## Reserved (MR76)

A Logic 0 must be written to this bit.

## CLAMP/ $\bar{V}SO$ Select (MR77)

This bit is used to select the functionality of Pin 51. A 1 selects CLAMP as the output signal. A 0 selects  $\bar{V}SO$  output.

## MODE REGISTER 8

### MR8 (MR87–MR80)

(Address (SR4–SR0) = 08H)

Mode Register 8 is an 8-bit-wide register. Figure 58 shows the various operations under the control of Mode Register 8.

## MR8 BIT DESCRIPTION

### Reserved (MR80, MR81)

A Logic 0 must be written to these bits.

### Double Buffer Control (MR82)

Double buffering can be enabled or disabled on the Contrast Control Register, U Scale Register, V Scale Register, Hue Adjust Control Register, Closed Captioning Register, Brightness Control Register, Gamma Curve Select Bit and the Macrovision Registers (ADV7190 only). Double Buffering is not available in Master Timing mode.

### 16-Bit Pixel Port (MR83)

This bit controls if the ADV7190/ADV7191 accepts 8-bit or 16-bit input data. In 8-bit mode the data will be input on Pins P0–P7. Unused pixel inputs should be grounded.

### Reserved (MR84)

A Logic 0 must be written to this bit.

### DNR Enable Control (MR85)

To enable the DNR process this bit has to be set to 1. If this bit is set to 0, the DNR processing is bypassed. For further information on DNR controls see DNR Registers 2–0, DNR1 Bit Description, and DNR2 Bit Description sections.

### Gamma Enable Control (MR86)

To enable the programmable gamma correction this bit has to be set to enabled (MR86 is set to 1). For further information

on Gamma Correction controls see Gamma Correction Registers 0–13 (Gamma 0–13) (Address (SR5–SR0) = 26H–32H) section.

### Gamma Curve Select Control (MR87)

This bit selects which of the two programmable gamma curves is used. When setting MR87 to 0, the gamma correction curve to be processed is Curve A. Otherwise, Curve B is selected. For further information on Gamma Correction controls see Gamma Correction Registers 0–13 (Gamma 0–13) (Address (SR5–SR0) = 26H–32H) section.

## MODE REGISTER 9

### MR9 (MR97–MR90)

(Address (SR4–SR0) = 09H)

Mode Register 9 is an 8-bit-wide register. Figure 59 shows the various operations under the control of Mode Register 9.

## MR9 BIT DESCRIPTION

### Undershoot Limiter (MR90–MR91)

This control ensures that no luma video data will go below a programmable level. This prevents any synchronization problems due to luma signals going below the blanking level. Available limit levels are –1.5 IRE, –6 IRE, –11 IRE.

Note that this facility is only available in 4× Oversampling mode (MR16 = 1). When the device is operated in 2× Oversampling mode (MR16 = 0) or RGB outputs without RGB sync are selected, the minimum luma level is set in Timing Register 0, TR06 (Min Luma Control).

### Reserved (MR92–MR93)

A Logic 0 must be written to these bits.

### Chroma Delay Control (MR94–MR95)

The Chroma Signal can be delayed by up to 296 ns (eight clock cycles at 27 MHz) using MR94–MR95. For further information see also Chroma/Luma Delay section.

### Reserved (MR96–MR97)

A Logic 0 must be written to these bits.

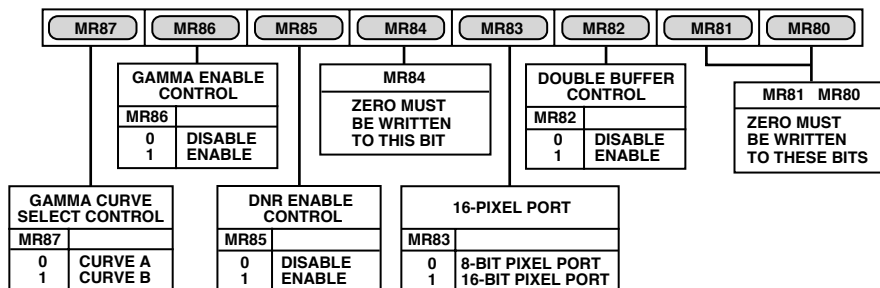

Figure 58. Mode Register 8 (MR8)

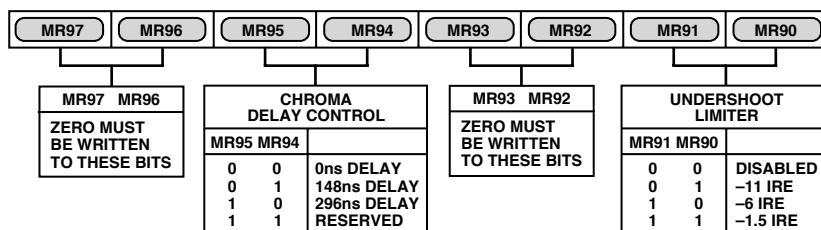

Figure 59. Mode Register 9 (MR9)

## TIMING REGISTER 0 (TR07–TR00)

(Address (SR4–SR0) = 0AH)

Figure 60 shows the various operations under the control of Timing Register 0. This register can be read from as well as written to.

### TR0 BIT DESCRIPTION

#### Master/Slave Control (TR00)

This bit controls whether the ADV7190/ADV7191 is in master or slave mode.

#### Timing Mode Selection (TR01–TR02)

These bits control the timing mode of the ADV7190/ADV7191. These modes are described in more detail in the Video Timing Description and  $\overline{\text{RESET}}$  Sequence sections of the data sheet.

#### BLANK Input Control (TR03)

This bit controls whether the  $\overline{\text{BLANK}}$  input is used to accept blank signals or whether blank signals are internally generated.

Note: When this input pin is tied high (to 5 V), the input is disabled regardless of the register setting. It, therefore, should be tied low (to Ground) to allow control over the I<sup>2</sup>C register.

#### Luma Delay (TR04–TR05)

The luma signal can be delayed by up to 222 ns (or six clock cycles at 27 MHz) using TR04–TR05. For further information see Chroma/Luma Delay section.

#### Min Luminance Value (TR06)

This bit is used to control the minimum luma output value by the ADV7190/ADV7191 in 2× Oversampling Mode (MR 16 = 0). When this bit is set to a Logic 1, the luma is limited to 7.5IRE below the blank level. When this bit is set to (0), the luma value can be as low as the sync bottom level (40IRE below blanking).

#### Timing Register Reset (TR07)

Toggling TR07 from low to high and low again resets the internal timing counters. This bit should be toggled after power-up, reset, or changing to a new timing mode.

## TIMING REGISTER 1

(TR17–TR10)

(Address (SR4–SR0) = 0BH)

Timing Register 1 is an 8-bit-wide register.

Figure 61 shows the various operations under the control of Timing Register 1. This register can be read from as well written to. This register can be used to adjust the width and position of the master mode timing signals.

### TR1 BIT DESCRIPTION

#### HSYNC Width (TR10–TR11)

These bits adjust the  $\overline{\text{HSYNC}}$  pulsewidth.

$T_{\text{PCLK}}$  = one clock cycle at 27 MHz.

#### HSYNC to VSYNC Delay Control (TR12–TR13)

These bits adjust the position of the  $\overline{\text{HSYNC}}$  output relative to the  $\overline{\text{VSYNC}}$  output.

$T_{\text{PCLK}}$  = one clock cycle at 27 MHz.

#### HSYNC to VSYNC Rising Edge Control (TR14–TR15)

When the ADV7190/ADV7191 is in Timing Mode 1, these bits adjust the position of the  $\overline{\text{HSYNC}}$  output relative to the  $\overline{\text{VSYNC}}$  output rising edge.

$T_{\text{PCLK}}$  = one clock cycle at 27 MHz.

#### VSYNC Width (TR14–TR15)

When the ADV7190/ADV7191 is configured in Timing Mode 2, these bits adjust the  $\overline{\text{VSYNC}}$  pulsewidth.

$T_{\text{PCLK}}$  = one clock cycle at 27 MHz.

#### HSYNC to Pixel Data Adjust (TR16–TR17)

This enables the  $\overline{\text{HSYNC}}$  to be adjusted with respect to the pixel data. This allows the Cr and Cb components to be swapped. This adjustment is available in both master and slave timing modes.

$T_{\text{PCLK}}$  = one clock cycle at 27 MHz.

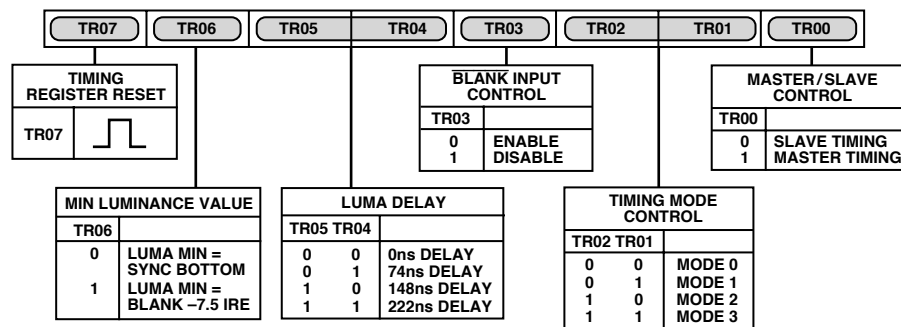

Figure 60. Timing Register 0

TR17		TR16		TR15		TR14		TR13		TR12		TR11		TR10	
HSYNC TO PIXEL DATA ADJUST				HSYNC TO VSYNC RISING EDGE DELAY (MODE 1 ONLY)				HSYNC TO VSYNC DELAY				HSYNC WIDTH			
TR17	TR16			TR15	TR14	$T_C$		TR13	TR12	$T_B$		TR11	TR10	$T_A$	
0	0	$0 \times T_{PCLK}$		x	0	$T_B$		0	0	$0 \times T_{PCLK}$		0	0	$1 \times T_{PCLK}$	
0	1	$1 \times T_{PCLK}$		x	1	$T_B + 32\mu s$		0	1	$4 \times T_{PCLK}$		0	1	$4 \times T_{PCLK}$	
1	0	$2 \times T_{PCLK}$						1	0	$8 \times T_{PCLK}$		1	0	$16 \times T_{PCLK}$	
1	1	$3 \times T_{PCLK}$						1	1	$18 \times T_{PCLK}$		1	1	$128 \times T_{PCLK}$	
				VSYNC WIDTH (MODE 2 ONLY)											
				TR15	TR14										
				0	0	$1 \times T_{PCLK}$									
				0	1	$4 \times T_{PCLK}$									
				1	0	$16 \times T_{PCLK}$									
				1	1	$128 \times T_{PCLK}$									

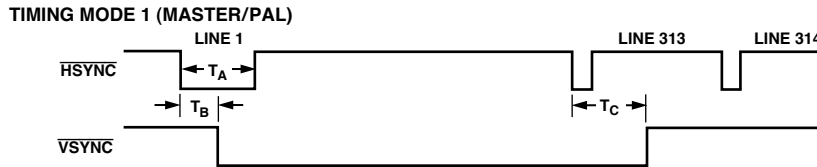

Figure 61. Timing Register 1

### SUBCARRIER FREQUENCY REGISTERS 3-0 (FSC31-FSC0) (Address (SR4-SR0) = 0CH-0FH)

These 8-bit-wide registers are used to set up the Subcarrier Frequency. The value of these registers are calculated by using the following equation:

$$\text{Subcarrier Frequency Register} = \frac{(2^{32} - 1) \times f_{SCF}}{f_{CLK}}$$

Example: NTSC Mode,  $f_{CLK} = 27 \text{ MHz}$ ,  $f_{SCF} = 3.5795454 \text{ MHz}$

$$\text{Subcarrier Frequency Value} = \frac{(2^{32} - 1) \times 3.5795454 \times 10^6}{27 \times 10^6}$$

Subcarrier Register Value = 21F07C16 Hex

Figure 62 shows how the frequency is set up by the four registers.

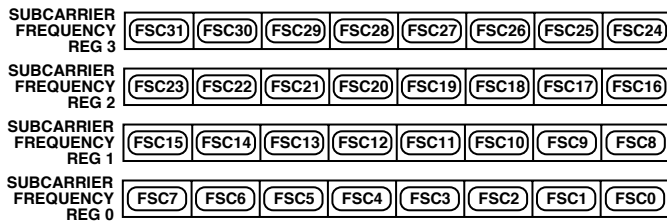

Figure 62. Subcarrier Frequency Registers

### SUBCARRIER PHASE REGISTER (FPH7-FPH0) (Address (SR4-SR0) = 10H)

This 8-bit-wide register is used to set up the Subcarrier Phase. Each bit represents 1.41°. For normal operation this register is set to 00Hex.



Figure 63. Subcarrier Phase Register

### CLOSED CAPTIONING EVEN FIELD DATA REGISTER 1-0 (CCD15-CCD0) (Address (SR4-SR0) = 11-12H)

These 8-bit-wide registers are used to set up the closed captioning extended data bytes on Even Fields. Figure 64 shows how the high and low bytes are set up in the registers.

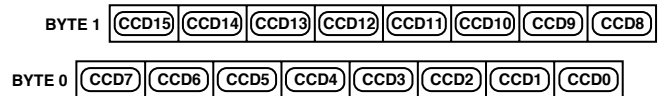

Figure 64. Closed Captioning Extended Data Register

### CLOSED CAPTIONING ODD FIELD DATA REGISTER 1-0 (CED15-CED0) (Subaddress (SR4-SR0) = 13-14H)

These 8-bit-wide registers are used to set up the closed captioning data bytes on Odd Fields. Figure 65 shows how the high and low bytes are set up in the registers.

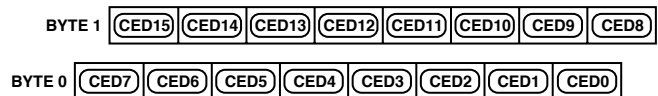

Figure 65. Closed Captioning Data Register

## NTSC PEDESTAL/PAL TELETEXT CONTROL REGISTERS 3-0

(PCE15-0, PCO15-0)/(TXE15-0, TXO15-0)  
(Subaddress (SR4-SR0) = 15-18H)

These 8-bit-wide registers are used to enable the NTSC pedestal/PAL Teletext on a line-by-line basis in the vertical blanking interval for both odd and even fields. Figures 66 and 67 show the four control registers. A Logic 1 in any of the bits of these registers has the effect of turning the Pedestal OFF on the equivalent line when used in NTSC. A Logic 1 in any of the bits of these registers has the effect of turning Teletext ON on the equivalent line when used in PAL.

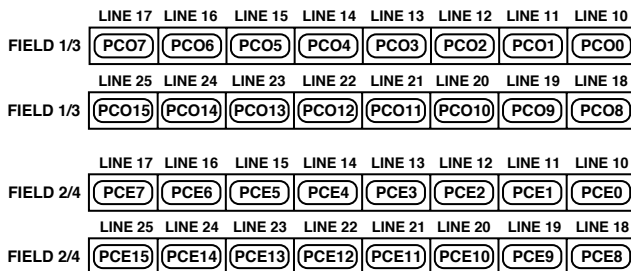

Figure 66. Pedestal Control Registers

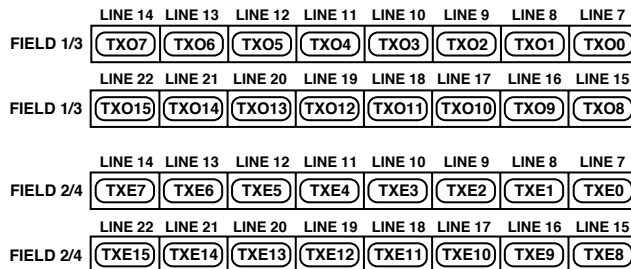

Figure 67. Teletext Control Registers

## TELETEXT REQUEST CONTROL REGISTER (TC07-TC00)

(Address (SR4-SR0) = 1CH)

Teletext Control Register is an 8-bit-wide register. See Figure 68.

### TTXREQ Falling Edge Control (TC00-TC03)

These bits control the position of the falling edge of TTXREQ. It can be programmed from zero clock cycles to a maximum of 15 clock cycles. This controls the active window for Teletext data. Increasing this value reduces the amount of Teletext bits below the default of 360. If Bits TC00-TC03 are 00Hex when

Bits TC07-TC04 are changed then the falling edge of TTXREQ will track that of the rising edge (i.e., the time between the falling and rising edge remains constant).

PCLK = clock cycle at 27 MHz.

### TTXREQ Rising Edge Control (TC04-TC07)

These bits control the position of the rising edge of TTXREQ. It can be programmed from zero clock cycles to a maximum of 15 clock cycles.

PCLK = clock cycle at 27 MHz.

TC07	TC06	TC05	TC04	TC03	TC02	TC01	TC00
TTXREQ RISING EDGE CONTROL				TTXREQ FALLING EDGE CONTROL			
TC07	TC06	TC05	TC04	TC03	TC02	TC01	TC00
0	0	0	0	0	PCLK	0	0
0	0	0	1	1	PCLK	0	1
"	"	"	"	"	PCLK	"	"
1	1	1	0	14	PCLK	1	1
1	1	1	1	15	PCLK	1	1

Figure 68. Teletext Control Register

## CGMS\_WSS REGISTER 0 C/W0 (C/W07-C/W00)

(Address (SR4-SR0) = 19H)

CGMS\_WSS register 0 is an 8-bit-wide register. Figure 69 shows the operations under control of this register.

### C/W0 BIT DESCRIPTION

#### CGMS Data (C/W00-C/W03)

These four data bits are the final four bits of CGMS data output stream. Note it is CGMS data ONLY in these bit positions, i.e., WSS data does not share this location.

#### CGMS CRC Check Control (C/W04)

When this bit is enabled (1), the last six bits of the CGMS data, i.e., the CRC check sequence, is internally calculated by the ADV7190/ADV7191. If this bit is disabled (0), the CRC values in the register are output to the CGMS data stream.

#### CGMS Odd Field Control (C/W05)

When this bit is set (1), CGMS is enabled for odd fields. Note this is only valid in NTSC mode.

#### CGMS Even Field Control (C/W06)

When this bit is set (1), CGMS is enabled for even fields. Note this is only valid in NTSC mode.

#### WSS Control (C/W07)

When this bit is set (1), wide screen signalling is enabled. Note this is only valid in PAL mode.

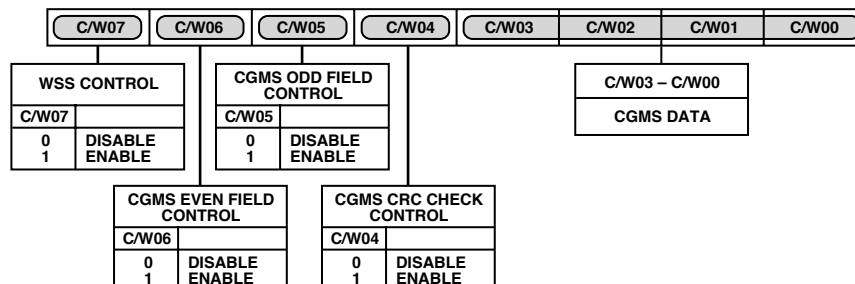

Figure 69. CGMS\_WSS Register 0

# ADV7190/ADV7191

## CGMS\_WSS REGISTER 1 C/W1 (C/W17–C/W10)

(Address (SR4–SR0) = 1AH)

CGMS\_WSS Register 1 is an 8-bit-wide register. Figure 70 shows the operations under control of this register.

### C/W1 BIT DESCRIPTION

#### CGMS/WSS Data (C/W10–C/W15)

These bit locations are shared by CGMS data and WSS data. In NTSC mode these bits are CGMS data. In PAL mode these bits are WSS data.

#### CGMS Data (C/W16–C/W17)

These bits are CGMS data bits only.

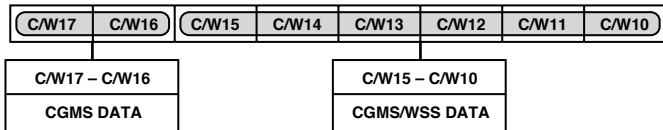

Figure 70. CGMS\_WSS Register 1

## CGMS\_WSS REGISTER 2

C/W1 (C/W27–C/W20)

(Address (SR4–SR0) = 1BH)

CGMS\_WSS Register 2 is an 8-bit-wide register. Figure 71 shows the operations under control of this register.

### C/W2 BIT DESCRIPTION

#### CGMS/WSS Data (C/W20–C/W27)

These bit locations are shared by CGMS data and WSS data. In NTSC mode these bits are CGMS data. In PAL mode these bits are WSS data.

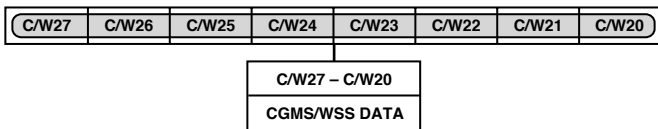

Figure 71. CGMS\_WSS Register 2

## CONTRAST CONTROL REGISTER (CC00–CC07)

(Address (SR4–SR0) = 1DH)

The contrast control register is an 8-bit-wide register used to scale the Y output levels. Figure 72 shows the operation under control of this register.

### Y Scale Value (CC00–CC07)

These eight bits represent the value required to scale the Y pixel data from 0.0 to 1.5 of its initial level. The value of these eight bits is calculated using the following equation:

$$Y \text{ Scale Value} = \text{Scale Factor} \times 128$$

Example:

Scale Factor = 1.18

Y Scale Value =  $1.18 \times 128 = 151.04$

Y Scale Value = 151 (rounded to the nearest integer)

Y Scale Value =  $10010111_b$

Y Scale Value =  $97_h$

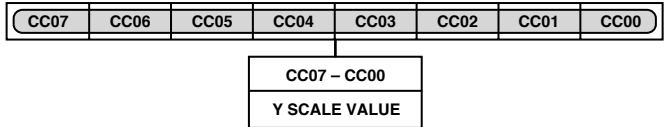

Figure 72. Contrast Control Register

## COLOR CONTROL REGISTERS 2–1 (CC2–CC1)

(Address (SR4–SR0) = 1EH–1FH)

The color control registers are 8-bit-wide registers used to scale the U and V output levels. Figure 73 shows the operations under control of these registers.

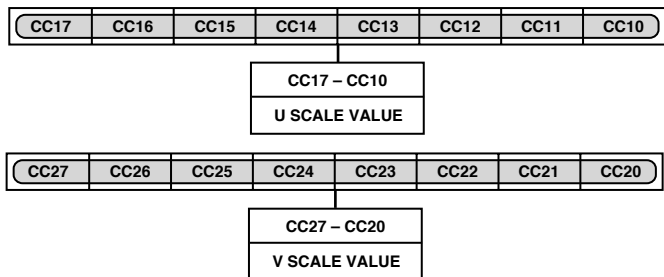

Figure 73. Color Control Registers

### CC1 BIT DESCRIPTION

#### U Scale Value (CC10–CC17)

These eight bits represent the value required to scale the U level from 0.0 to 2.0 of its initial level. The value of these eight bits is calculated using the following equation:

$$U \text{ Scale Value} = \text{Scale Factor} \times 128$$

Example:

Scale Factor = 1.18

U Scale Value =  $1.18 \times 128 = 151.04$

U Scale Value = 151 (rounded to the nearest integer)

U Scale Value =  $10010111_b$

U Scale Value =  $97_h$

### CC2 BIT DESCRIPTION

#### V Scale Value (CC20–CC27)

These eight bits represent the value required to scale the V pixel data from 0.0 to 2.0 of its initial level. The value of these eight bits is calculated using the following equation:

$$V \text{ Scale Value} = \text{Scale Factor} \times 128$$

Example:

Scale Factor = 1.18

V Scale Value =  $1.18 \times 128 = 151.04$

V Scale Value = 151 (rounded to the nearest integer)

V Scale Value =  $10010111_b$

V Scale Value =  $97_h$

## HUE ADJUST CONTROL REGISTER (HCR)

(Address (SR5–SR0) = 20H)

The hue control register is an 8-bit-wide register used to adjust the hue on the composite and chroma outputs. Figure 74 shows the operation under control of this register.

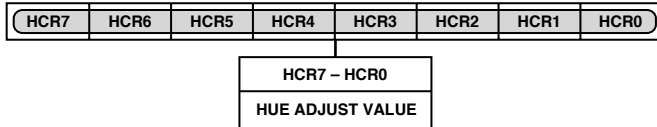

Figure 74. Hue Adjust Control Register

### HCR Bit Description

#### Hue Adjust Value (HCR0–HCR7)

These eight bits represent the value required to vary the hue of the video data, i.e., the variance in phase of the subcarrier during active video with respect to the phase of the subcarrier during the colorburst. The ADV7190/ADV7191 provides a range of  $\pm 22.5^\circ$  increments of  $0.17578125^\circ$ . For normal operation (zero adjustment) this register is set to 80Hex. FFHex and 00Hex represent the upper and lower limit (respectively) of adjustment attainable.

$Hue\ Adjust\ [^\circ] = 0.17578125^\circ \times (HCR_d - 128)$ ; for positive Hue Adjust Value

Example:

To adjust the hue by  $4^\circ$  write  $97_h$  to the Hue Adjust Control Register:

$$(4/0.17578125) + 128 = 151_d^* = 97_h$$

To adjust the hue by  $(-4^\circ)$  write  $69_h$  to the Hue Adjust Control Register:

$$(-4/0.17578125) + 128 = 10_d^* = 69_h$$

\*Rounded to the nearest integer.

### EXAMPLE

1. Standard: NTSC with Pedestal. To add +20 IRE brightness level, write  $28_h$  into the Brightness Control Register:

$$[Brightness\ Control\ Register\ Value]_h = [IRE\ Value \times 2.015631]_h = [20 \times 2.015631]_h = [40.31262]_h = 28_h$$

2. Standard: PAL. To add  $-7$  IRE brightness level write  $72_h$  into the Brightness Control Register:

$$[|IRE\ Value| \times 2.015631] = [7 \times 2.015631] = [14.109417] = 0001110_b$$

$$[0001110] \text{ into two's complement} = 1110010_b = 72_h$$

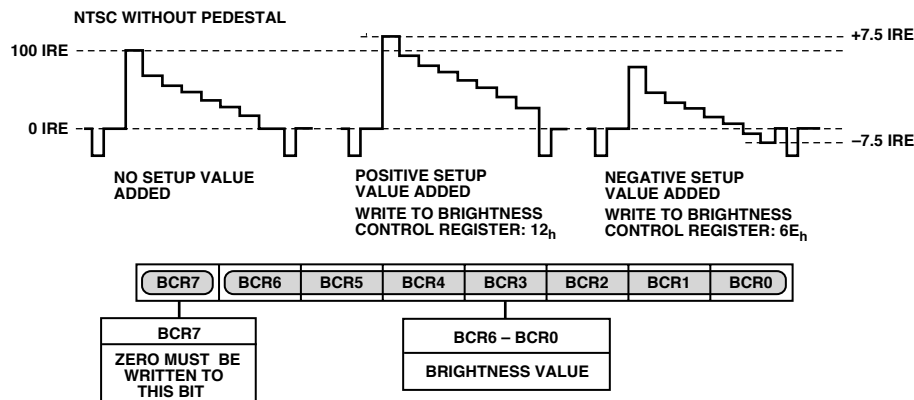

Figure 75. Brightness Control Register

## BRIGHTNESS CONTROL REGISTERS (BCR)

(Address (SR5–SR0) = 21H)

The brightness register is an 8-bit-wide register which allows brightness control. Figure 75 shows the operation under control of this register.

### BCR BIT DESCRIPTION

#### Brightness Value (BCR0–BCR6)

Seven bits of this 8-bit-wide register are used to control the brightness level. The brightness is controlled by adding a programmable setup level onto the scaled Y data. This brightness level can be a positive or negative value.

The programmable brightness level in NTSC without pedestal and PAL are max 15 IRE and min  $-7.5$  IRE, in NTSC with pedestal max 22.5 IRE and min 0 IRE.

Table IV. Brightness Control Register Value

Setup Level in NTSC with Pedestal	Setup Level in NTSC No Pedestal	Setup Level in PAL	Brightness Control Register Value
22.5 IRE	15 IRE	15 IRE	$1E_h$
15 IRE	7.5 IRE	7.5 IRE	$0F_h$
7.5 IRE	0 IRE	0 IRE	$00_h$
0 IRE	$-7.5$ IRE	$-7.5$ IRE	$71_h$

NOTE

Values in the range from  $3F_h$  to  $44_h$  might result in an invalid output signal.

# ADV7190/ADV7191

## SHARPNESS CONTROL REGISTER (PR) (Address (SR5–SR0) = 22H)

The sharpness response register is an 8-bit-wide register. The four MSBs are set to 0. The four LSBs are written to in order to select a desired filter response. Figure 76 shows the operation under control of this register.

### PR BIT DESCRIPTION

#### Sharpness Response Value (PR3–PR0)

These four bits are used to select the desired luma filter response. The option of twelve responses is given supporting a gain boost/attenuation in the range  $-4$  dB to  $+4$  dB. The value 12 (1100) written to these four bits corresponds to a boost of  $+4$  dB while the value 0 (0000) corresponds to  $-4$  dB. For normal operation these four bits are set to 6 (0110).

Note: Luma Filter Select has to be set to Extended Mode and Sharpness Filter Enable Control has to be enabled for settings in the Sharpness Control Register to take effect (MR2–04 = 100; MR74 = 1). See Internal Filter Response section.

#### Reserved (PR4–PR7)

A Logic 0 must be written to these bits.

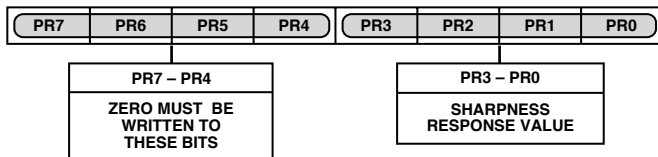

Figure 76. Sharpness Control Register

## DNR REGISTERS 2–0

### (DNR 2–DNR 0)

#### (Address (SR5–SR0) = 23H–25H)

The Digital Noise Reduction Registers are three 8-bit-wide registers. They are used to control the DNR processing. See Digital Noise Reduction section.

#### Coring Gain Border (DNR00–DNR03)

These four bits are assigned to the gain factor applied to border areas.

In DNR Mode the range of gain values is 0–1, in increments of 1/8. This factor is applied to the DNR filter output which lies below the set threshold range. The result is then subtracted from the original signal.

In DNR Sharpness Mode the range of gain values is 0–0.5 in increments of 1/16. This factor is applied to the DNR filter output which lies above the threshold range.

The result is added to the original signal.

#### Coring Gain Data (DNR04–DNR07)

These four bits are assigned to the gain factor applied to the luma data inside the MPEG pixel block.

In DNR Mode the range of gain values is 0–1, in increments of 1/8. This factor is applied to the DNR filter output which lies below the set threshold range. The result is then subtracted from the original signal.

In DNR Sharpness Mode the range of gain values is 0–0.5, in increments of 1/16. This factor is applied to the DNR filter output which lies above the threshold range. The result is added to the original signal.

Figures 77 and 78 show the various operations under the control of DNR Register 0.

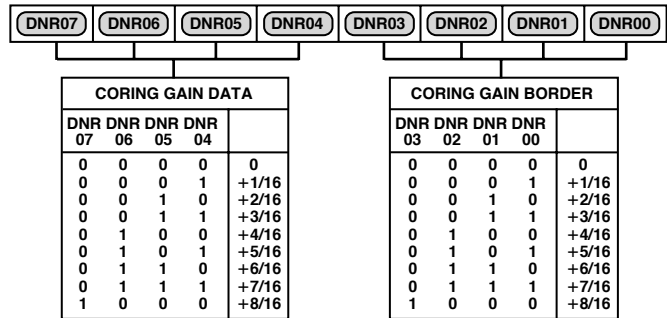

Figure 77. DNR Register 0 in Sharpness Mode

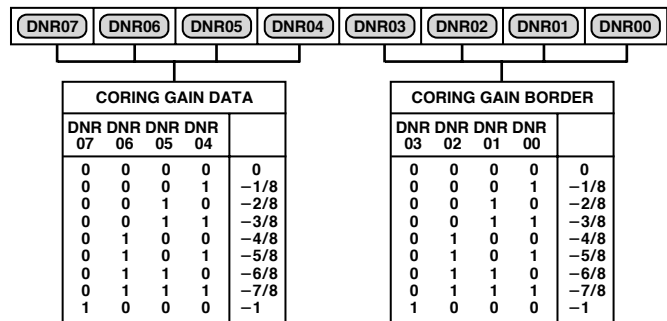

Figure 78. DNR Register 0 in DNR Mode

## DNR1 BIT DESCRIPTION

### DNR Threshold (DNR10–DNR15)

These six bits are used to define the threshold value in the range of 0 to 63. The range is an absolute value.

### Border Area (DNR16)

In setting DNR16 to a Logic 1 the block transition area can be defined to consist of four pixels. If this bit is set to a Logic 0 the border transition area consists of two pixels, where one pixel refers to two clock cycles at 27 MHz.

### Block Size Control (DNR17)

This bit is used to select the size of the data blocks to be processed (see Figure 79). Setting the block size control function to a Logic 1 defines a  $16 \times 16$  pixel data block, a Logic 0 defines an  $8 \times 8$  pixel data block, where one pixel refers to two clock cycles at 27 MHz.

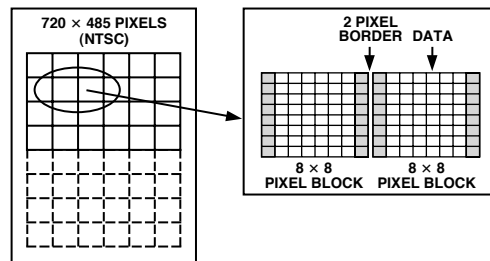

Figure 79. MPEG Block Diagram



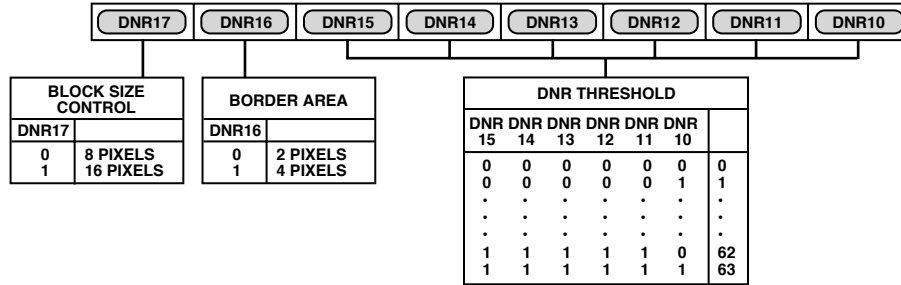

Figure 80. DNR Register 1

**DNR2 BIT DESCRIPTION**

**DNR Input Select (DNR20–DNR22)**

Three bits are assigned to select the filter that is applied to the incoming Y data. The signal that lies in the passband of the selected filter is the signal that will be DNR processed. Figure 81 shows the filter responses selectable with this control.

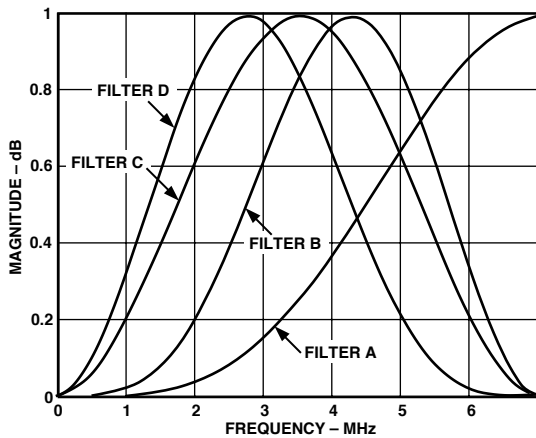

Figure 81. Filter Response of Filters Selectable

**DNR Mode Control (DNR23)**

This bit controls the DNR mode selected. A Logic 0 selects DNR mode, a Logic 1 selects DNR Sharpness mode.

DNR works on the principle of defining low amplitude, high-frequency signals as probable noise and subtracting this noise from the original signal.

In DNR mode, it is possible to subtract a fraction of the signal that lies below the set threshold, assumed to be noise, from the original signal. The threshold is set in DNR Register 1.

When DNR Sharpness mode is enabled it is possible to add a fraction of the signal that lies above the set threshold to the original signal, since this data is assumed to be valid data and not noise. The overall effect being that the signal will be boosted (similar to using Extended SSAF Filter).

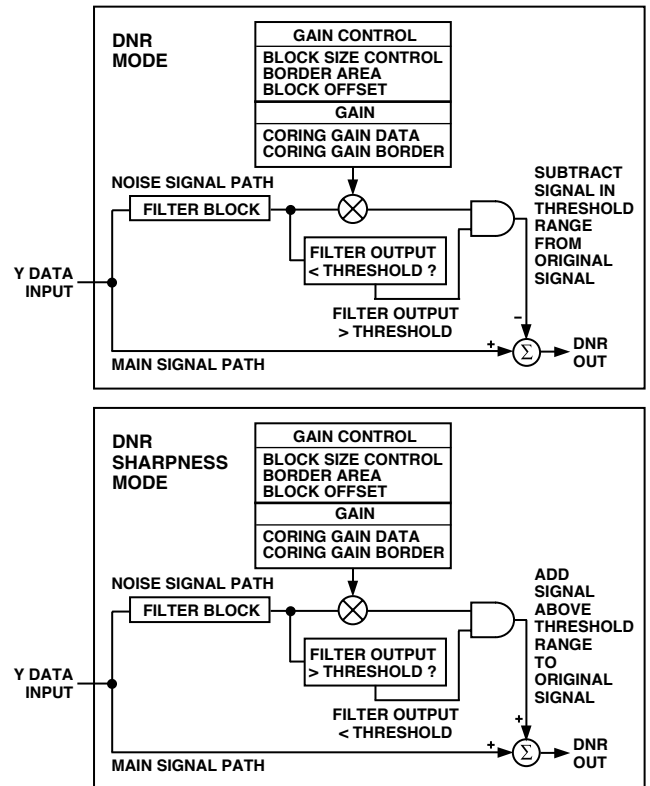

Figure 82. Block Diagram for DNR Mode and DNR Sharpness Mode

**Block Offset (DNR24–DNR27)**

Four bits are assigned to this control which allows a shift of the data block of 15 pixels maximum. Consider the coring gain positions fixed. The block offset shifts the data in steps of one pixel such that the border coring gain factors can be applied at the same position regardless of variations in input timing of the data.

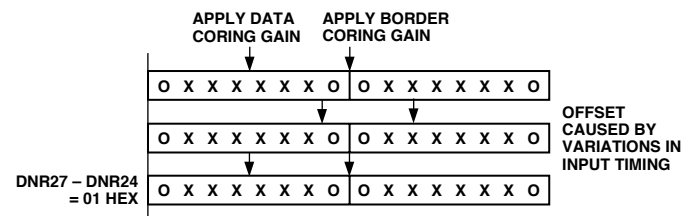

Figure 83. DNR27–DNR24, Block Offset Control

# ADV7190/ADV7191

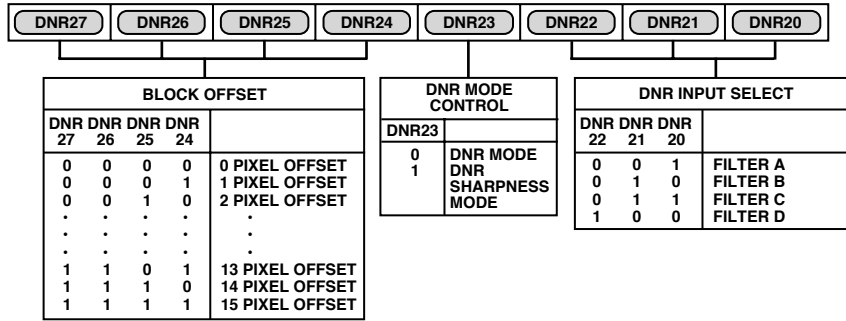

Figure 84. DNR Register 2

## GAMMA CORRECTION REGISTERS 0-13 (GAMMA CORRECTION 0-13) (Address (SR5-SR0) = 26H-32H)

The Gamma Correction Registers are fourteen 8-bit-wide registers. They are used to program the gamma correction Curves A and B.

Gamma correction is applied to compensate for the nonlinear relationship between signal input and brightness level output (as perceived on the CRT). It can also be applied wherever nonlinear processing is used.

Gamma correction uses the function:

$$Signal_{OUT} = (Signal_{IN})^\gamma$$

where

$$\gamma = \text{gamma power factor}$$

Gamma correction is performed on the luma data only. The user has the choice to use two different curves, Curve A, or Curve B. At any one time only one of these curves can be used.

The response of the curve is programmed at seven predefined locations. In changing the values at these locations the gamma curve can be modified. Between these points linear interpolation is used to generate intermediate values. Considering the curve to have a total length of 256 points, the seven locations are at: 32, 64, 96, 128, 160, 192, and 224.

Values at Location 0, 16, 240, and 255 are fixed and cannot be changed.

For the length of 16 to 240 the gamma correction curve has to be calculated as below:

$$y = x^\gamma$$

where

y = gamma corrected output

x = linear input signal

γ = gamma power factor

To program the gamma correction registers, the seven values for y have to be calculated using the following formula:

$$y_n = [x_{(n-16)} / (240-16)]^\gamma \times (240-16) + 16$$

where

$x_{(n-16)}$  = Value for x along x-axis

$y_n$  = Value for y along the y-axis, which has to be written into the gamma correction register

n = 32, 64, 96, 128, 160, 192, or 224

Example:

$$y_{32} = [(16/224)^{0.5} \times 224] + 16 = 76^*$$

$$y_{64} = [(48/224)^{0.5} \times 224] + 16 = 120^*$$

$$y_{96} = [(80/224)^{0.5} \times 224] + 16 = 150^*$$

$$y_{128} = [(112/224)^{0.5} \times 224] + 16 = 174^*$$

\*Rounded to the nearest integer.

The above will result in a gamma curve shown below, assuming a ramp signal as an input.

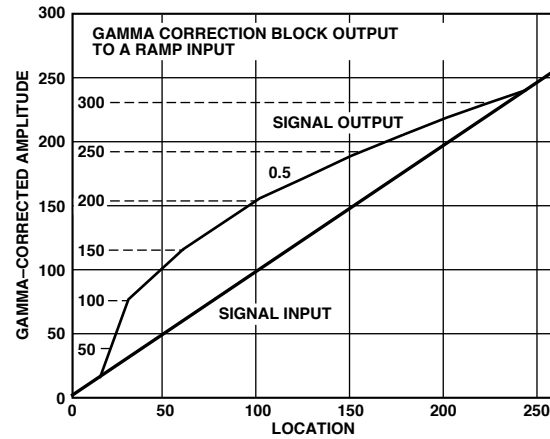

Figure 85. Signal Input (Ramp) and Signal Output for Gamma 0.5

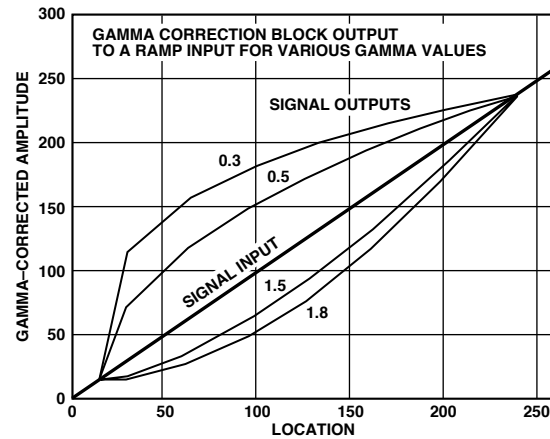

Figure 86. Signal Input (Ramp) and Selectable Gamma Output Curves

The gamma curves shown above are examples only, any user-defined curve is acceptable in the range of 16-240.

**BRIGHTNESS DETECT REGISTER**

(Address (SR5–SR0) = 34H)

The Brightness Detect Register is an 8-bit-wide register used only to read back data in order to monitor the brightness/darkness of the incoming video data on a field-by-field basis. The brightness information is read from the I<sup>2</sup>C and based on this information, the color controls or the gamma correction controls may be adjusted.

The luma data is monitored in the active video area only. The average brightness I<sup>2</sup>C register is updated on the falling edge of every VSYNC signal.

**OUTPUT CLOCK REGISTER (OCR 9–0)**

(Address (SR4–SR0) = 35H)

The Output Clock Register is an 8-bit-wide register. Figure 87 shows the various operations under the control of this register.

**OCR BIT DESCRIPTION**

**Reserved (OCR00)**

A Logic 0 must be written to this bit.

**CLKOUT Pin Control (OCR01)**

This bit enables the CLKOUT pin when set to 1 and, therefore, outputs a 54 MHz clock generated by the internal PLL. The PLL and 4× Oversampling have to be enabled for this control to take effect (MR61 = 0; MR16 = 1).

**Reserved (OCR02–03)**

A Logic 0 must be written to these bits.

**Reserved (OCR04–06)**

A Logic 1 must be written to these bits.

**Reserved (OCR07)**

A Logic 0 must be written to this bit.

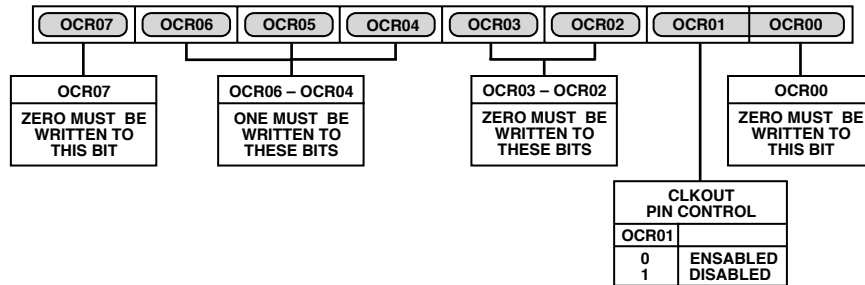

Figure 87. Output Clock Register (OCR)

# ADV7190/ADV7191

## APPENDIX 1

### BOARD DESIGN AND LAYOUT CONSIDERATIONS

The ADV7190/ADV7191 is a highly integrated circuit containing both precision analog and high-speed digital circuitry. It has been designed to minimize interference effects on the integrity of the analog circuitry by the high-speed digital circuitry. It is imperative that these same design and layout techniques be applied to the system-level design such that high-speed, accurate performance is achieved. The Recommended Analog Circuit Layout shows the analog interface between the device and monitor.

The layout should be optimized for lowest noise on the ADV7190/ADV7191 power and ground lines by shielding the digital inputs and providing good decoupling. The lead length between groups of  $V_{AA}$  and AGND pins should be minimized in order to minimize inductive ringing.

#### Ground Planes

The ground plane should encompass all ADV7190/ADV7191 ground pins, voltage reference circuitry, power supply bypass circuitry for the ADV7190/ADV7191, the analog output traces, and all the digital signal traces leading up to the ADV7190/ADV7191.

#### Power Planes

The ADV7190/ADV7191 and any associated analog circuitry should have its own power plane, referred to as the analog power plane ( $V_{AA}$ ). This power plane should be connected to the regular PCB power plane ( $V_{CC}$ ) at a single point through a ferrite bead. This bead should be located within three inches of the ADV7190/ADV7191.

The metallization gap separating device power plane and board power plane should be as narrow as possible to minimize the obstruction to the flow of heat from the device into the general board.

The PCB power plane should provide power to all digital logic on the PC board, and the analog power plane should provide power to all ADV7190/ADV7191 power pins and voltage reference circuitry.

Plane-to-plane noise coupling can be reduced by ensuring that portions of the regular PCB power and ground planes do not overlay portions of the analog power plane, unless they can be arranged so the plane-to-plane noise is common-mode.

#### Supply Decoupling

For optimum performance, bypass capacitors should be installed using the shortest leads possible, consistent with reliable operation,

to reduce the lead inductance. Best performance is obtained with 0.1  $\mu\text{F}$  ceramic capacitor decoupling. Each group of  $V_{AA}$  pins on the ADV7190/ADV7191 must have at least one 0.1  $\mu\text{F}$  decoupling capacitor to AGND. These capacitors should be placed as close as possible to the device.

It is important to note that while the ADV7190/ADV7191 contains circuitry to reject power supply noise, this rejection decreases with frequency. If a high-frequency switching power supply is used, the designer should pay close attention to reducing power supply noise and consider using a three-terminal voltage regulator for supplying power to the analog power plane.

#### Digital Signal Interconnect

The digital inputs to the ADV7190/ADV7191 should be isolated as much as possible from the analog outputs and other analog circuitry. Also, these input signals should not overlay the analog power plane.

Due to the high clock rates involved, long clock lines to the ADV7190/ADV7191 should be avoided to reduce noise pickup.

Any active termination resistors for the digital inputs should be connected to the regular PCB power plane ( $V_{CC}$ ), and not the analog power plane.

#### Analog Signal Interconnect

The ADV7190/ADV7191 should be located as close as possible to the output connectors to minimize noise pickup and reflections due to impedance mismatch.

The video output signals should overlay the ground plane, and not the analog power plane, to maximize the high frequency power supply rejection.

Digital inputs, especially pixel data inputs and clocking signals should never overlay any of the analog signal circuitry and should be kept as far away as possible.

For best performance, the outputs should each have a 300  $\Omega$  load resistor connected to AGND. These resistors should be placed as close as possible to the ADV7190/ADV7191 so as to minimize reflections.

The ADV7190/ADV7191 should have no inputs left floating. Any inputs that are not required should be tied to ground.

APPENDIX 1  
BOARD LAYOUT

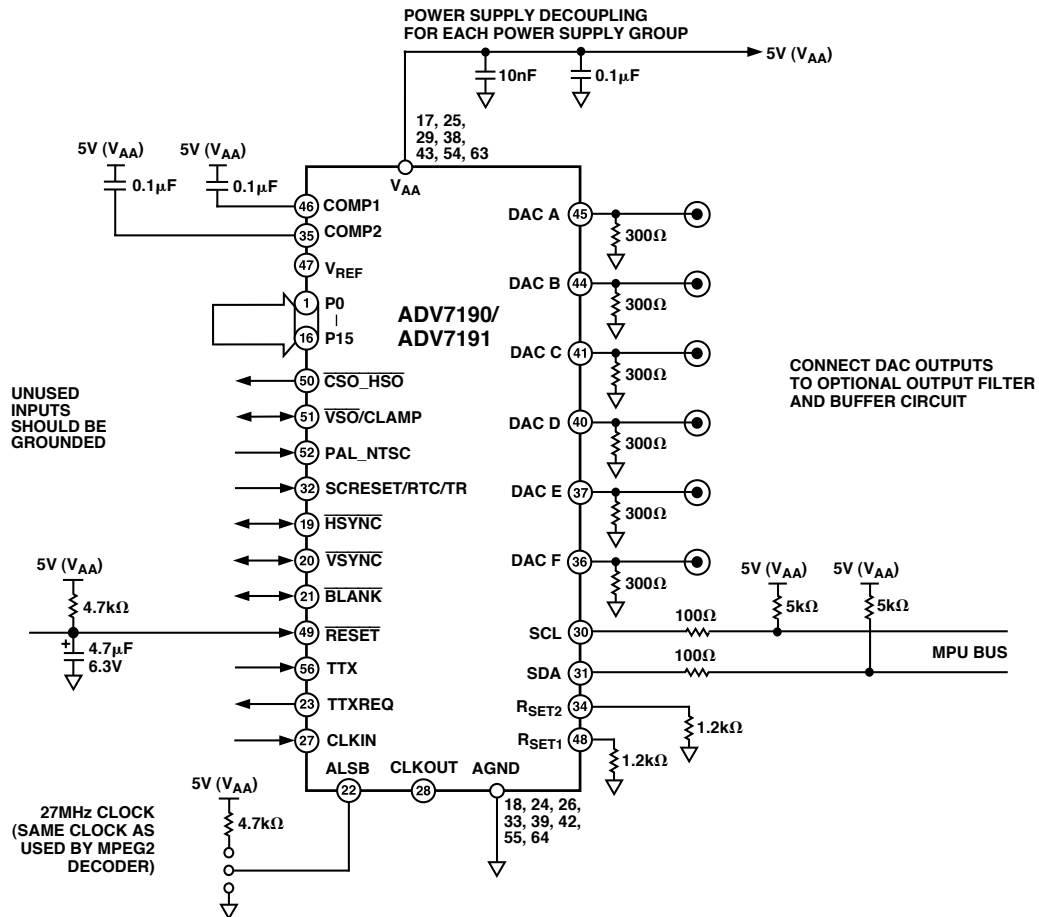

Figure 88. Recommended Analog Circuit Layout

# ADV7190/ADV7191

## APPENDIX 2 CLOSED CAPTIONING

The ADV7190/ADV7191 supports closed captioning conforming to the standard television synchronizing waveform for color transmission. Closed captioning is transmitted during the blanked active line time of Line 21 of the odd fields and Line 284 of even fields.

Closed captioning consists of a seven-cycle sinusoidal burst that is frequency and phase locked to the caption data. After the clock run-in signal, the blanking level is held for two data bits and is followed by a Logic Level 1 start bit. Sixteen bits of data follow the start bit. These consist of two eight-bit bytes, seven data bits, and one odd parity bit. The data for these bytes is stored in Closed Captioning Data Registers 0 and 1.

The ADV7190/ADV7191 also supports the extended closed captioning operation that is active during even fields and is encoded on Scan Line 284. The data for this operation is stored in Closed Captioning Extended Data Registers 0 and 1.

All clock run-in signals and timing to support closed captioning on Lines 21 and 284 are generated automatically by the ADV7190/ADV7191. All pixel inputs are ignored during Lines 21 and 284 if closed captioning is enabled.

FCC Code of Federal Regulations (CFR) 47 Section 15.119 and EIA608 describe the closed captioning information for Lines 21 and 284.

The ADV7190/ADV7191 uses a single buffering method. This means that the closed captioning buffer is only one byte deep, therefore there will be no frame delay in outputting the closed captioning data, unlike other two byte deep buffering systems. The data must be loaded one line before (Line 20 or Line 283) it is outputted on Line 21 and Line 284. A typical implementation of this method is to use  $\overline{\text{VSYNC}}$  to interrupt a microprocessor, which in turn, will load the new data (two bytes) every field. If no new data is required for transmission, 0s must be inserted in both data registers, this is called NULLING. It is also important to load *control codes*, all of which are double bytes on Line 21, or a TV will not recognize them. If there is a message like *Hello World*, which has an odd number of characters, it is important to pad it out to even in order to get *end of caption* 2-byte control code to land in the same field.

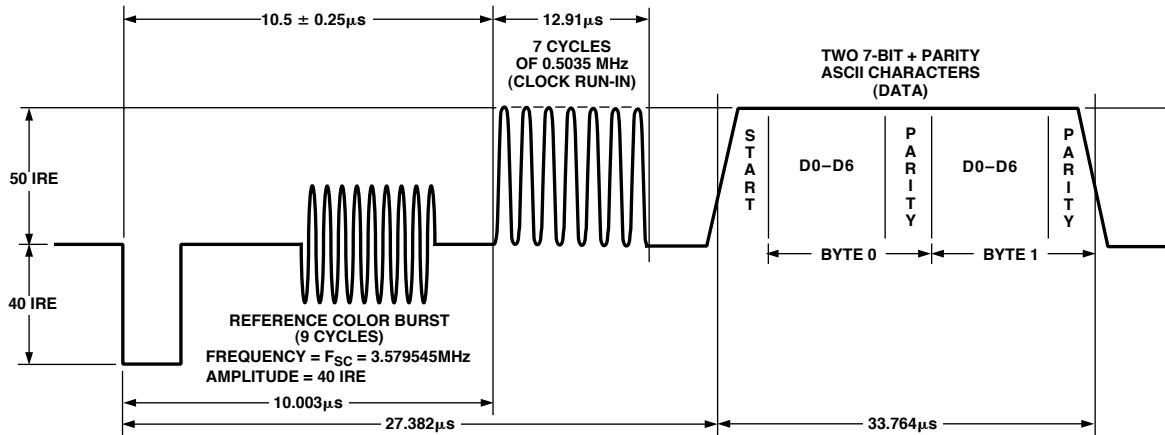

Figure 89. Closed Captioning Waveform (NTSC)

APPENDIX 3

COPY GENERATION MANAGEMENT SYSTEM (CGMS)

The ADV7190/ADV7191 supports Copy Generation Management System (CGMS) conforming to the standard. CGMS data is transmitted on Line 20 of the odd fields and Line 283 of even fields. Bits C/W05 and C/W06 control whether or not CGMS data is outputted on ODD and EVEN fields. CGMS data can only be transmitted when the ADV7190/ADV7191 is configured in NTSC mode. The CGMS data is 20 bits long, the function of each of these bits is as shown below. The CGMS data is preceded by a reference pulse of the same amplitude and duration as a CGMS bit, see Figure 94. These bits are output from the configuration registers in the following order: C/W00 = C16, C/W01 = C17, C/W02 = C18, C/W03 = C19, C/W10 = C8, C/W11 = C9, C/W12 = C10, C/W13 = C11, C/W14 = C12, C/W15 = C13, C/W16 = C14, C/W17 = C15, C/W20 = C0, C/W21 = C1, C/W22 = C2, C/W23 = C3, C/W24 = C4, C/W25 = C5, C/W26 = C6, C/W27 = C7. If the bit C/W04 is set to a Logic 1, the last six bits C19–C14 which comprise the 6-bit CRC check sequence are calculated automatically on the ADV7190/ADV7191 based on the lower 14 bits (C0–C13) of the data in the data registers and output with the remaining 14-bits to form the complete 20-bits of the CGMS data. The calculation of the CRC sequence is based on the polynomial  $X^6 + X + 1$  with a preset value of 111111. If C/W04 is set to a Logic 0, all 20 bits (C0–C19) are output directly from the CGMS registers (no CRC calculated, must be calculated by the user).

Function of CGMS Bits

Word 0 – 6 Bits

Word 1 – 4 Bits

Word 2 – 6 Bits

CRC – 6 Bits    CRC Polynomial =  $X^6 + X + 1$  (Preset to 111111)

WORD 0		1	0
B1	Aspect Ratio	16:9	4:3
B2	Display Format	Letterbox	Normal
B3	Undefined		
WORD 0			
B4, B5, B6	Identification Information About Video and Other Signals (e.g., Audio)		
WORD 1			
B7, B8, B9, B10	Identification Signal Incidental to Word 0		
WORD 2			
B11, B12, B13, B14	Identification Signal and Information Incidental to Word 0		

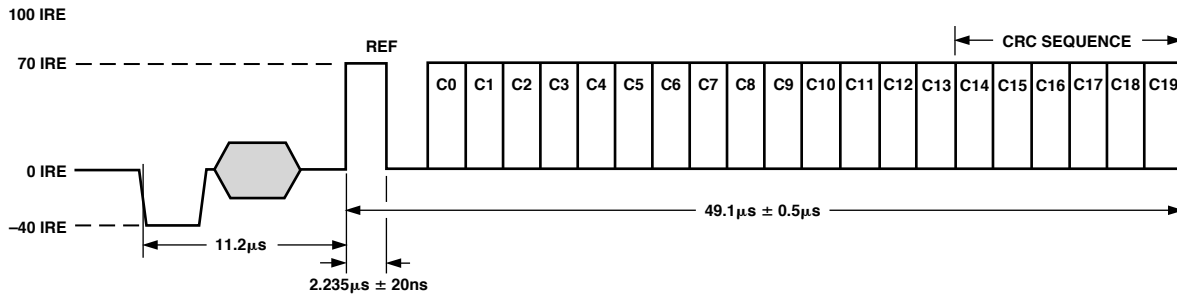

Figure 90. CGMS Waveform Diagram

# ADV7190/ADV7191

## APPENDIX 4

### WIDE SCREEN SIGNALING (WSS)

The ADV7190/ADV7191 supports Wide Screen Signaling (WSS) conforming to the standard. WSS data is transmitted on Line 23. WSS data can only be transmitted when the ADV7190/ADV7191 is configured in PAL mode. The WSS data is 14-bits long, the function of each of these bits is as shown below. The WSS data is preceded by a run-in sequence and a Start Code, see Figure 91. The bits are output from the configuration registers in the following order: C/W20 = W0, C/W21 = W1, C/W22 = W2, C/W23 = W3, C/W24 = W4, C/W25 = W5, C/W26 = W6, C/W27 = W7, C/W10 = W8, C/W11 = W9, C/W12 = W10, C/W13 = W11, C/W14 = W12, C/W15 = W13. If the bit C/W07 is set to a Logic 1, it enables the WSS data to be transmitted on Line 23. The latter portion of Line 23 (42.5  $\mu$ s from the falling edge of  $\overline{\text{HSYNC}}$ ) is available for the insertion of video.

#### Function of CGMS Bits

Bit 0–Bit 2 Aspect Ratio/Format/Position

Bit 3 Is Odd Parity Check of Bit 0–Bit 2

B0, B1, B2, B3	Aspect Ratio	Format	Position
0 0 0 1	4:3	Full Format	Nonapplicable
1 0 0 0	14:9	Letterbox	Center
0 1 0 0	14:9	Letterbox	Top
1 1 0 1	16:9	Letterbox	Center
0 0 1 0	16:9	Letterbox	Top
1 0 1 1	>16:9	Letterbox	Center
0 1 1 1	14:9	Full Format	Center
1 1 1 0	16:9	Nonapplicable	Nonapplicable

B4	0	Camera Mode
	1	Film Mode
B5	0	Standard Coding
	1	Motion Adaptive Color Plus
B6	0	No Helper
	1	Modulated Helper
B7	RESERVED	
B9	B10	
	0	0 No Open Subtitles
	1	0 Subtitles in Active Image Area
	0	1 Subtitles Out of Active Image Area
	1	1 RESERVED
B11	0	No Surround Sound Information
	1	Surround Sound Mode
B12	RESERVED	
B13	RESERVED	

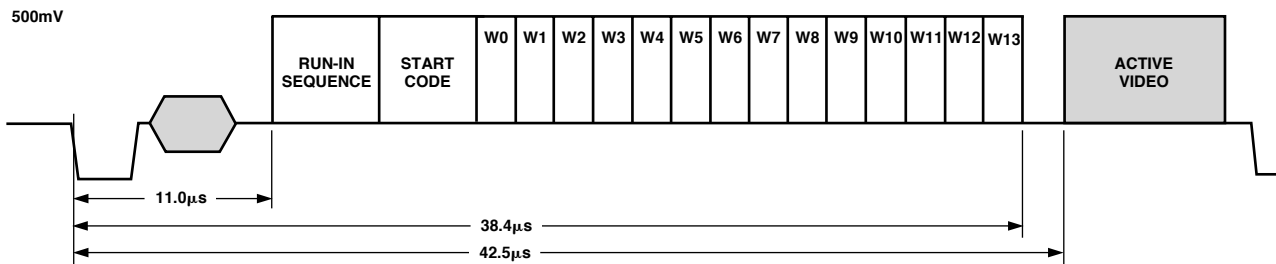

Figure 91. WSS Waveform Diagram



APPENDIX 5  
TELETEXT INSERTION

Time,  $t_{PD}$ , is the time needed by the ADV7190/ADV7191 to interpolate input data on TTX and insert it onto the CVBS or Y outputs, such that it appears  $t_{SYNNTXOUT} = 10.2 \mu s$  after the leading edge of the horizontal signal. Time,  $TTX_{DEL}$ , is the pipeline delay time by the source that is gated by the TTXREQ signal in order to deliver TTX data.

With the programmability that is offered with TTXREQ signal on the Rising/Falling edges, the TTX data is always inserted at the correct position of  $10.2 \mu s$  after the leading edge of Horizontal Sync pulse, which enables a source interface with variable pipeline delays.

The width of the TTXREQ signal must always be maintained so it allows the insertion of 360 (in order to comply with the Teletext Standard PAL-WST) teletext bits at a text data rate of 6.9375 Mb/s. This is achieved by setting TC03-TC00 to 0. The insertion window is not open if the Teletext Enable bit (MR33) is set to 0.

**Teletext Protocol**

The relationship between the TTX bit clock (6.9375 MHz) and the system CLOCK (27 MHz) for 50 Hz is given as follows:

$$(27 \text{ MHz}/4) = 6.75 \text{ MHz}$$

$$(6.9375 \times 10^6 / 6.75 \times 10^6) = 1.027777$$

Thus 37 TTX bits correspond to 144 clocks (27 MHz), each bit has a width of almost four clock cycles. The ADV7190/ADV7191 uses an internal sequencer and variable phase interpolation filter to minimize the phase jitter and thus generate a bandlimited signal which can be output on the CVBS and Y outputs.

At the TTX input the bit duration scheme repeats after every 37 TTX bits or 144 clock cycles. The protocol requires that TTX Bits 10, 19, 28, 37 are carried by three clock cycles, all other bits by four clock cycles. After 37 TTX bits, the next bits with three clock cycles are Bits 47, 56, 65, and 74. This scheme holds for all following cycles of 37 TTX bits, until all 360 TTX bits are completed. All teletext lines are implemented in the same way. Individual control of teletext lines are controlled by Teletext Setup Registers.

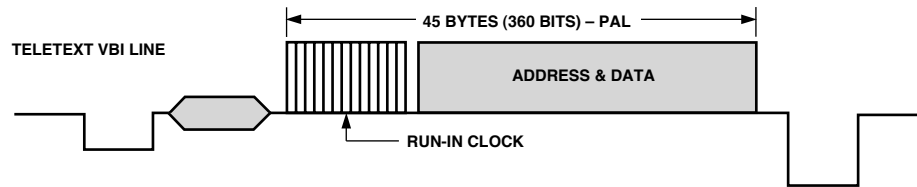

Figure 92. Teletext VBI Line

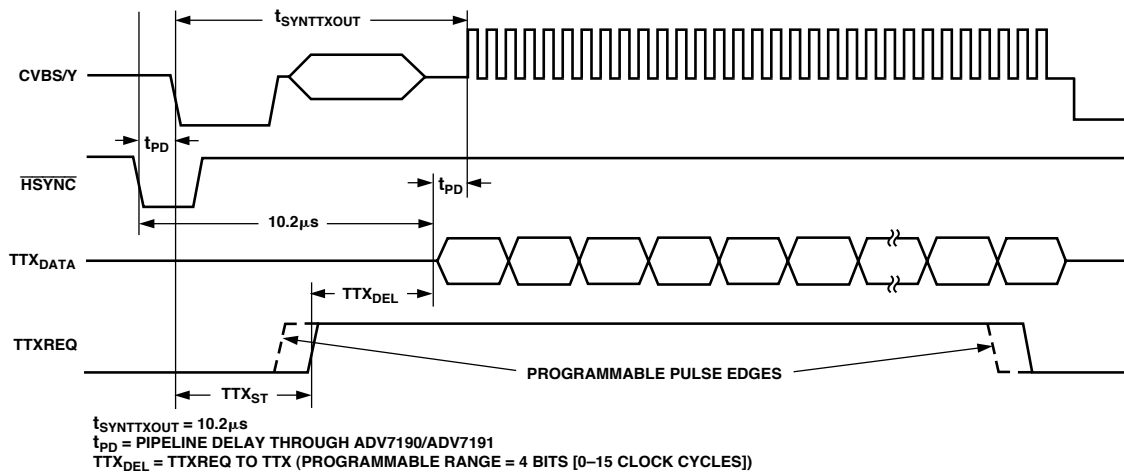

Figure 93. Teletext Functionality Diagram

# ADV7190/ADV7191

## APPENDIX 6

### OPTIONAL OUTPUT FILTER

If an output filter is required for the CVBS, YUV, Chroma, and RGB outputs of the ADV7190/ADV7191, the filter in Figure 94 can be used in 2× Oversampling Mode. Figure 96 shows a filter that can be used in 4× Oversampling Mode. The plot of the filter characteristics are shown in Figures 95 and 97. An output filter is not required if the outputs of the ADV7190/ADV7191 are connected to most analog monitors, or TVs; however, if the output signals are applied to a system where sampling is used (e.g., Digital TVs), a filter is required to prevent aliasing.

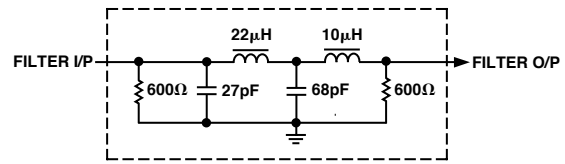

Figure 96. Output Filter for 4× Oversampling Mode

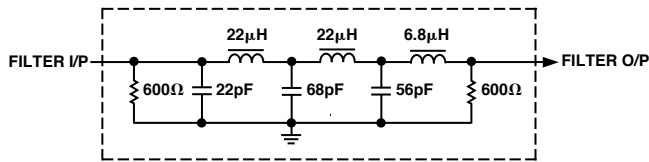

Figure 94. Output Filter for 2× Oversampling Mode

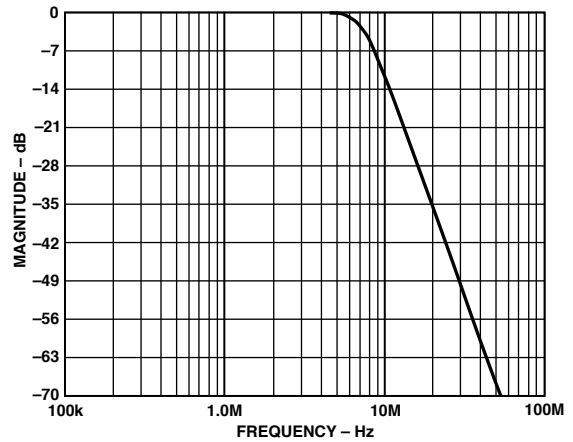

Figure 97. Output Filter Plot for 4× Oversampling Filter

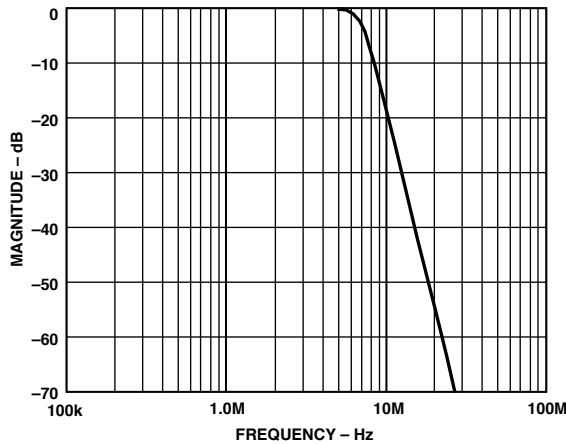

Figure 95. Output Filter Plot for 2× Oversampling Filter

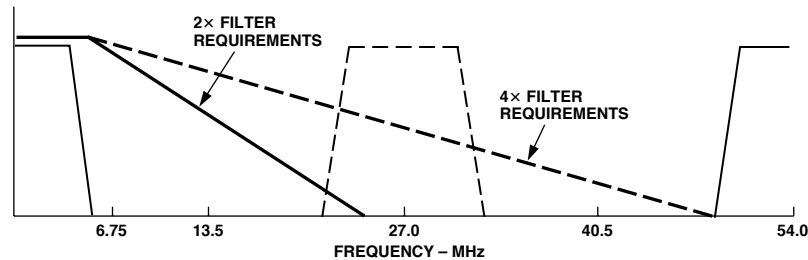

Figure 98. Output Filter Requirements in 4× Oversampling Mode

APPENDIX 7  
DAC BUFFERING

External buffering is needed on the ADV7190/ADV7191 DAC outputs. The configuration in Figure 99 is recommended.

When calculating absolute output full-scale current and voltage use the following equations:

$$V_{OUT} = I_{OUT} \times R_{LOAD}$$

$$I_{OUT} = (V_{REF} \times K) / R_{SET}$$

$$K = 4.2146 \text{ constant, } V_{REF} = 1.235 \text{ V}$$

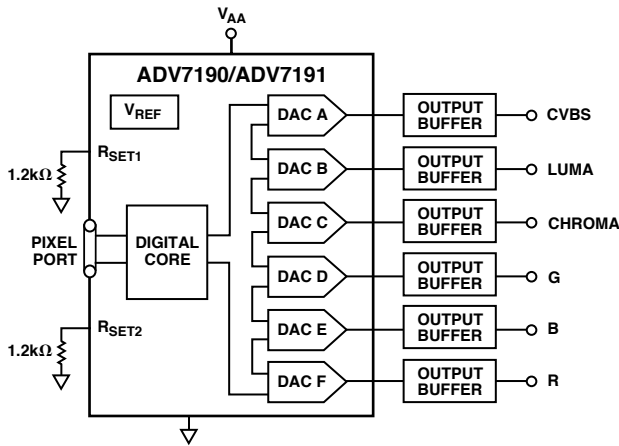

Figure 99. Output DAC Buffering Configuration

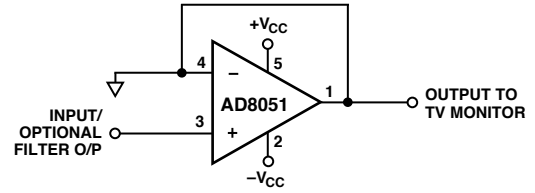

Figure 100. Recommended DAC Output Buffer Using an Op Amp

# ADV7190/ADV7191

## APPENDIX 8

### RECOMMENDED REGISTER VALUES

The ADV7190/ADV7191 registers can be set depending on the user standard required. The following examples give the various register formats for several video standards.

NTSC (F <sub>SC</sub> = 3.5795454 MHz)		PAL B, D, G, H, I (F <sub>SC</sub> = 4.43361875 MHz)	
Address	Data	Address	Data
00Hex	Mode Register 0	00Hex	Mode Register 0
01Hex	Mode Register 1	01Hex	Mode Register 1
02Hex	Mode Register 2	02Hex	Mode Register 2
03Hex	Mode Register 3	03Hex	Mode Register 3
04Hex	Mode Register 4	04Hex	Mode Register 4
05Hex	Mode Register 5	05Hex	Mode Register 5
06Hex	Mode Register 6	06Hex	Mode Register 6
07Hex	Mode Register 7	07Hex	Mode Register 7
08Hex	Mode Register 8	08Hex	Mode Register 8
09Hex	Mode Register 9	09Hex	Mode Register 9
0AHex	Timing Register 0	0AHex	Timing Register 0
0BHex	Timing Register 1	0BHex	Timing Register 1
0CHex	Subcarrier Frequency Register 0	0CHex	Subcarrier Frequency Register 0
0DHex	Subcarrier Frequency Register 1	0DHex	Subcarrier Frequency Register 1
0EHex	Subcarrier Frequency Register 2	0EHex	Subcarrier Frequency Register 2
0FHex	Subcarrier Frequency Register 3	0FHex	Subcarrier Frequency Register 3
10Hex	Subcarrier Phase Register	10Hex	Subcarrier Phase Register
11Hex	Closed Captioning Ext Register 0	11Hex	Closed Captioning Ext Register 0
12Hex	Closed Captioning Ext Register 1	12Hex	Closed Captioning Ext Register 1
13Hex	Closed Captioning Register 0	13Hex	Closed Captioning Register 0
14Hex	Closed Captioning Register 1	14Hex	Closed Captioning Register 1
15Hex	Pedestal Control Register 0	15Hex	Pedestal Control Register 0
16Hex	Pedestal Control Register 1	16Hex	Pedestal Control Register 1
17Hex	Pedestal Control Register 2	17Hex	Pedestal Control Register 2
18Hex	Pedestal Control Register 3	18Hex	Pedestal Control Register 3
19Hex	CGMS_WSS Reg 0	19Hex	CGMS_WSS Reg 0
1AHex	CGMS_WSS Reg 1	1AHex	CGMS_WSS Reg 1
1BHex	CGMS_WSS Reg 2	1BHex	CGMS_WSS Reg 2
1CHex	Teletext Control Register	1CHex	Teletext Control Register
1DHex	Contrast Control Register	1DHex	Contrast Control Register
1EHex	Color Control Register 1	1EHex	Color Control Register 1
1FHex	Color Control Register 2	1FHex	Color Control Register 2
20Hex	Hue Control Register	20Hex	Hue Control Register
21Hex	Brightness Control Register	21Hex	Brightness Control Register
22Hex	Sharpness Response Register	22Hex	Sharpness Response Register
23Hex	DNR 0	23Hex	DNR0
24Hex	DNR 1	24Hex	DNR1
25Hex	DNR 2	25Hex	DNR2
35Hex	Output Clock Register	35Hex	Output Clock Register

## PAL N (F<sub>SC</sub> = 4.43361875 MHz)

## PAL 60 (F<sub>SC</sub> = 4.43361875 MHz)

Address	Data	Address	Data
00Hex	Mode Register 0	00Hex	Mode Register 0
01Hex	Mode Register 1	01Hex	Mode Register 1
02Hex	Mode Register 2	02Hex	Mode Register 2
03Hex	Mode Register 3	03Hex	Mode Register 3
04Hex	Mode Register 4	04Hex	Mode Register 4
05Hex	Mode Register 5	05Hex	Mode Register 5
06Hex	Mode Register 6	06Hex	Mode Register 6
07Hex	Mode Register 7	07Hex	Mode Register 7
08Hex	Mode Register 8	08Hex	Mode Register 8
09Hex	Mode Register 9	09Hex	Mode Register 9
0AHex	Timing Register 0	0AHex	Timing Register 0
0BHex	Timing Register 1	0BHex	Timing Register 1
0CHex	Subcarrier Frequency Register 0	0CHex	Subcarrier Frequency Register 0
0DHex	Subcarrier Frequency Register 1	0DHex	Subcarrier Frequency Register 1
0EHex	Subcarrier Frequency Register 2	0EHex	Subcarrier Frequency Register 2
0FHex	Subcarrier Frequency Register 3	0FHex	Subcarrier Frequency Register 3
10Hex	Subcarrier Phase Register	10Hex	Subcarrier Phase Register
11Hex	Closed Captioning Ext Register 0	11Hex	Closed Captioning Ext Register 0
12Hex	Closed Captioning Ext Register 1	12Hex	Closed Captioning Ext Register 1
13Hex	Closed Captioning Register 0	13Hex	Closed Captioning Register 0
14Hex	Closed Captioning Register 1	14Hex	Closed Captioning Register 1
15Hex	Pedestal Control Register 0	15Hex	Pedestal Control Register 0
16Hex	Pedestal Control Register 1	16Hex	Pedestal Control Register 1
17Hex	Pedestal Control Register 2	17Hex	Pedestal Control Register 2
18Hex	Pedestal Control Register 3	18Hex	Pedestal Control Register 3
19Hex	CGMS_WSS Reg 0	19Hex	CGMS_WSS Reg 0
1AHex	CGMS_WSS Reg 1	1AHex	CGMS_WSS Reg 1
1BHex	CGMS_WSS Reg 2	1BHex	CGMS_WSS Reg 2
1CHex	Teletext Control Register	1CHex	Teletext Control Register
1DHex	Contrast Control Register	1DHex	Contrast Control Register
1EHex	Color Control Register 1	1EHex	Color Control Register 1
1FHex	Color Control Register 2	1FHex	Color Control Register 2
20Hex	Hue Control Register	20Hex	Hue Control Register
21Hex	Brightness Control Register	21Hex	Brightness Control Register
22Hex	Sharpness Response Register	22Hex	Sharpness Response Register
23Hex	DNR 0	23Hex	DNR 0
24Hex	DNR 1	24Hex	DNR 1
25Hex	DNR 2	25Hex	DNR 2
35Hex	Output Clock Register	35Hex	Output Clock Register

# ADV7190/ADV7191

PAL M (F<sub>SC</sub> = 3.57561149 MHz)

Address		Data	Address		Data
00Hex	Mode Register 0	12Hex	14Hex	Closed Captioning Register 1	00Hex
01Hex	Mode Register 1	3FHex	15Hex	Pedestal Control Register 0	00Hex
02Hex	Mode Register 2	62Hex	16Hex	Pedestal Control Register 1	00Hex
03Hex	Mode Register 3	00Hex	17Hex	Pedestal Control Register 2	00Hex
04Hex	Mode Register 4	00Hex	18Hex	Pedestal Control Register 3	00Hex
05Hex	Mode Register 5	00Hex	19Hex	CGMS_WSS Reg 0	00Hex
06Hex	Mode Register 6	00Hex	1AHex	CGMS_WSS Reg 1	00Hex
07Hex	Mode Register 7	00Hex	1BHex	CGMS_WSS Reg 2	00Hex
08Hex	Mode Register 8	04Hex	1CHex	Teletext Control Register	00Hex
09Hex	Mode Register 9	00Hex	1DHex	Contrast Control Register	00Hex
0AHex	Timing Register 0	08Hex	1EHex	Color Control Register 1	00Hex
0BHex	Timing Register 1	00Hex	1FHex	Color Control Register 2	00Hex
0CHex	Subcarrier Frequency Register 0	A3Hex	20Hex	Hue Control Register	00Hex
0DHex	Subcarrier Frequency Register 1	EFHex	21Hex	Brightness Control Register	00Hex
EHex	Subcarrier Frequency Register 2	E6Hex	22Hex	Sharpness Response Register	00Hex
0FHex	Subcarrier Frequency Register 3	21Hex	23Hex	DNR 0	44Hex
10Hex	Subcarrier Phase Register	00Hex	24Hex	DNR 1	20Hex
11Hex	Closed Captioning Ext Register 0	00Hex	25Hex	DNR 2	00Hex
12Hex	Closed Captioning Ext Register 1	00Hex	35Hex	Output Clock Register	70Hex
13Hex	Closed Captioning Register 0	00Hex			

POWER-ON RESET REGISTER VALUES

POWER-ON RESET REG VALUES  
(PAL\_NTSC = 0, NTSC Selected)

Address	Data
00Hex	Mode Register 0
01Hex	Mode Register 1
02Hex	Mode Register 2
03Hex	Mode Register 3
04Hex	Mode Register 4
05Hex	Mode Register 5
06Hex	Mode Register 6
07Hex	Mode Register 7
08Hex	Mode Register 8
09Hex	Mode Register 9
0AHex	Timing Register 0
0BHex	Timing Register 1
0CHex	Subcarrier Frequency Register 0
0DHex	Subcarrier Frequency Register 1
0EHex	Subcarrier Frequency Register 2
0FHex	Subcarrier Frequency Register 3
10Hex	Subcarrier Phase Register
11Hex	Closed Captioning Ext Register 0
12Hex	Closed Captioning Ext Register 1
13Hex	Closed Captioning Register 0
14Hex	Closed Captioning Register 1
15Hex	Pedestal Control Register 0
16Hex	Pedestal Control Register 1
17Hex	Pedestal Control Register 2
18Hex	Pedestal Control Register 3
19Hex	CGMS_WSS Reg 0
1AHex	CGMS_WSS Reg 1
1BHex	CGMS_WSS Reg 2
1CHex	Teletext Control Register
1DHex	Contrast Control Register
1EHex	Color Control Register 1
1FHex	Color Control Register 2
20Hex	Hue Control Register
21Hex	Brightness Control Register
22Hex	Sharpness Response Register
23Hex	DNR 0
24Hex	DNR 1
25Hex	DNR 2
26Hex	Gamma 0
27Hex	Gamma 1
28Hex	Gamma 2
29Hex	Gamma 3
2AHex	Gamma 4
2BHex	Gamma 5
2CHex	Gamma 6
2DHex	Gamma 7
2EHex	Gamma 8
2FHex	Gamma 9
30Hex	Gamma 10
31Hex	Gamma 11
32Hex	Gamma 12
33Hex	Gamma 13
34Hex	Brightness Detect Register
35Hex	Output Clock Register

POWER-ON RESET REG VALUES  
(PAL\_NTSC = 1, PAL Selected)

Address	Data
00Hex	Mode Register 0
01Hex	Mode Register 1
02Hex	Mode Register 2
03Hex	Mode Register 3
04Hex	Mode Register 4
05Hex	Mode Register 5
06Hex	Mode Register 6
07Hex	Mode Register 7
08Hex	Mode Register 8
09Hex	Mode Register 9
0AHex	Timing Register 0
0BHex	Timing Register 1
0CHex	Subcarrier Frequency Register 0
0DHex	Subcarrier Frequency Register 1
0EHex	Subcarrier Frequency Register 2
0FHex	Subcarrier Frequency Register 3
10Hex	Subcarrier Phase Register
11Hex	Closed Captioning Ext Register 0
12Hex	Closed Captioning Ext Register 1
13Hex	Closed Captioning Register 0
14Hex	Closed Captioning Register 1
15Hex	Pedestal Control Register 0
16Hex	Pedestal Control Register 1
17Hex	Pedestal Control Register 2
18Hex	Pedestal Control Register 3
19Hex	CGMS_WSS Reg 0
1AHex	CGMS_WSS Reg 1
1BHex	CGMS_WSS Reg 2
1CHex	Teletext Control Register
1DHex	Contrast Control Register
1EHex	Color Control Register 1
1FHex	Color Control Register 2
20Hex	Hue Control Register
21Hex	Brightness Control Register
22Hex	Sharpness Response Register
23Hex	DNR 0
24Hex	DNR 1
25Hex	DNR 2
26Hex	Gamma 0
27Hex	Gamma 1
28Hex	Gamma 2
29Hex	Gamma 3
2AHex	Gamma 4
2BHex	Gamma 5
2CHex	Gamma 6
2DHex	Gamma 7
2EHex	Gamma 8
2FHex	Gamma 9
30Hex	Gamma 10
31Hex	Gamma 11
32Hex	Gamma 12
33Hex	Gamma 13
34Hex	Brightness Detect Register
35Hex	Output Clock Register

## APPENDIX 9

### NTSC WAVEFORMS (WITH PEDESTAL)

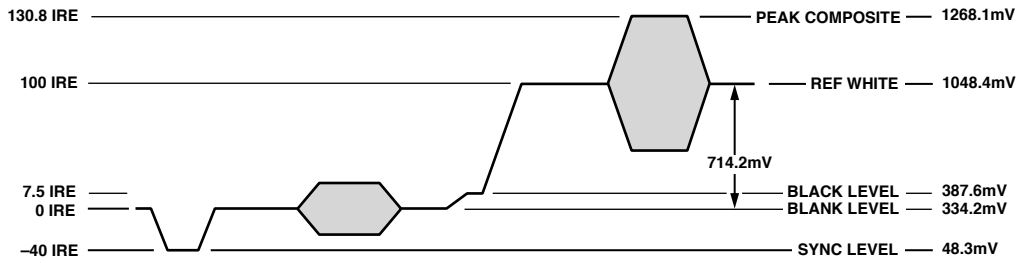

Figure 101. NTSC Composite Video Levels

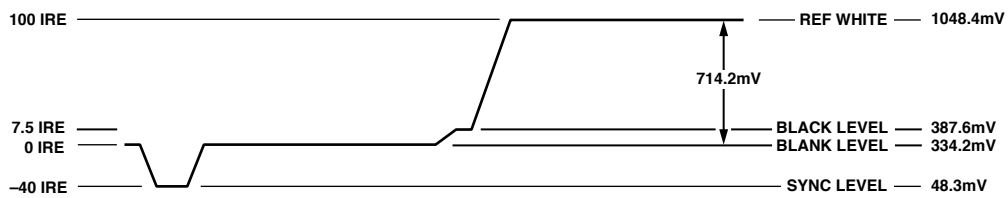

Figure 102. NTSC Luma Video Levels

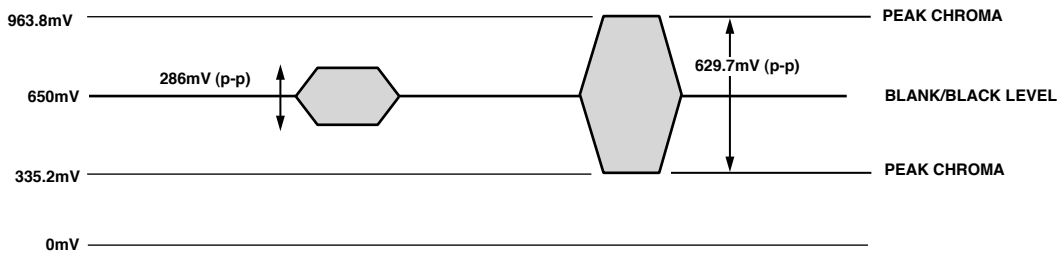

Figure 103. NTSC Chroma Video Levels

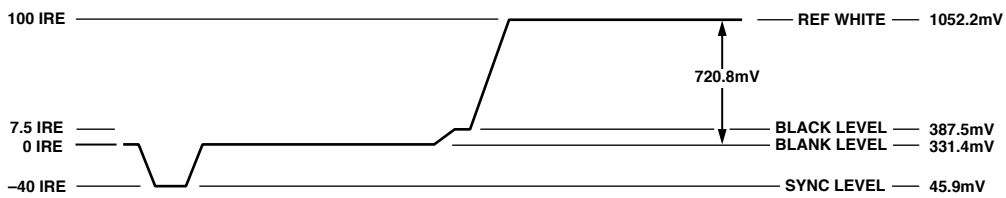

Figure 104. NTSC RGB Video Levels



NTSC WAVEFORMS (WITHOUT PEDESTAL)

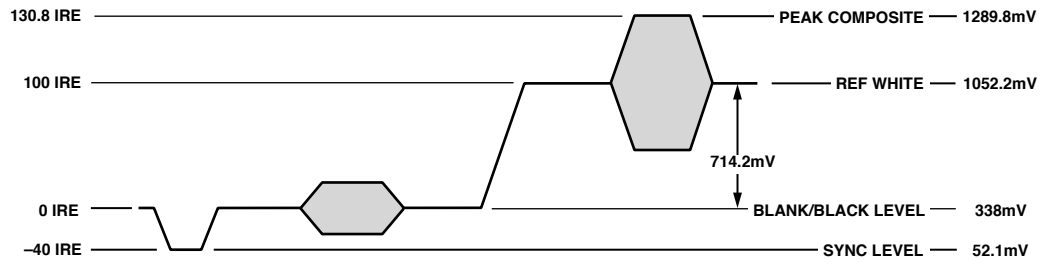

Figure 105. NTSC Composite Video Levels

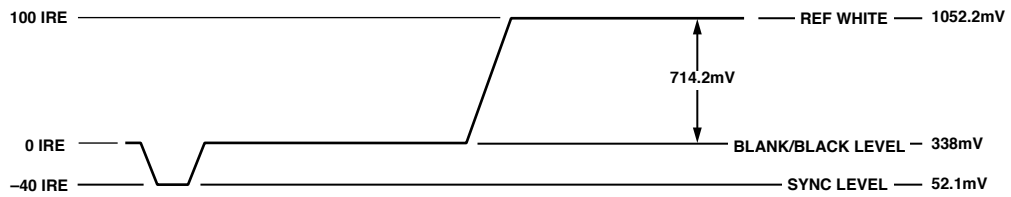

Figure 106. NTSC Luma Video Levels

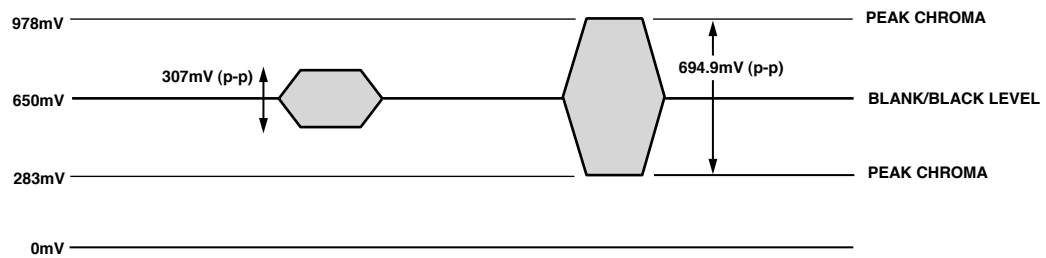

Figure 107. NTSC Chroma Video Levels

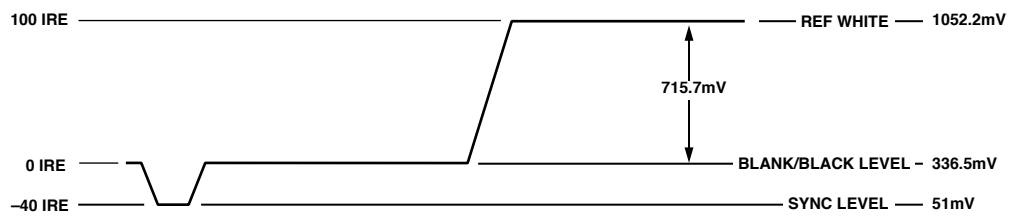

Figure 108. NTSC RGB Video Levels

## PAL WAVEFORMS

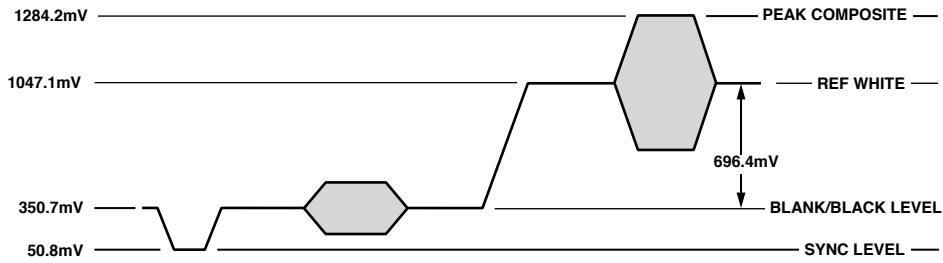

Figure 109. PAL Composite Video Levels

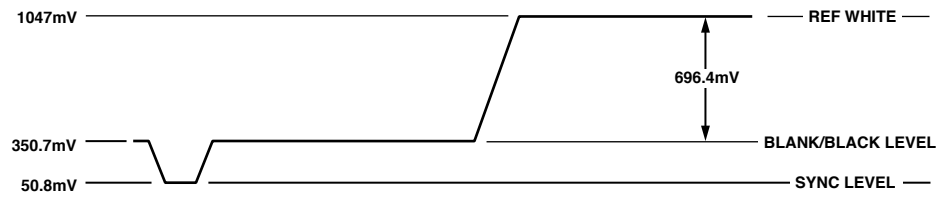

Figure 110. PAL Luma Video Levels

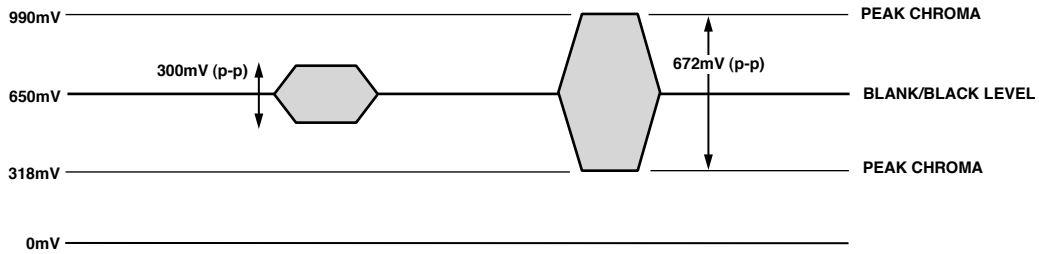

Figure 111. PAL Chroma Video Levels

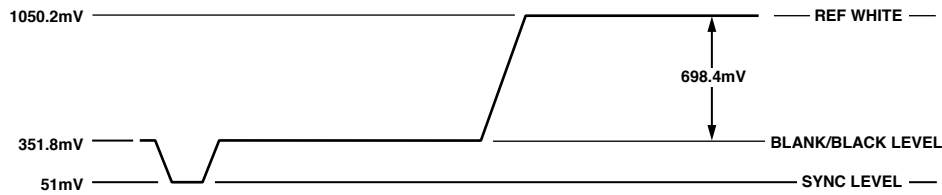

Figure 112. PAL RGB Video Levels

UV WAVEFORMS

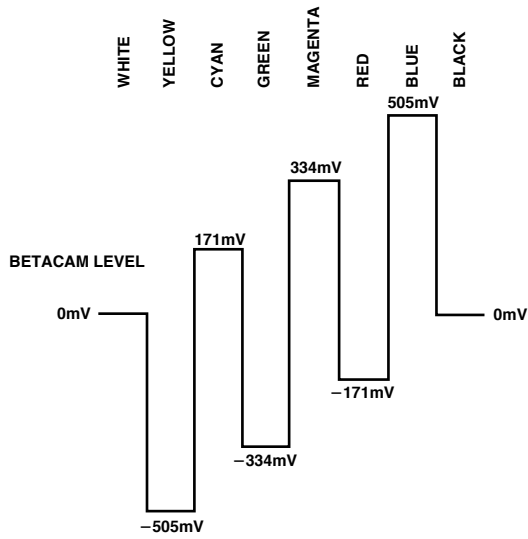

Figure 113. NTSC 100% Color Bars, No Pedestal U Levels

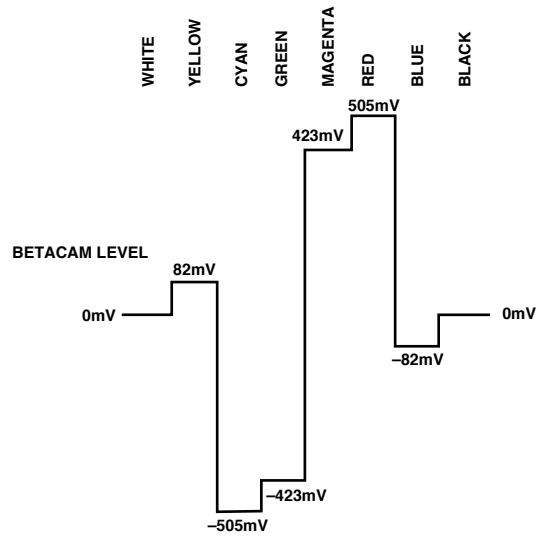

Figure 116. NTSC 100% Color Bars, No Pedestal V Levels

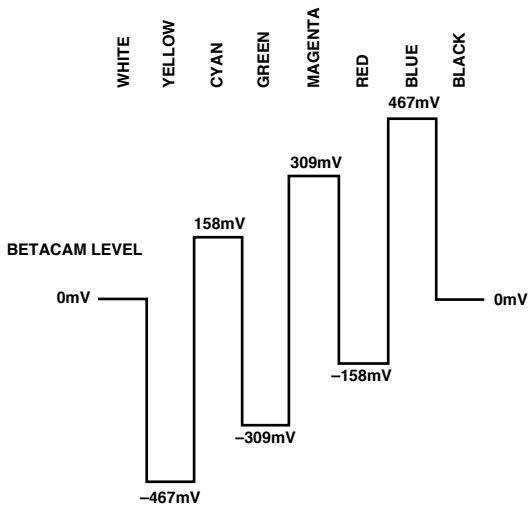

Figure 114. NTSC 100% Color Bars with Pedestal U Levels

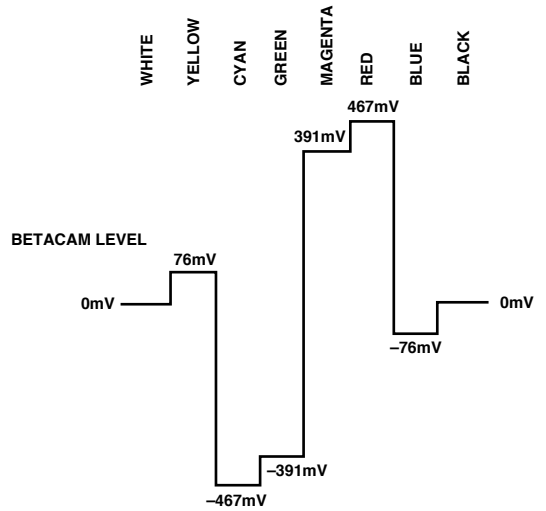

Figure 117. NTSC 100% Color Bars with Pedestal V Levels

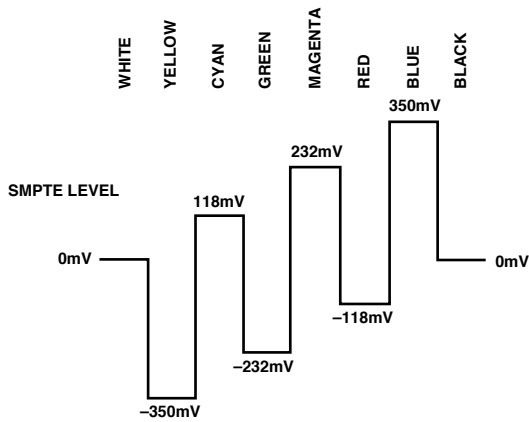

Figure 115. PAL 100% Color Bars U Levels

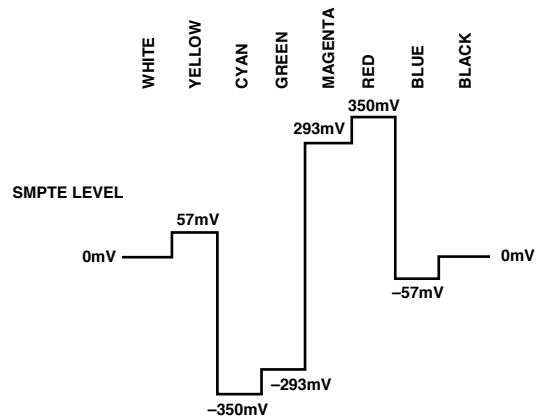

Figure 118. PAL 100% Color Bars V Levels

OUTPUT WAVEFORMS

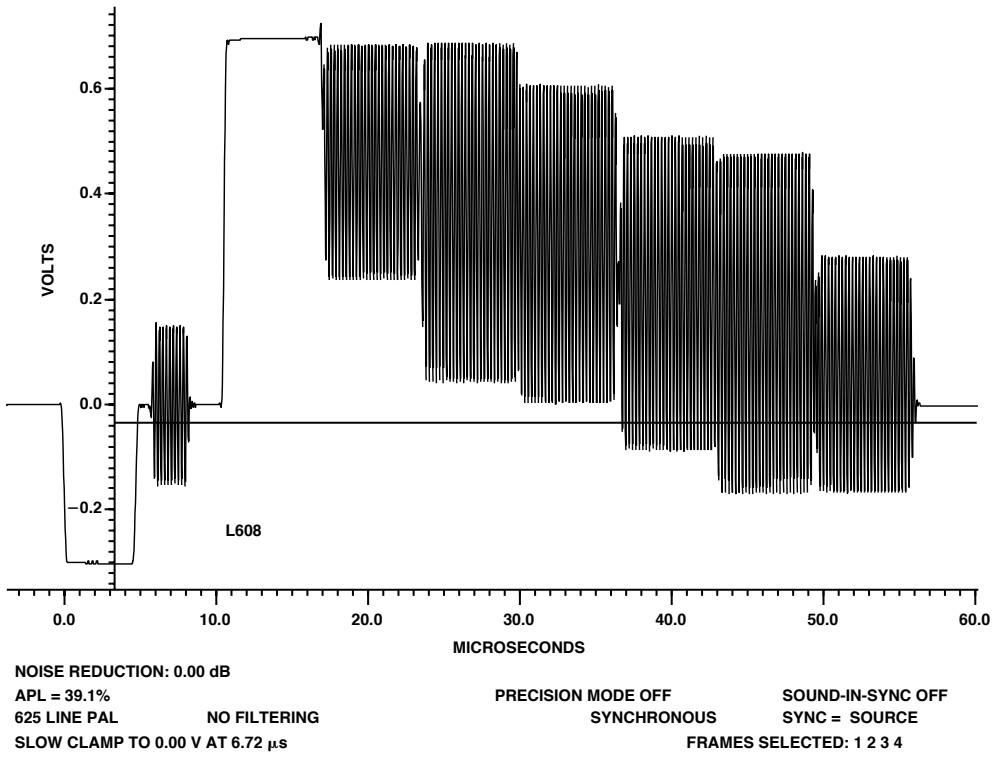

Figure 119. 100/0/75/0 PAL Color Bars

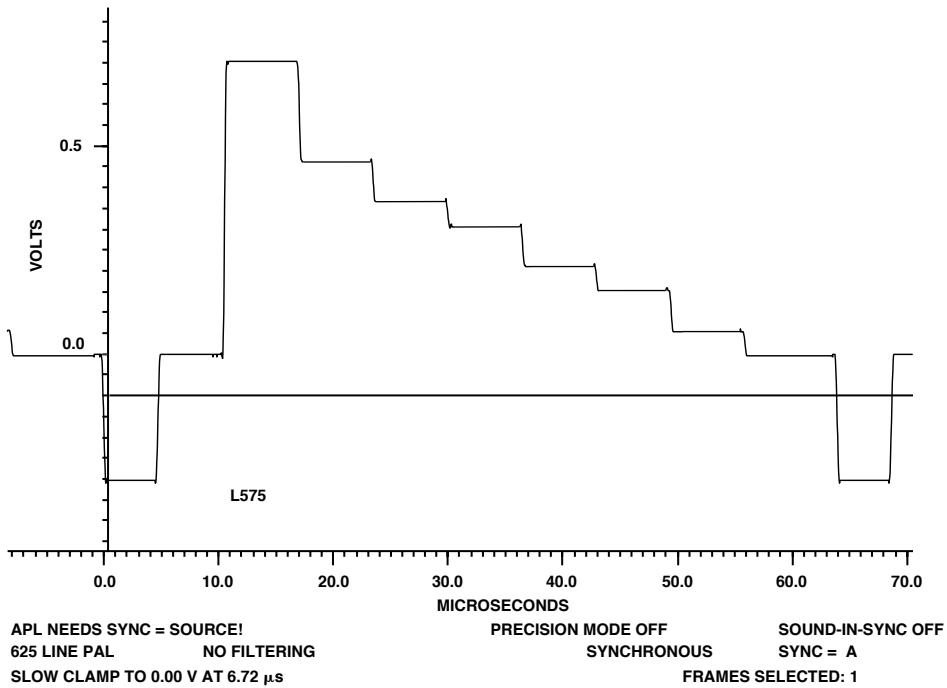

Figure 120. 100/0/75/0 PAL Color Bars Luminance

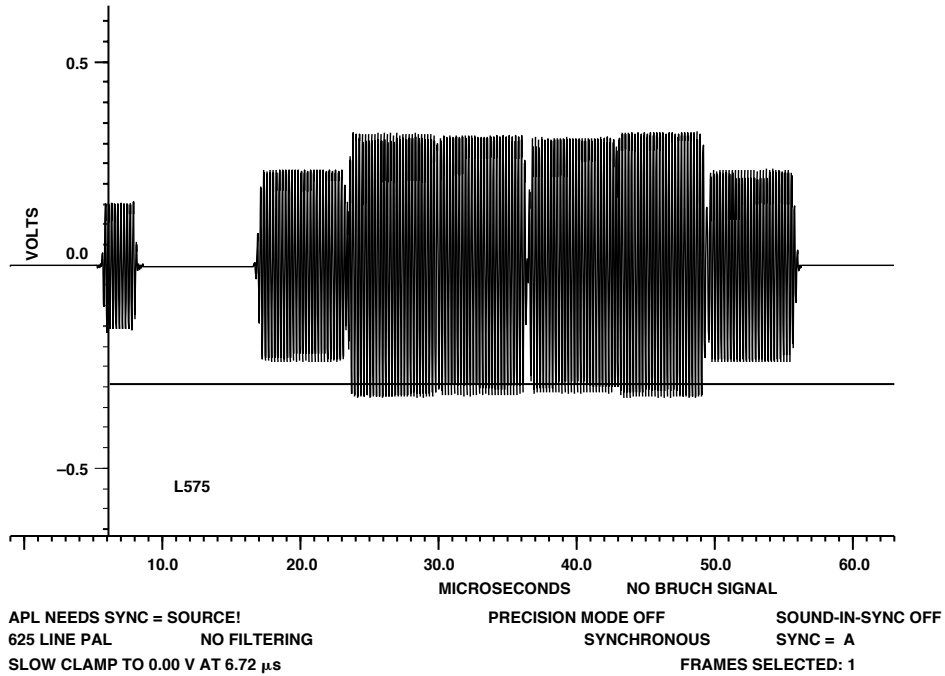

Figure 121. 100/0/75/0 PAL Color Bars Chrominance

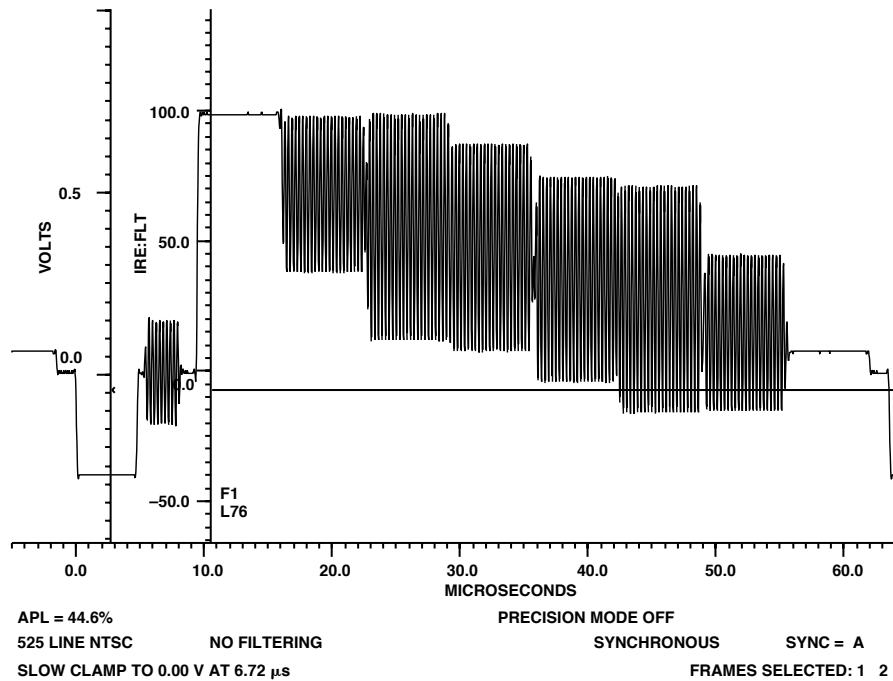

Figure 122. 100/7.5/75/7.5 NTSC Color Bars

# ADV7190/ADV7191

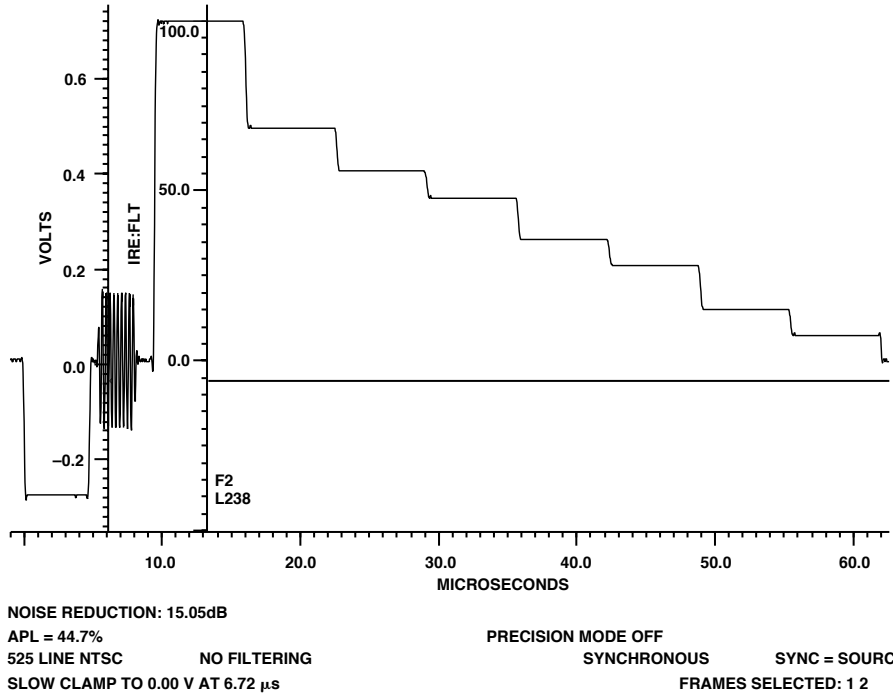

Figure 123. 100/7.5/75/7.5 NTSC Color Bars Luminance

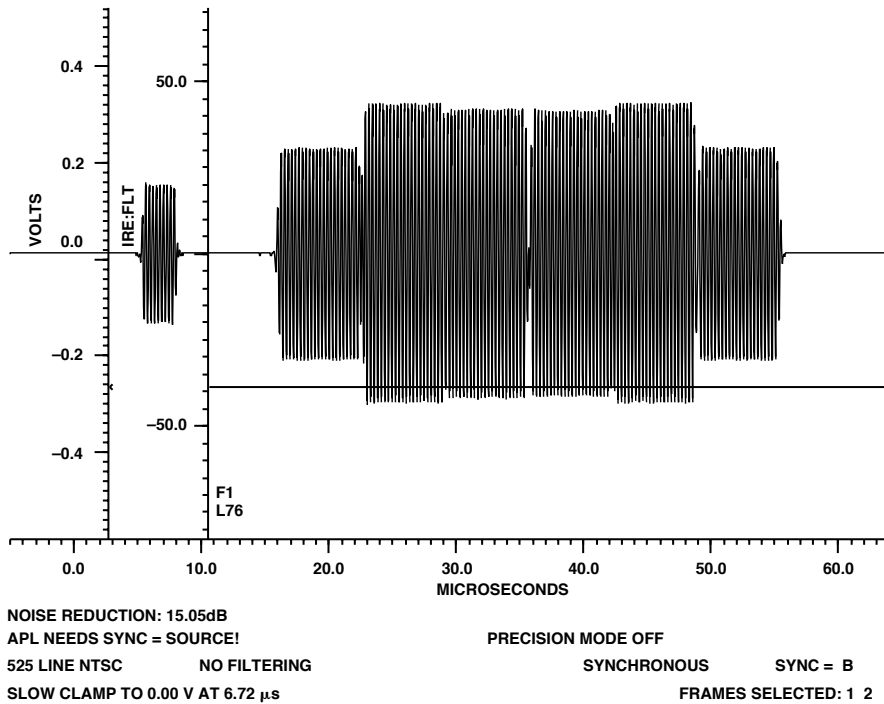

Figure 124. 100/7.5/75/7.5 NTSC Color Bars Chrominance

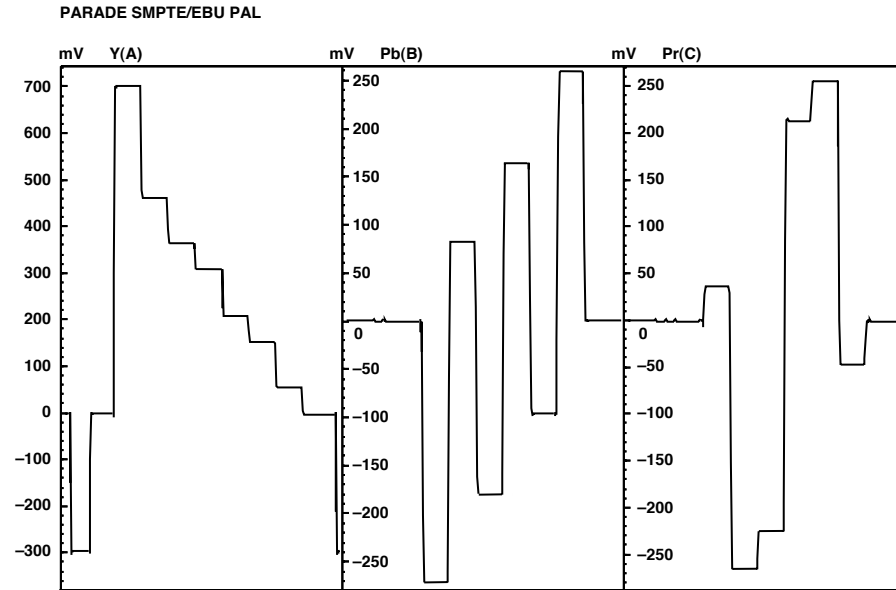

Figure 125. PAL YUV Parade Plot

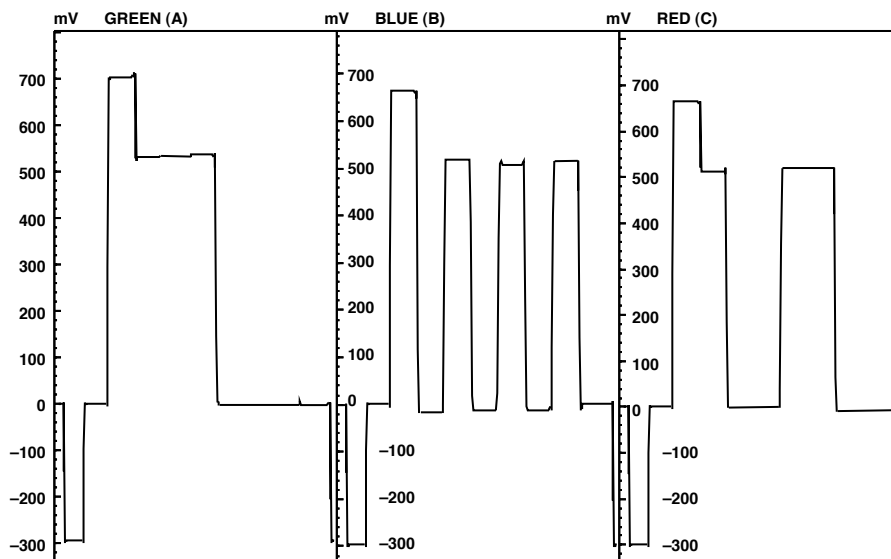

Figure 126. PAL RGB Waveforms

## VIDEO MEASUREMENT PLOTS

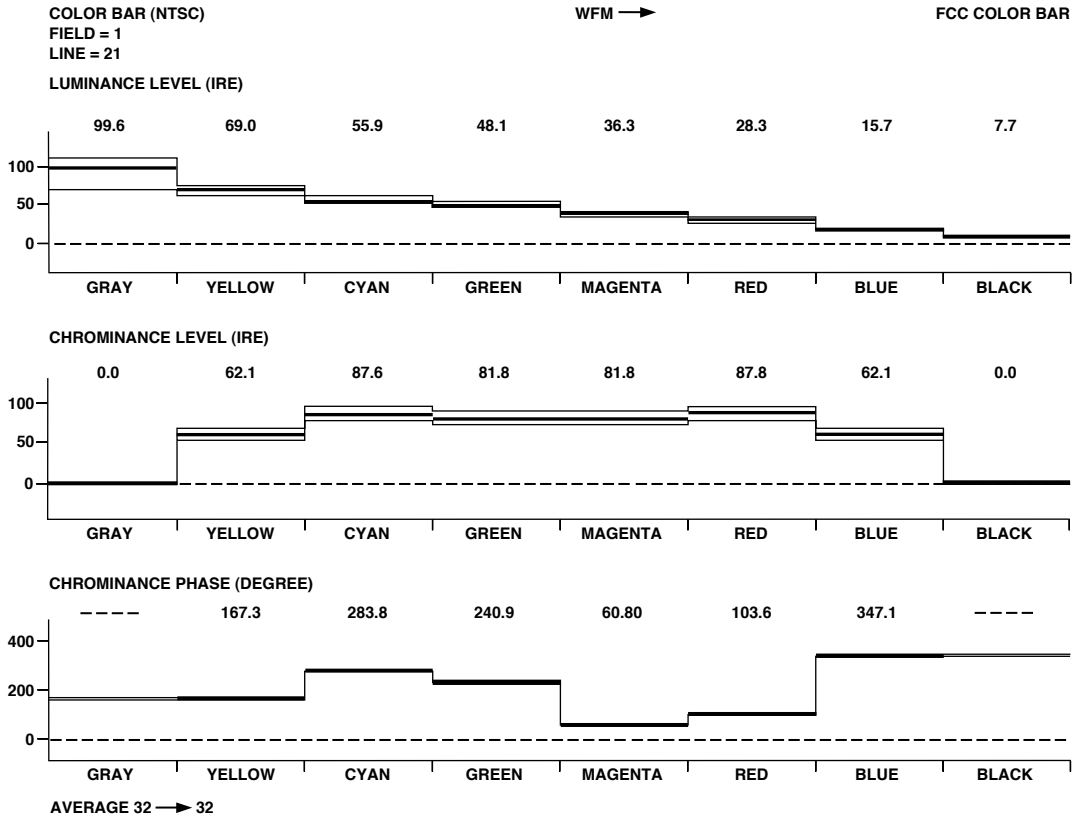

Figure 127. NTSC Color Bar Measurement

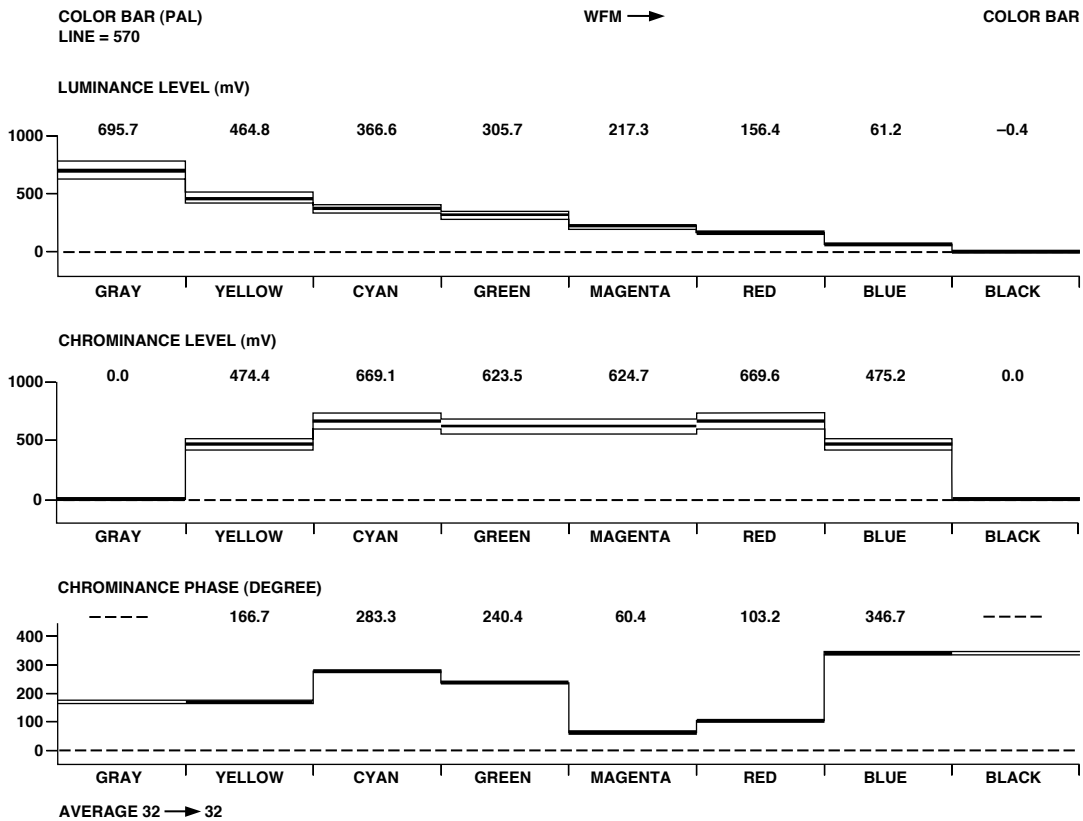

Figure 128. PAL Color Bar Measurement



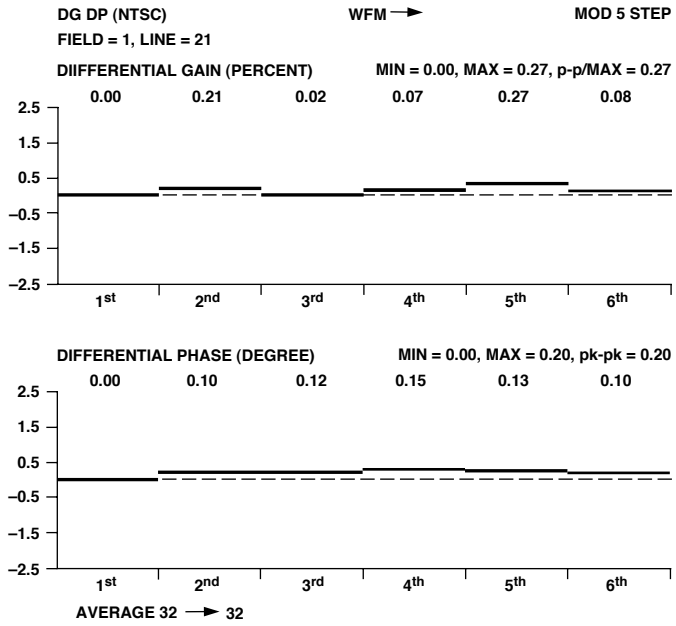

Figure 129. NTSC DG DP Measurement

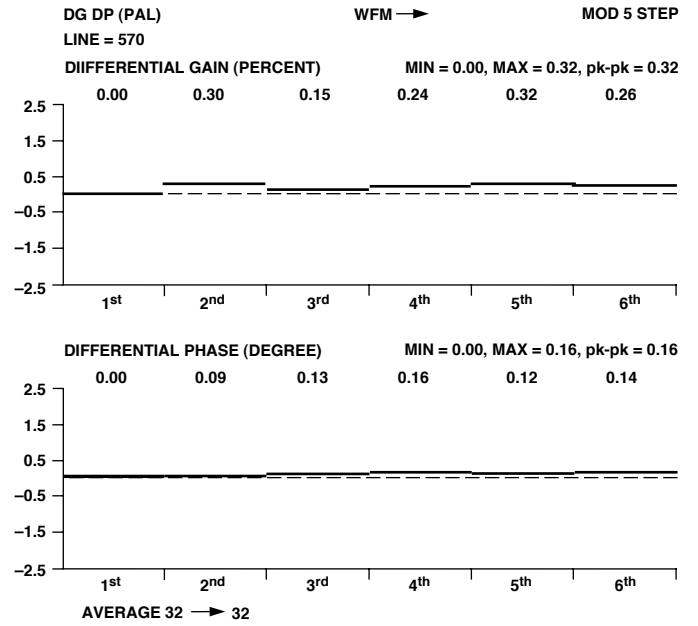

Figure 131. PAL DG DP Measurement

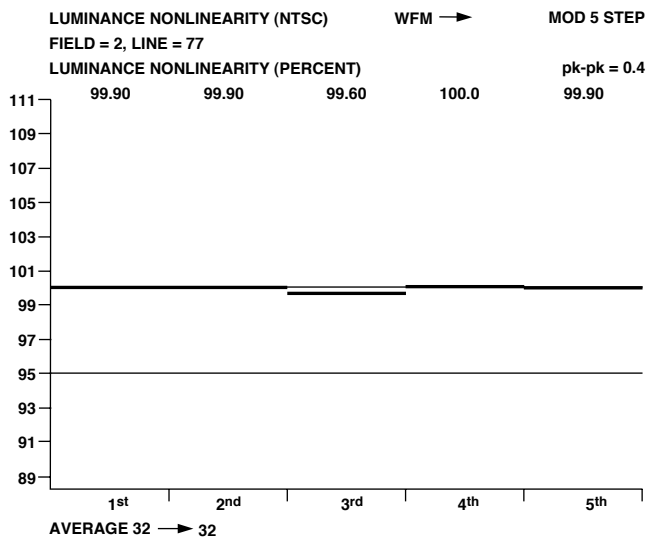

Figure 130. NTSC Luminance Nonlinearity

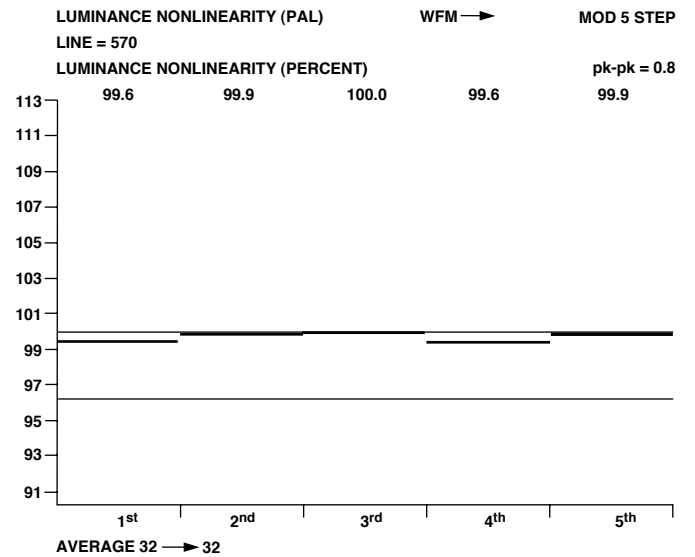

Figure 132. PAL Luminance Nonlinearity

# ADV7190/ADV7191

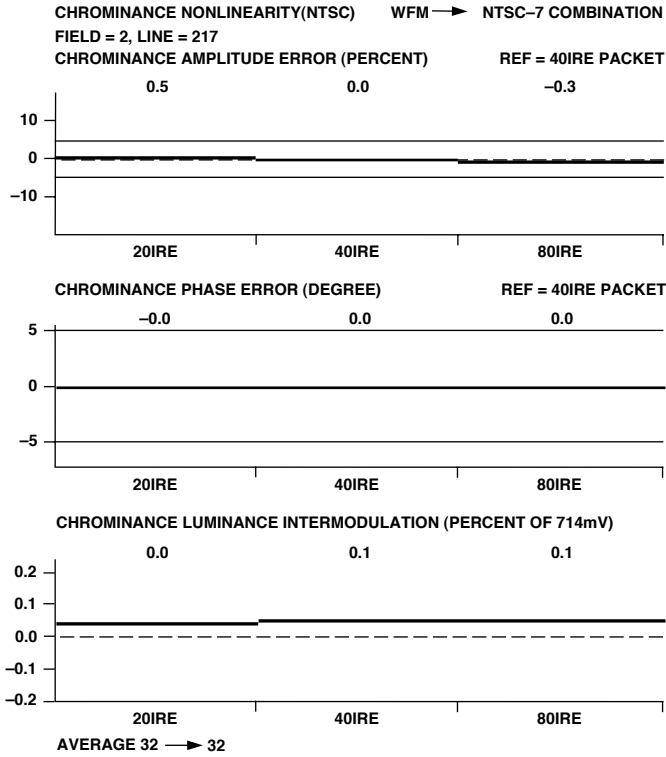

Figure 133. NTSC Chrominance Nonlinearity

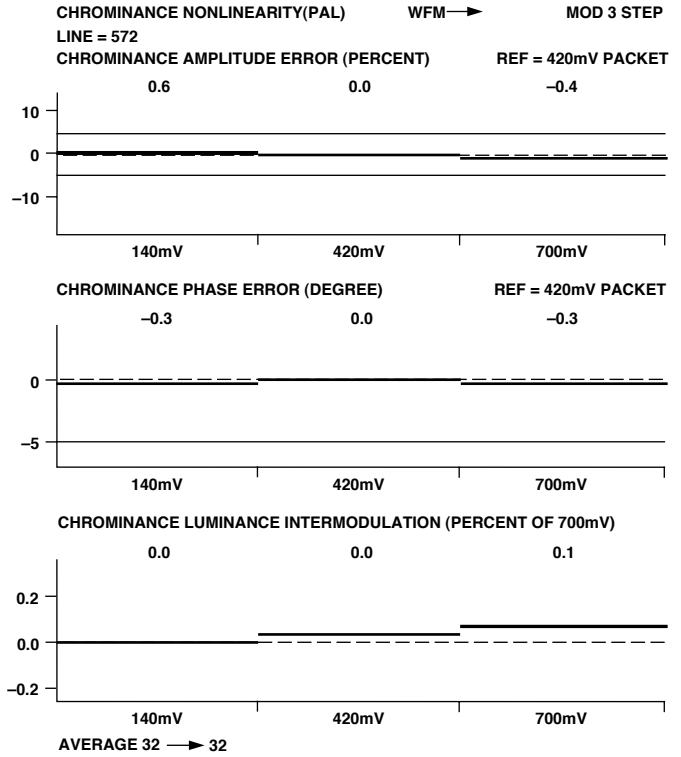

Figure 135. PAL Chrominance Nonlinearity

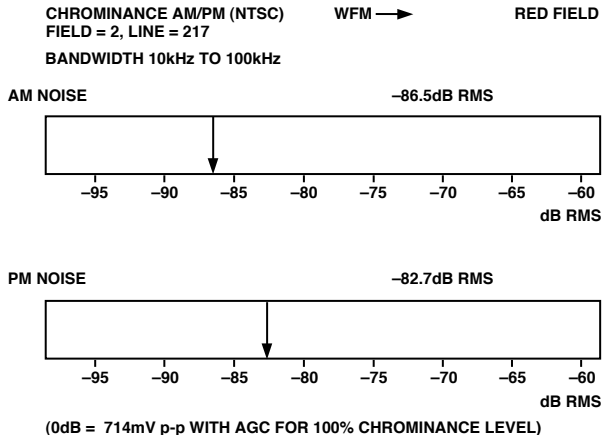

Figure 134. NTSC Chrominance AM/PM

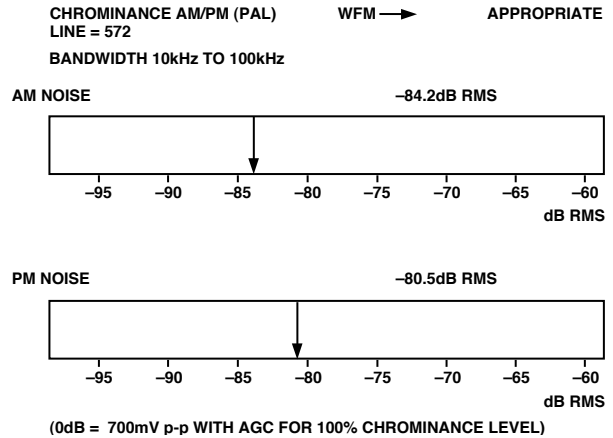

Figure 136. PAL Chrominance AM/PM

NOISE SPECTRUM (NTSC)      WFM →      PEDESTAL  
 FIELD = 2, LINE = 223  
 AMPLITUDE (0dB = 714mV p-p)      NOISE LEVEL = -79.7dB RMS  
 BANDWIDTH 10kHz TO FULL

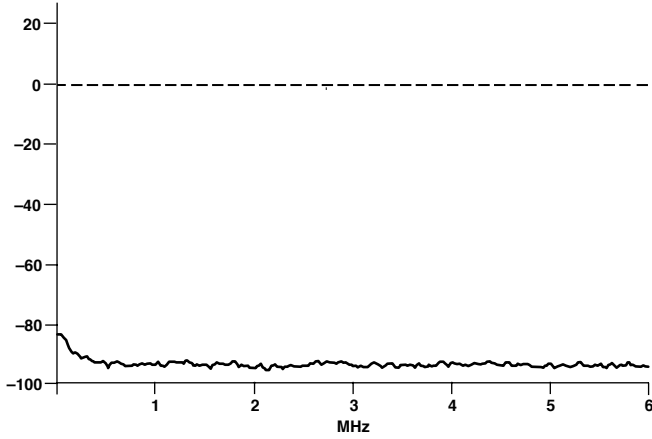

Figure 137. NTSC Noise Spectrum: Pedestal

NOISE SPECTRUM (PAL)      WFM →      PEDESTAL  
 LINE = 511  
 AMPLITUDE (0dB = 714mV p-p)      NOISE LEVEL = -79.1dB RMS  
 BANDWIDTH 10kHz TO FULL

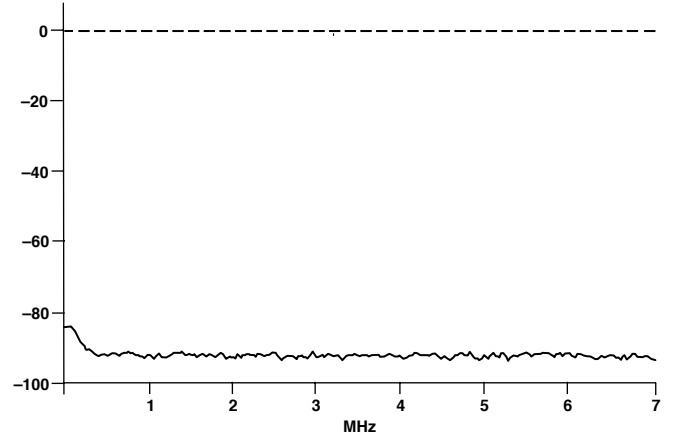

Figure 139. PAL Noise Spectrum: Pedestal

NOISE SPECTRUM (NTSC)      WFM →      RAMP  
 FIELD = 2, LINE = 217  
 AMPLITUDE (0dB = 714mV p-p)      NOISE LEVEL = -63.1dB RMS  
 BANDWIDTH 100kHz TO FULL (TILT NULL)

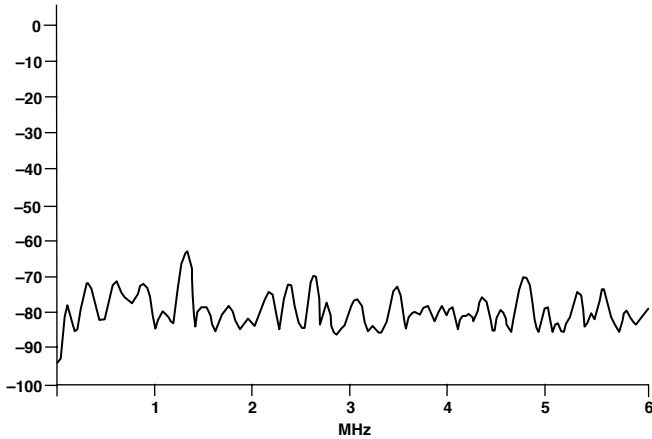

Figure 138. NTSC Noise Spectrum: Ramp

NOISE SPECTRUM (PAL)      WFM →      RAMP  
 LINE = 572  
 AMPLITUDE (0dB = 700mV p-p)      NOISE LEVEL = -62.3dB RMS  
 BANDWIDTH 100kHz TO FULL (TILT NULL)

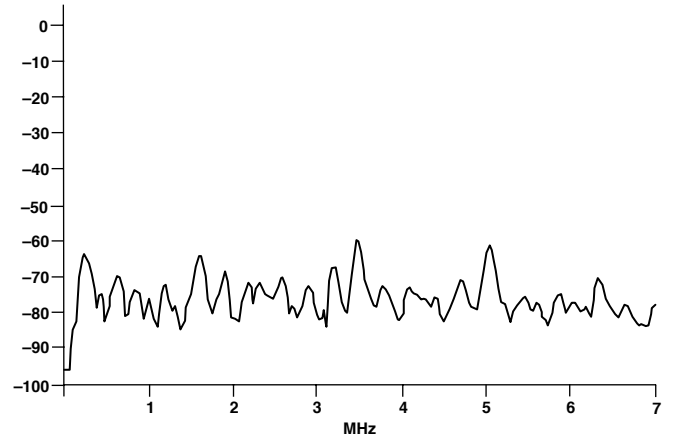

Figure 140. PAL Noise Spectrum: Ramp

APPENDIX 10  
VECTOR PLOTS

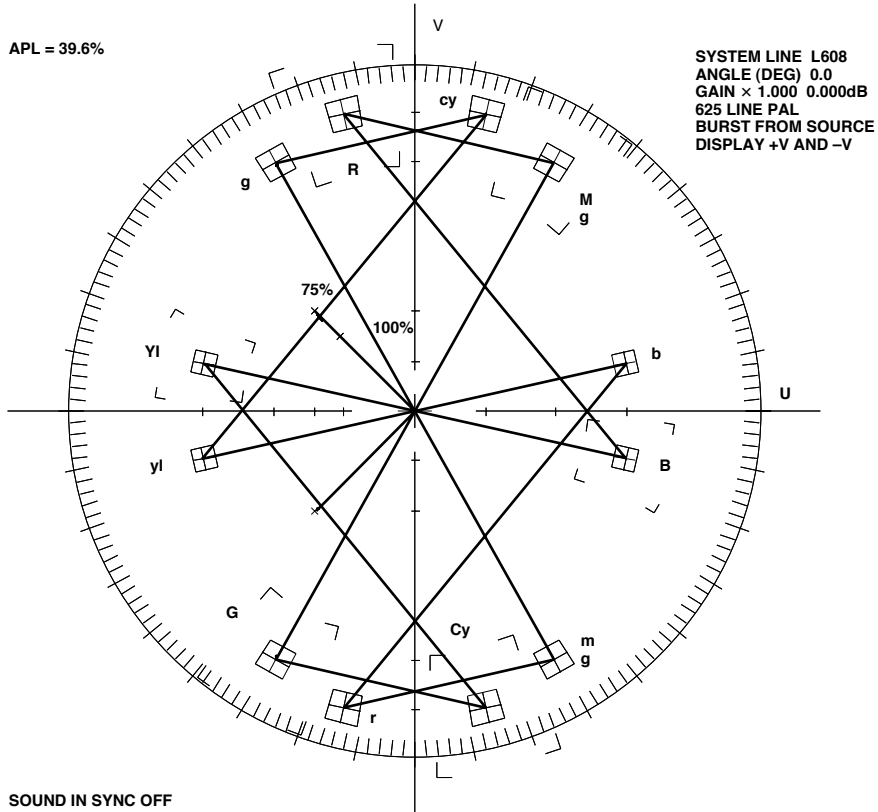

Figure 141. PAL Vector Plot

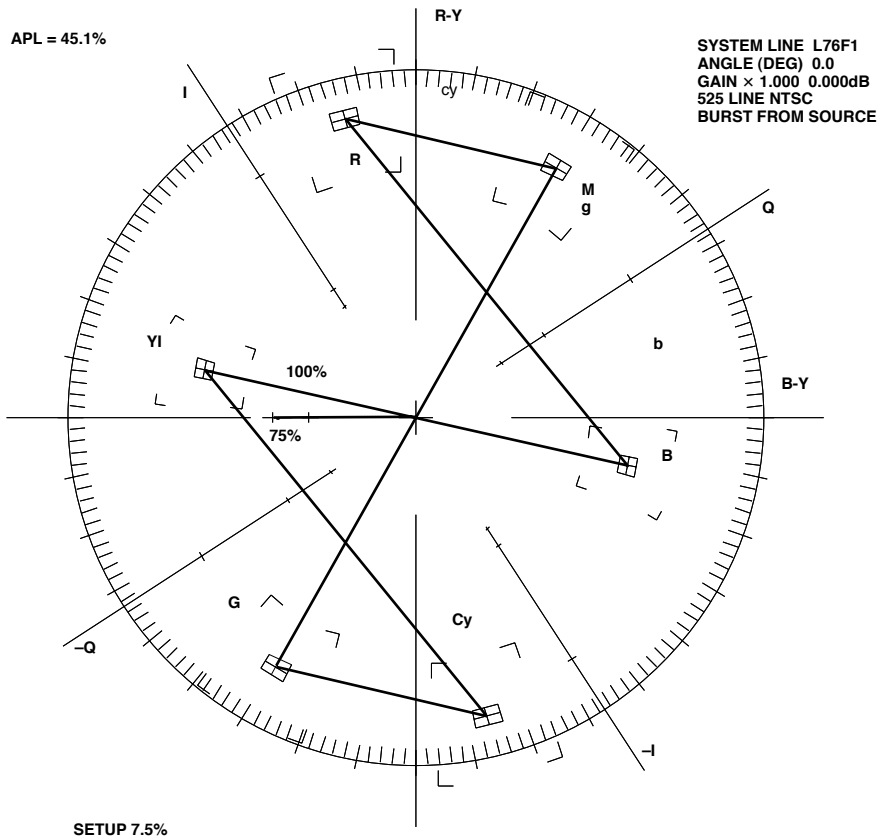
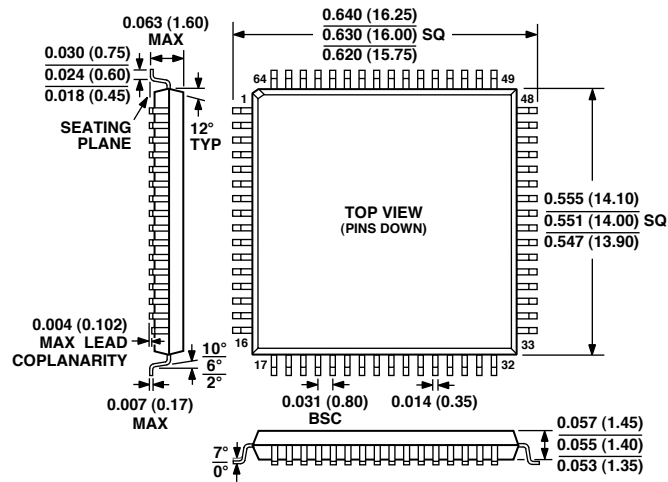

Figure 142. NTSC Vector Plot

OUTLINE DIMENSIONS

Dimensions shown in inches and (mm).

64-Lead Quad Flatpack [LQFP]  
(ST-64)



# ADV7190/ADV7191

## Revision History

Location	Page
5/02—Data Sheet changed from REV. A to REV. B.	
Added Figure 46b .....	27
Changes to Color Bar Control (MR46) section .....	31



