



# 2.5 V to 5.5 V, 500 $\mu$ A, Quad Voltage Output 8-/10-/12-Bit DACs in 10-Lead MSOP

## AD5304/AD5314/AD5324\*

### FEATURES

**AD5304:** 4 Buffered 8-Bit DACs in 10-Lead MSOP  
A Version:  $\pm 1$  LSB INL, B Version:  $\pm 0.625$  LSB INL  
**AD5314:** 4 Buffered 10-Bit DACs in 10-Lead MSOP  
A Version:  $\pm 4$  LSB INL, B Version:  $\pm 2.5$  LSB INL  
**AD5324:** 4 Buffered 12-Bit DACs in 10-Lead MSOP  
A Version:  $\pm 16$  LSB INL, B Version:  $\pm 10$  LSB INL  
**Low Power Operation:** 500  $\mu$ A @ 3 V, 600  $\mu$ A @ 5 V  
**2.5 V to 5.5 V Power Supply**  
**Guaranteed Monotonic by Design over All Codes**  
**Power-Down to 80 nA @ 3 V, 200 nA @ 5 V**  
**Double-Buffered Input Logic**  
**Output Range: 0 V to  $V_{REF}$**   
**Power-On Reset to 0 V**  
**Simultaneous Update of Outputs ( $\overline{LDAC}$  Function)**  
**Low Power, SPI<sup>®</sup>, QSPI<sup>™</sup>, MICROWIRE<sup>™</sup>, and  
DSP Compatible 3-Wire Serial Interface**  
**On-Chip Rail-to-Rail Output Buffer Amplifiers**  
**Temperature Range  $-40^{\circ}\text{C}$  to  $+105^{\circ}\text{C}$**

### APPLICATIONS

Portable Battery-Powered Instruments  
Digital Gain and Offset Adjustment  
Programmable Voltage and Current Sources  
Programmable Attenuators  
Industrial Process Control

### GENERAL DESCRIPTION

The AD5304/AD5314/AD5324 are quad 8-, 10-, and 12-bit buffered voltage output DACs in a 10-lead MSOP that operate from a single 2.5 V to 5.5 V supply, consuming 500  $\mu$ A at 3 V. Their on-chip output amplifiers allow rail-to-rail output swing to be achieved with a slew rate of 0.7 V/ $\mu$ s. A 3-wire serial interface is used, which operates at clock rates up to 30 MHz and is compatible with standard SPI, QSPI, MICROWIRE, and DSP interface standards.

The references for the four DACs are derived from one reference pin. The outputs of all DACs may be updated simultaneously using the software  $\overline{LDAC}$  function. The parts incorporate a power-on reset circuit, which ensures that the DAC outputs power up to 0 V and remain there until a valid write takes place to the device. The parts contain a power-down feature that reduces the current consumption of the device to 200 nA @ 5 V (80 nA @ 3 V).

The low power consumption of these parts in normal operation makes them ideally suited to portable battery-operated equipment. The power consumption is 3 mW at 5 V, 1.5 mW at 3 V, reducing to 1  $\mu$ W in power-down mode.

### FUNCTIONAL BLOCK DIAGRAM

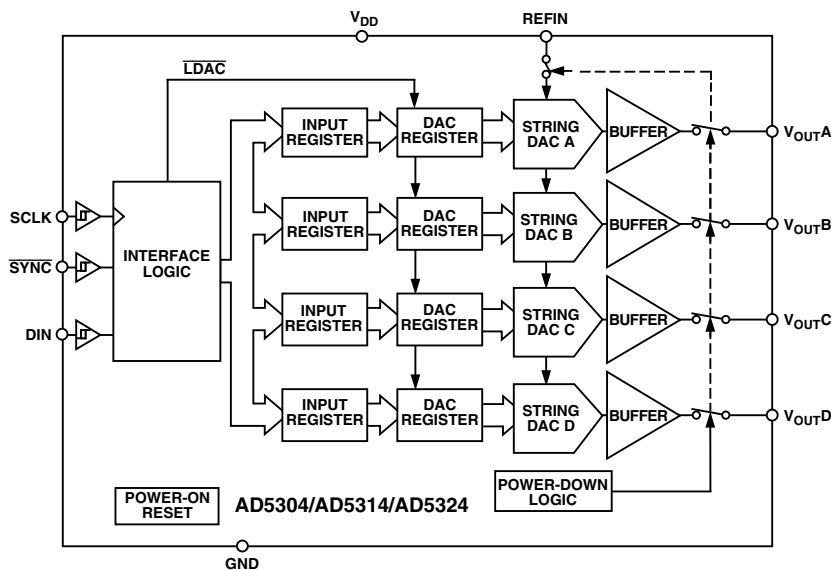

\*Protected by U.S. Patent No. 5,969,657; other patents pending.

### REV. D

Information furnished by Analog Devices is believed to be accurate and reliable. However, no responsibility is assumed by Analog Devices for its use, nor for any infringements of patents or other rights of third parties that may result from its use. No license is granted by implication or otherwise under any patent or patent rights of Analog Devices. Trademarks and registered trademarks are the property of their respective companies.

One Technology Way, P.O. Box 9106, Norwood, MA 02062-9106, U.S.A.  
Tel: 781/329-4700 [www.analog.com](http://www.analog.com)  
Fax: 781/326-8703 © 2003 Analog Devices, Inc. All rights reserved.

# AD5304/AD5314/AD5324—SPECIFICATIONS ( $V_{DD} = 2.5\text{ V to }5.5\text{ V}$ ; $V_{REF} = 2\text{ V}$ ; $R_L = 2\text{ k}\Omega$ to $\text{GND}$ ; $C_L = 200\text{ pF}$ to $\text{GND}$ ; all specifications $T_{MIN}$ to $T_{MAX}$ , unless otherwise noted.)

Parameter <sup>1</sup>	A Version <sup>2</sup>			B Version <sup>2</sup>			Unit	Conditions/Comments
	Min	Typ	Max	Min	Typ	Max		
<b>DC PERFORMANCE<sup>3,4</sup></b>								
AD5304								
Resolution		8		8			Bits	Guaranteed Monotonic by Design over All Codes
Relative Accuracy		$\pm 0.15$	$\pm 1$	$\pm 0.15$	$\pm 0.625$		LSB	
Differential Nonlinearity		$\pm 0.02$	$\pm 0.25$	$\pm 0.02$	$\pm 0.25$		LSB	
AD5314								
Resolution		10		10			Bits	Guaranteed Monotonic by Design over All Codes
Relative Accuracy		$\pm 0.5$	$\pm 4$	$\pm 0.5$	$\pm 2.5$		LSB	
Differential Nonlinearity		$\pm 0.05$	$\pm 0.5$	$\pm 0.05$	$\pm 0.5$		LSB	
AD5324								
Resolution		12		12			Bits	Guaranteed Monotonic by Design over All Codes
Relative Accuracy		$\pm 2$	$\pm 16$	$\pm 2$	$\pm 10$		LSB	
Differential Nonlinearity		$\pm 0.2$	$\pm 1$	$\pm 0.2$	$\pm 1$		LSB	
Offset Error		$\pm 0.4$	$\pm 3$	$\pm 0.4$	$\pm 3$		% of FSR	See Figures 2 and 3
Gain Error		$\pm 0.15$	$\pm 1$	$\pm 0.15$	$\pm 1$		% of FSR	See Figures 2 and 3
Lower Deadband		20	60	20	60		mV	Lower deadband exists only if offset error is negative.
Offset Error Drift <sup>5</sup>		-12		-12			ppm of FSR/ $^{\circ}\text{C}$	$\Delta V_{DD} = \pm 10\%$ $R_L = 2\text{ k}\Omega$ to $\text{GND}$ or $V_{DD}$
Gain Error Drift <sup>5</sup>		-5		-5			ppm of FSR/ $^{\circ}\text{C}$	
DC Power Supply Rejection Ratio <sup>5</sup>		-60		-60			dB	
DC Crosstalk <sup>5</sup>		200		200			$\mu\text{V}$	
<b>DAC REFERENCE INPUTS<sup>5</sup></b>								
$V_{REF}$ Input Range	0.25		$V_{DD}$	0.25		$V_{DD}$	V	Normal Operation Power-Down Mode Frequency = 10 kHz
$V_{REF}$ Input Impedance	37	45		37	45		k $\Omega$	
Reference Feedthrough		>10			>10		M $\Omega$	
		-90			-90		dB	
<b>OUTPUT CHARACTERISTICS<sup>5</sup></b>								
Minimum Output Voltage <sup>6</sup>		0.001		0.001			V	This is a measure of the minimum and maximum drive capability of the output amplifier.
Maximum Output Voltage <sup>6</sup>		$V_{DD} - 0.001$		$V_{DD} - 0.001$			V	
DC Output Impedance		0.5		0.5			$\Omega$	$V_{DD} = 5\text{ V}$ $V_{DD} = 3\text{ V}$ Coming out of Power-Down Mode. $V_{DD} = 5\text{ V}$ Coming out of Power-Down Mode. $V_{DD} = 3\text{ V}$
Short Circuit Current		25		25			mA	
		16		16			mA	
Power-Up Time		2.5		2.5			$\mu\text{s}$	
		5		5			$\mu\text{s}$	
<b>LOGIC INPUTS<sup>5</sup></b>								
Input Current			$\pm 1$		$\pm 1$		$\mu\text{A}$	$V_{DD} = 5\text{ V} \pm 10\%$ $V_{DD} = 3\text{ V} \pm 10\%$ $V_{DD} = 2.5\text{ V}$ $V_{DD} = 5\text{ V} \pm 10\%$ $V_{DD} = 3\text{ V} \pm 10\%$ $V_{DD} = 2.5\text{ V}$
$V_{IL}$ Input Low Voltage			0.8		0.8		V	
			0.6		0.6		V	
			0.5		0.5		V	
$V_{IH}$ Input High Voltage	2.4			2.4			V	
	2.1			2.1			V	
	2.0			2.0			V	
Pin Capacitance		3		3			pF	
<b>POWER REQUIREMENTS</b>								
$V_{DD}$	2.5		5.5	2.5		5.5	V	$V_{IH} = V_{DD}$ and $V_{IL} = \text{GND}$ $V_{IH} = V_{DD}$ and $V_{IL} = \text{GND}$ $V_{IH} = V_{DD}$ and $V_{IL} = \text{GND}$ $V_{IH} = V_{DD}$ and $V_{IL} = \text{GND}$
$I_{DD}$ (Normal Mode) <sup>7</sup>								
$V_{DD} = 4.5\text{ V to }5.5\text{ V}$		600	900	600	900		$\mu\text{A}$	
$V_{DD} = 2.5\text{ V to }3.6\text{ V}$		500	700	500	700		$\mu\text{A}$	
$I_{DD}$ (Power-Down Mode)								
$V_{DD} = 4.5\text{ V to }5.5\text{ V}$		0.2	1	.02	1		$\mu\text{A}$	
$V_{DD} = 2.5\text{ V to }3.6\text{ V}$		0.08	1	0.08	1		$\mu\text{A}$	

## NOTES

<sup>1</sup>See the Terminology section.

<sup>2</sup>Temperature range (A, B Version):  $-40^{\circ}\text{C}$  to  $+105^{\circ}\text{C}$ ; typical at  $+25^{\circ}\text{C}$ .

<sup>3</sup>DC specifications tested with the outputs unloaded.

<sup>4</sup>Linearity is tested using a reduced code range: AD5304 (Code 8 to 248); AD5314 (Code 28 to 995); AD5324 (Code 115 to 3981).

<sup>5</sup>Guaranteed by design and characterization, not production tested.

<sup>6</sup>For the amplifier output to reach its minimum voltage, offset error must be negative. For the amplifier output to reach its maximum voltage,  $V_{REF} = V_{DD}$  and offset plus gain error must be positive.

<sup>7</sup> $I_{DD}$  specification is valid for all DAC codes. Interface inactive. All DACs active. Load currents excluded.

Specifications subject to change without notice.

## AC CHARACTERISTICS<sup>1</sup> ( $V_{DD} = 2.5\text{ V to }5.5\text{ V}$ ; $R_L = 2\text{ k}\Omega\text{ to GND}$ ; $C_L = 200\text{ pF to GND}$ ; all specifications $T_{MIN}$ to $T_{MAX}$ , unless otherwise noted.)

Parameter <sup>2</sup>	A, B Version <sup>3</sup>			Unit	Conditions/Comments
	Min	Typ	Max		
Output Voltage Settling Time					$V_{REF} = V_{DD} = 5\text{ V}$
AD5304		6	8	$\mu\text{s}$	1/4 Scale to 3/4 Scale Change (0x40 to 0xC0)
AD5314		7	9	$\mu\text{s}$	1/4 Scale to 3/4 Scale Change (0x100 to 0x300)
AD5324		8	10	$\mu\text{s}$	1/4 Scale to 3/4 Scale Change (0x400 to 0xC00)
Slew Rate		0.7		V/ $\mu\text{s}$	
Major-Code Transition Glitch Energy		12		nV-s	1 LSB Change around Major Carry
Digital Feedthrough		1		nV-s	
Digital Crosstalk		1		nV-s	
DAC-to-DAC Crosstalk		3		nV-s	
Multiplying Bandwidth		200		kHz	$V_{REF} = 2\text{ V} \pm 0.1\text{ V p-p}$
Total Harmonic Distortion		-70		dB	$V_{REF} = 2.5\text{ V} \pm 0.1\text{ V p-p}$ . Frequency = 10 kHz

### NOTES

<sup>1</sup>Guaranteed by design and characterization, not production tested.

<sup>2</sup>See the Terminology section.

<sup>3</sup>Temperature range (A, B Version):  $-40^\circ\text{C to }+105^\circ\text{C}$ ; typical at  $+25^\circ\text{C}$ .

Specifications subject to change without notice.

## TIMING CHARACTERISTICS<sup>1, 2, 3</sup> ( $V_{DD} = 2.5\text{ V to }5.5\text{ V}$ . All specifications $T_{MIN}$ to $T_{MAX}$ , unless otherwise noted.)

Parameter	Limit at $T_{MIN}, T_{MAX}$		Unit	Conditions/Comments
	$V_{DD} = 2.5\text{ V to }3.6\text{ V}$	$V_{DD} = 3.6\text{ V to }5.5\text{ V}$		
$t_1$	40	33	ns min	SCLK Cycle Time
$t_2$	16	13	ns min	SCLK High Time
$t_3$	16	13	ns min	SCLK Low Time
$t_4$	16	13	ns min	$\overline{\text{SYNC}}$ to SCLK Falling Edge Setup Time
$t_5$	5	5	ns min	Data Setup Time
$t_6$	4.5	4.5	ns min	Data Hold Time
$t_7$	0	0	ns min	SCLK Falling Edge to $\overline{\text{SYNC}}$ Rising Edge
$t_8$	80	33	ns min	Minimum $\overline{\text{SYNC}}$ High Time

### NOTES

<sup>1</sup>Guaranteed by design and characterization, not production tested.

<sup>2</sup>All input signals are specified with  $t_r = t_f = 5\text{ ns}$  (10% to 90% of  $V_{DD}$ ) and timed from a voltage level of  $(V_{IL} + V_{IH})/2$ .

<sup>3</sup>See Figure 1.

Specifications subject to change without notice.

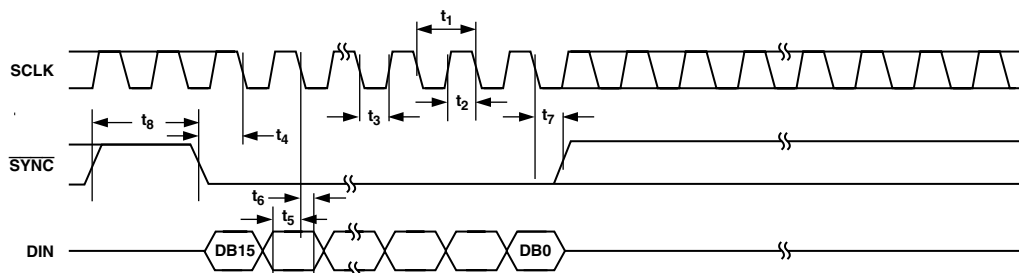

Figure 1. Serial Interface Timing Diagram

# AD5304/AD5314/AD5324

## ABSOLUTE MAXIMUM RATINGS<sup>1, 2</sup>

(T<sub>A</sub> = 25°C, unless otherwise noted.)

V <sub>DD</sub> to GND	-0.3 V to +7 V
Digital Input Voltage to GND	-0.3 V to V <sub>DD</sub> + 0.3 V
Reference Input Voltage to GND	-0.3 V to V <sub>DD</sub> + 0.3 V
V <sub>OUTA-D</sub> to GND	-0.3 V to V <sub>DD</sub> + 0.3 V
Operating Temperature Range	
Industrial (A, B Version)	-40°C to +105°C
Storage Temperature Range	-65°C to +150°C
Junction Temperature (T <sub>J</sub> max)	150°C

## 10-Lead MSOP

Power Dissipation	(T <sub>J</sub> max - T <sub>A</sub> )/θ <sub>JA</sub>
θ <sub>JA</sub> Thermal Impedance	206°C/W
θ <sub>JC</sub> Thermal Impedance	44°C/W
Reflow Soldering	
Peak Temperature	220°C
Time at Peak Temperature	10 sec to 40 sec

## NOTES

<sup>1</sup>Stresses above those listed under Absolute Maximum Ratings may cause permanent damage to the device. This is a stress rating only; functional operation of the device at these or any other conditions above those listed in the operational sections of this specification is not implied. Exposure to absolute maximum rating conditions for extended periods may affect device reliability.

<sup>2</sup>Transient currents of up to 100 mA will not cause SCR latch-up.

## ORDERING GUIDE

Model	Temperature Range	Package Description	Package Option	Branding
AD5304ARM	-40°C to +105°C	10-Lead MSOP	RM-10	DBA
AD5304ARM-REEL7	-40°C to +105°C	10-Lead MSOP	RM-10	DBA
AD5314ARM	-40°C to +105°C	10-Lead MSOP	RM-10	DCA
AD5314ARM-REEL7	-40°C to +105°C	10-Lead MSOP	RM-10	DCA
AD5324ARM	-40°C to +105°C	10-Lead MSOP	RM-10	DDA
AD5324ARM-REEL7	-40°C to +105°C	10-Lead MSOP	RM-10	DDA
AD5304BRM	-40°C to +105°C	10-Lead MSOP	RM-10	DBB
AD5304BRM-REEL	-40°C to +105°C	10-Lead MSOP	RM-10	DBB
AD5304BRM-REEL7	-40°C to +105°C	10-Lead MSOP	RM-10	DBB
AD5304BRMZ-REEL*	-40°C to +105°C	10-Lead MSOP	RM-10	DBB
AD5314BRM	-40°C to +105°C	10-Lead MSOP	RM-10	DCB
AD5314BRM-REEL	-40°C to +105°C	10-Lead MSOP	RM-10	DCB
AD5314BRM-REEL7	-40°C to +105°C	10-Lead MSOP	RM-10	DCB
AD5324BRM	-40°C to +105°C	10-Lead MSOP	RM-10	DDB
AD5324BRM-REEL	-40°C to +105°C	10-Lead MSOP	RM-10	DDB
AD5324BRM-REEL7	-40°C to +105°C	10-Lead MSOP	RM-10	DDB

\*A pb (lead) free product

## CAUTION

ESD (electrostatic discharge) sensitive device. Electrostatic charges as high as 4000 V readily accumulate on the human body and test equipment and can discharge without detection. Although the AD5304/AD5314/AD5324 feature proprietary ESD protection circuitry, permanent damage may occur on devices subjected to high energy electrostatic discharges. Therefore, proper ESD precautions are recommended to avoid performance degradation or loss of functionality.



PIN CONFIGURATION

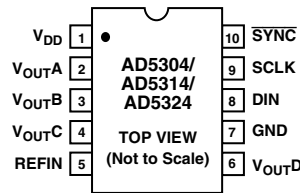

PIN FUNCTION DESCRIPTIONS

Pin No.	Mnemonic	Function
1	V <sub>DD</sub>	Power Supply Input. These parts can be operated from 2.5 V to 5.5 V and the supply should be decoupled to GND.
2	V <sub>OUTA</sub>	Buffered Analog Output Voltage from DAC A. The output amplifier has rail-to-rail operation.
3	V <sub>OUTB</sub>	Buffered Analog Output Voltage from DAC B. The output amplifier has rail-to-rail operation.
4	V <sub>OUTC</sub>	Buffered Analog Output Voltage from DAC C. The output amplifier has rail-to-rail operation.
5	REFIN	Reference Input Pin for All Four DACs. It has an input range from 0.25 V to V <sub>DD</sub> .
6	V <sub>OUTD</sub>	Buffered Analog Output Voltage from DAC D. The output amplifier has rail-to-rail operation.
7	GND	Ground Reference Point for All Circuitry on the Part.
8	DIN	Serial Data Input. This device has a 16-bit shift register. Data is clocked into the register on the falling edge of the serial clock input. The DIN input buffer is powered down after each write cycle.
9	SCLK	Serial Clock Input. Data is clocked into the input shift register on the falling edge of the serial clock input. Data can be transferred at clock speeds up to 30 MHz. The SCLK input buffer is powered down after each write cycle.
10	$\overline{\text{SYNC}}$	Active Low Control Input. This is the frame synchronization signal for the input data. When $\overline{\text{SYNC}}$ goes low, it enables the input shift register and data is transferred in on the falling edges of the following 16 clocks. If $\overline{\text{SYNC}}$ is taken high before the 16th falling edge of SCLK, the rising edge of $\overline{\text{SYNC}}$ acts as an interrupt and the write sequence is ignored by the device.

# AD5304/AD5314/AD5324

## TERMINOLOGY

### Relative Accuracy

For the DAC, relative accuracy or integral nonlinearity (INL) is a measure of the maximum deviation, in LSB, from a straight line passing through the endpoints of the DAC transfer function. Typical INL versus code plots can be seen in TPCs 1, 2, and 3.

### Differential Nonlinearity

Differential nonlinearity (DNL) is the difference between the measured change and the ideal 1 LSB change between any two adjacent codes. A specified differential nonlinearity of  $\pm 1$  LSB maximum ensures monotonicity. This DAC is guaranteed monotonic by design. Typical DNL versus code plots can be seen in TPCs 4, 5, and 6.

### Offset Error

This is a measure of the offset error of the DAC and the output amplifier. It is expressed as a percentage of the full-scale range.

### Gain Error

This is a measure of the span error of the DAC. It is the deviation in slope of the actual DAC transfer characteristic from the ideal expressed as a percentage of the full-scale range.

### Offset Error Drift

This is a measure of the change in offset error with changes in temperature. It is expressed in (ppm of full-scale range)/ $^{\circ}$ C.

### Gain Error Drift

This is a measure of the change in gain error with changes in temperature. It is expressed in (ppm of full-scale range)/ $^{\circ}$ C.

### Power Supply Rejection Ratio (PSRR)

This indicates how the output of the DAC is affected by changes in the supply voltage. PSRR is the ratio of the change in  $V_{OUT}$  to a change in  $V_{DD}$  for full-scale output of the DAC. It is measured in dB.  $V_{REF}$  is held at 2 V and  $V_{DD}$  is varied  $\pm 10\%$ .

### DC Crosstalk

This is the dc change in the output level of one DAC at midscale in response to a full-scale code change (all 0s to all 1s and vice versa) and output change of another DAC. It is expressed in  $\mu$ V.

### Reference Feedthrough

This is the ratio of the amplitude of the signal at the DAC output to the reference input when the DAC output is not being updated. It is expressed in dB.

### Major-Code Transition Glitch Energy

Major-code transition glitch energy is the energy of the impulse injected into the analog output when the code in the DAC register changes state. It is normally specified as the area of the glitch in nV-s and is measured when the digital code is changed by 1 LSB at the major carry transition (011 . . . 11 to 100 . . . 00 or 100 . . . 00 to 011 . . . 11).

### Digital Feedthrough

Digital feedthrough is a measure of the impulse injected into the analog output of the DAC from the digital input pins of the device when the DAC output is not being written to ( $\overline{\text{SYNC}}$  held high). It is specified in nV-s and is measured with a worst-case change on the digital input pins, e.g., from all 0s to all 1s or vice versa.

### Digital Crosstalk

This is the glitch impulse transferred to the output of one DAC at midscale in response to a full-scale code change (all 0s to all 1s and vice versa) in the input register of another DAC. It is expressed in nV-s.

### DAC-to-DAC Crosstalk

This is the glitch impulse transferred to the output of one DAC due to a digital code change and subsequent output change of another DAC. This includes both digital and analog crosstalk. It is measured by loading one of the DACs with a full-scale code change (all 0s to all 1s and vice versa) with the  $\overline{\text{LDAC}}$  bit set low and monitoring the output of another DAC. The energy of the glitch is expressed in nV-s.

### Multiplying Bandwidth

The amplifiers within the DAC have a finite bandwidth. The multiplying bandwidth is a measure of this. A sine wave on the reference (with full-scale code loaded to the DAC) appears on the output. The multiplying bandwidth is the frequency at which the output amplitude falls to 3 dB below the input.

### Total Harmonic Distortion

This is the difference between an ideal sine wave and its attenuated version using the DAC. The sine wave is used as the reference for the DAC and the THD is a measure of the harmonics present on the DAC output. It is measured in dB.

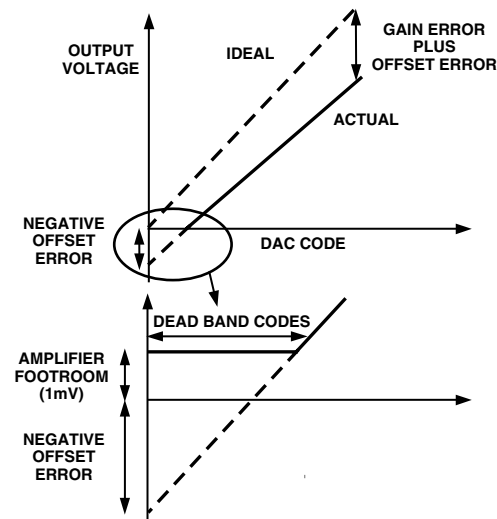

Figure 2. Transfer Function with Negative Offset

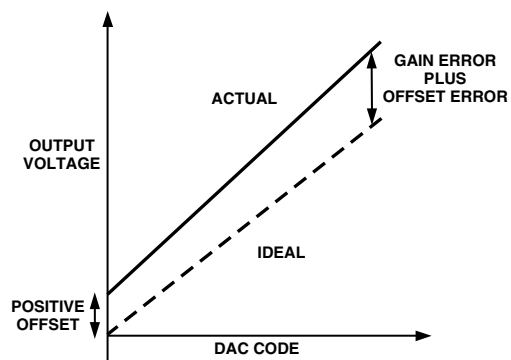
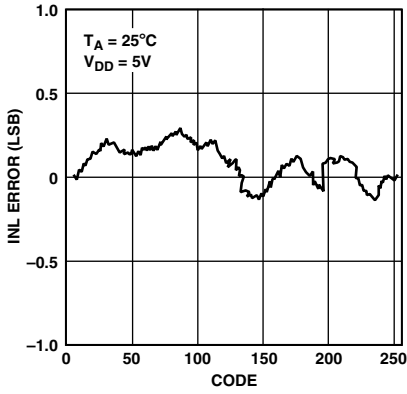
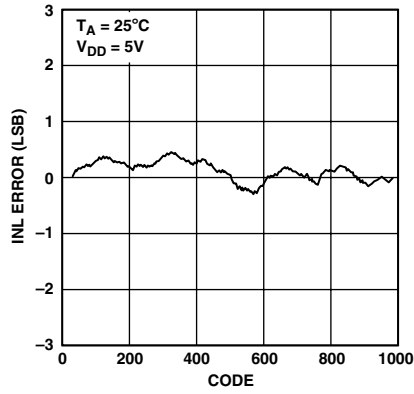

Figure 3. Transfer Function with Positive Offset

# Typical Performance Characteristics—AD5304/AD5314/AD5324



TPC 1. AD5304 Typical INL Plot



TPC 2. AD5314 Typical INL Plot

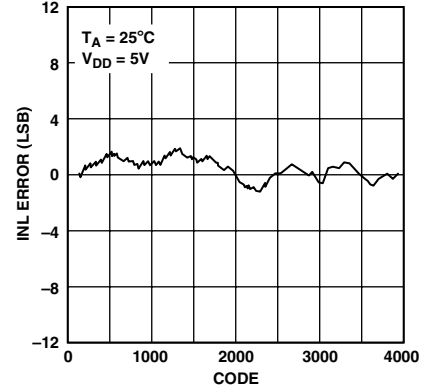

TPC 3. AD5324 Typical INL Plot

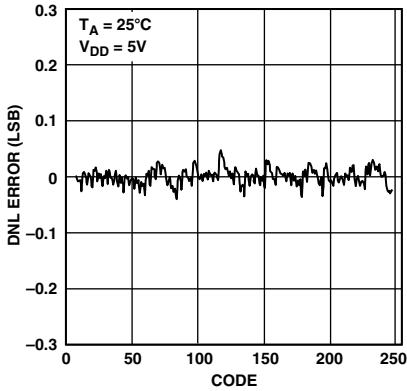

TPC 4. AD5304 Typical DNL Plot

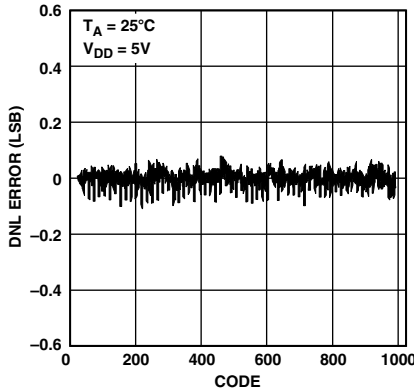

TPC 5. AD5314 Typical DNL Plot

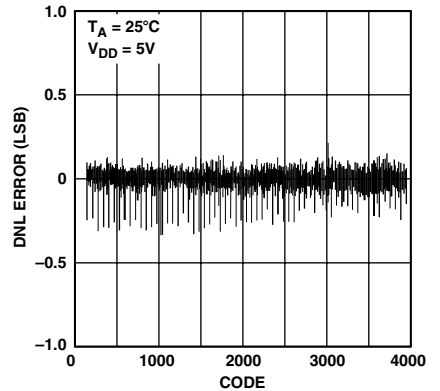

TPC 6. AD5324 Typical DNL Plot

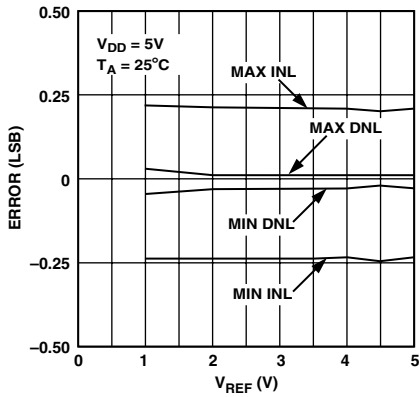

TPC 7. AD5304 INL and DNL Error vs.  $V_{REF}$

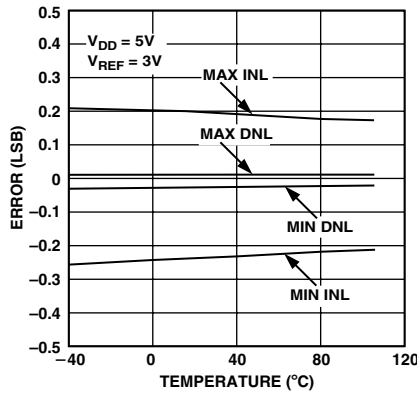

TPC 8. AD5304 INL Error and DNL Error vs. Temperature

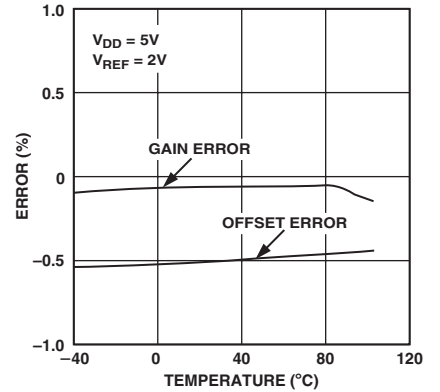

TPC 9. AD5304 Offset Error and Gain Error vs. Temperature

# AD5304/AD5314/AD5324

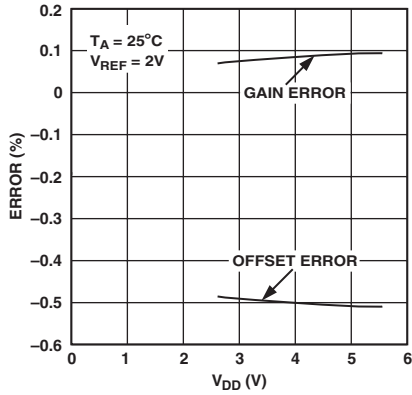

TPC 10. Offset Error and Gain Error vs.  $V_{DD}$

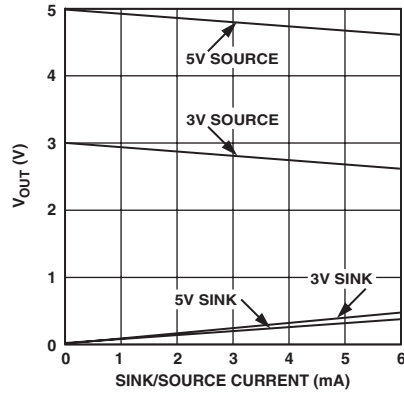

TPC 11.  $V_{OUT}$  Source and Sink Current Capability

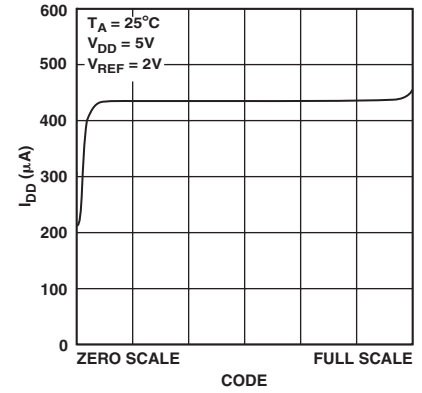

TPC 12. Supply Current vs. DAC Code

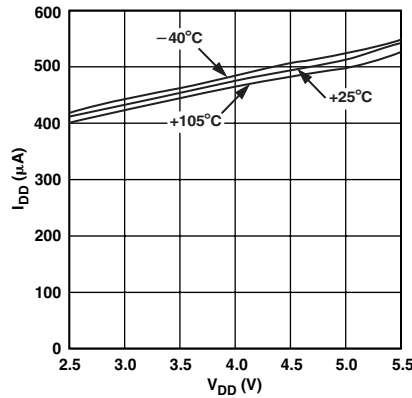

TPC 13. Supply Current vs. Supply Voltage

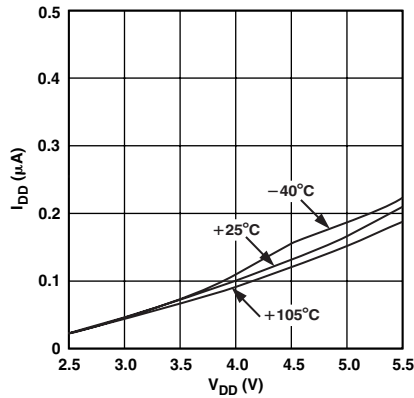

TPC 14. Power-Down Current vs. Supply Voltage

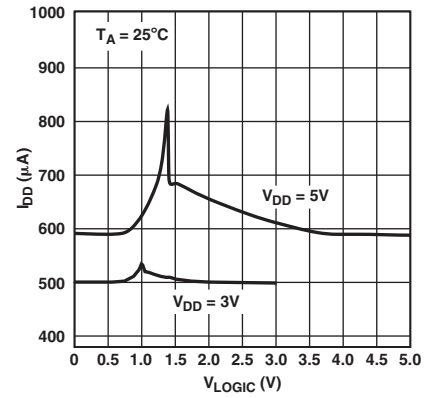

TPC 15. Supply Current vs. Logic Input Voltage

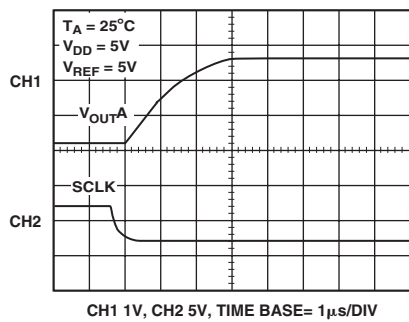

TPC 16. Half-Scale Settling (1/4 to 3/4 Scale Code Change)

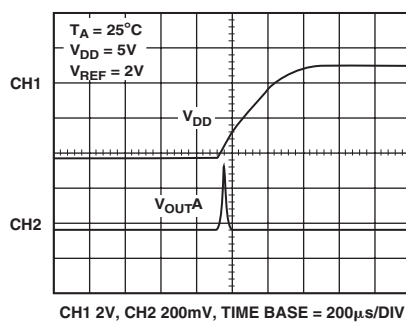

TPC 17. Power-On Reset to 0 V

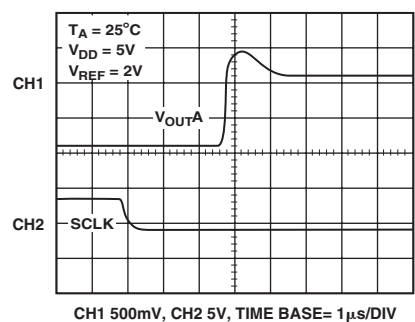

TPC 18. Exiting Power-Down to Midscale



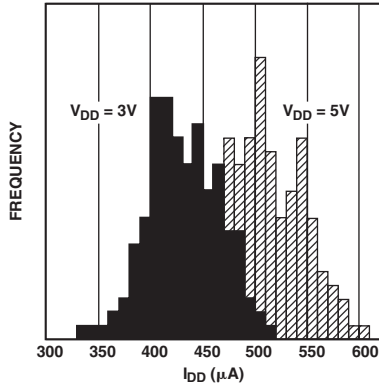

TPC 19.  $I_{DD}$  Histogram with  $V_{DD} = 3V$  and  $V_{DD} = 5V$

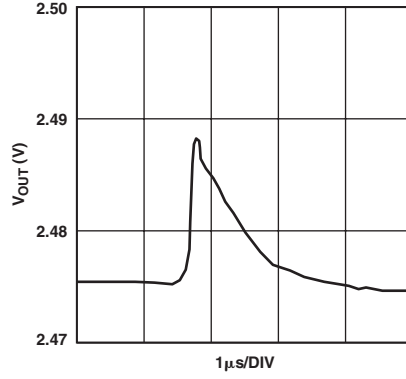

TPC 20. AD5324 Major-Code Transition Glitch Energy

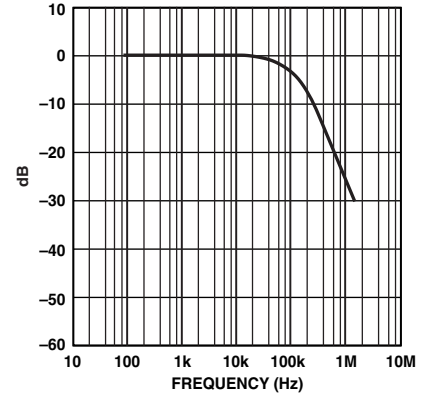

TPC 21. Multiplying Bandwidth (Small-Signal Frequency Response)

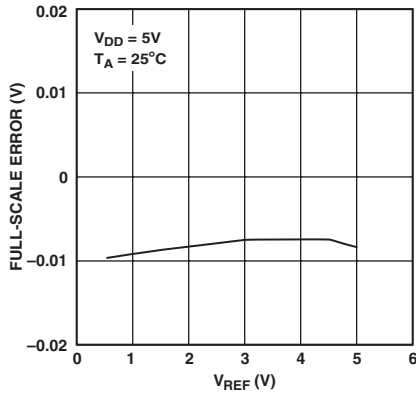

TPC 22. Full-Scale Error vs.  $V_{REF}$

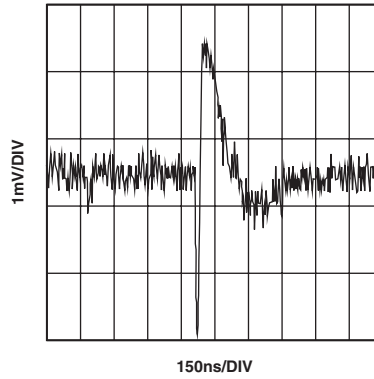

TPC 23. DAC-to-DAC Crosstalk

# AD5304/AD5314/AD5324

## FUNCTIONAL DESCRIPTION

The AD5304/AD5314/AD5324 are quad resistor-string DACs fabricated on a CMOS process with resolutions of 8, 10, and 12 bits, respectively. Each contains four output buffer amplifiers and is written to via a 3-wire serial interface. They operate from single supplies of 2.5 V to 5.5 V, and the output buffer amplifiers provide rail-to-rail output swing with a slew rate of 0.7 V/μs. The four DACs share a single reference input pin. The devices have programmable power-down modes, in which all DACs may be turned off completely with a high impedance output.

### Digital-to-Analog Section

The architecture of one DAC channel consists of a resistor-string DAC followed by an output buffer amplifier. The voltage at the REFIN pin provides the reference voltage for the DAC. Figure 4 shows a block diagram of the DAC architecture. Since the input coding to the DAC is straight binary, the ideal output voltage is given by

$$V_{OUT} = \frac{V_{REF} \times D}{2^N}$$

where

$D$  = decimal equivalent of the binary code, which is loaded to the DAC register:

- 0–255 for AD5304 (8 bits)
- 0–1023 for AD5314 (10 bits)
- 0–4095 for AD5324 (12 bits)

$N$  = DAC resolution

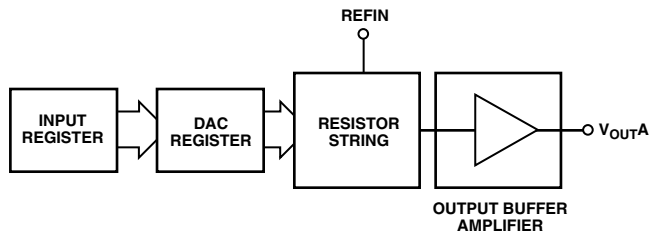

Figure 4. DAC Channel Architecture

### Resistor String

The resistor string section is shown in Figure 5. It is simply a string of resistors, each of value  $R$ . The digital code loaded to the DAC register determines at which node on the string the voltage is tapped off to be fed into the output amplifier. The voltage is tapped off by closing one of the switches connecting the string to the amplifier. Because it is a string of resistors, it is guaranteed monotonic.

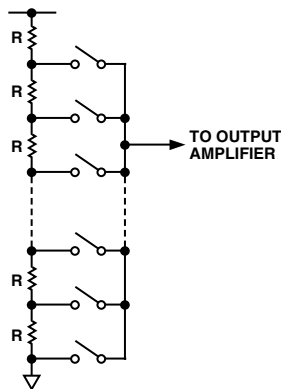

Figure 5. Resistor String

### DAC Reference Inputs

There is a single reference input pin for the four DACs. The reference input is unbuffered. The user can have a reference voltage as low as 0.25 V and as high as  $V_{DD}$  since there is no restriction due to headroom and footroom of any reference amplifier.

It is recommended to use a buffered reference in the external circuit (e.g., REF192). The input impedance is typically 45 kΩ.

### Output Amplifier

The output buffer amplifier is capable of generating rail-to-rail voltages on its output, which gives an output range of 0 V to  $V_{DD}$  when the reference is  $V_{DD}$ . It is capable of driving a load of 2 kΩ to GND or  $V_{DD}$ , in parallel with 500 pF to GND or  $V_{DD}$ . The source and sink capabilities of the output amplifier can be seen in the plot in TPC 11.

The slew rate is 0.7 V/μs with a half-scale settling time to ±0.5 LSB (at eight bits) of 6 μs.

### POWER-ON RESET

The AD5304/AD5314/AD5324 are provided with a power-on reset function, so that they power up in a defined state. The power-on state is

- Normal operation
- Output voltage set to 0 V

Both input and DAC registers are filled with zeros and remain so until a valid write sequence is made to the device. This is particularly useful in applications where it is important to know the state of the DAC outputs while the device is powering up.

### SERIAL INTERFACE

The AD5304/AD5314/AD5324 are controlled over a versatile, 3-wire serial interface, which operates at clock rates up to 30 MHz and is compatible with SPI, QSPI, MICROWIRE, and DSP interface standards.

### Input Shift Register

The input shift register is 16 bits wide. Data is loaded into the device as a 16-bit word under the control of a serial clock input, SCLK. The timing diagram for this operation is shown in Figure 1. The 16-bit word consists of four control bits followed by 8, 10, or 12 bits of DAC data, depending on the device type. Data is loaded MSB first (Bit 15) and the first two bits determine whether the data is for DAC A, DAC B, DAC C, or DAC D. Bits 13 and 12 control the operating mode of the DAC. Bit 13 is  $\overline{PD}$ , which determines whether the part is in normal or power-down mode. Bit 12 is  $\overline{LDAC}$ , which controls when DAC registers and outputs are updated.

Table I. Address Bits

A1	A0	DAC Addressed
0	0	DAC A
0	1	DAC B
1	0	DAC C
1	1	DAC D

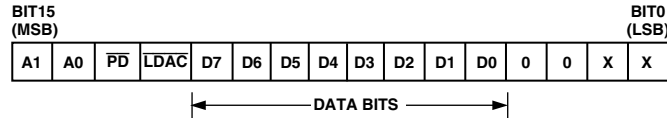

Figure 6. AD5304 Input Shift Register Contents

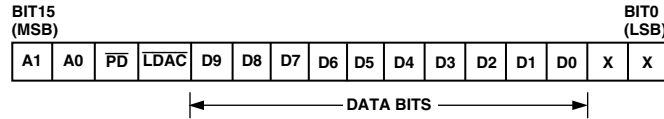

Figure 7. AD5314 Input Shift Register Contents

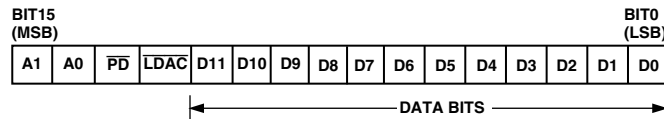

Figure 8. AD5324 Input Shift Register Contents

### Address and Control Bits

- PD** 0: All four DACs go into power-down mode, consuming only 200 nA @ 5 V. The DAC outputs enter a high impedance state.  
 1: Normal operation.
- LDAC** 0: All four DAC registers and, therefore, all DAC outputs updated simultaneously on completion of the write sequence.  
 1: Only addressed input register is updated. There is no change in the content of the DAC registers.

The AD5324 uses all 12 bits of DAC data; the AD5314 uses 10 bits and ignores the 2 LSB. The AD5304 uses eight bits and ignores the last four bits. The data format is straight binary, with all 0s corresponding to 0 V output and all 1s corresponding to full-scale output ( $V_{REF} - 1$  LSB).

The  $\overline{\text{SYNC}}$  input is a level-triggered input that acts as a frame synchronization signal and chip enable. Data can be transferred into the device only while  $\overline{\text{SYNC}}$  is low. To start the serial data transfer,  $\overline{\text{SYNC}}$  should be taken low, observing the minimum  $\overline{\text{SYNC}}$  to SCLK falling edge setup time,  $t_4$ . After  $\overline{\text{SYNC}}$  goes low, serial data will be shifted into the device's input shift register on the falling edges of SCLK for 16 clock pulses. Any data and clock pulses after the 16th falling edge of SCLK will be ignored because the SCLK and DIN input buffers are powered down. No further serial data transfer will occur until  $\overline{\text{SYNC}}$  is taken high and low again.

$\overline{\text{SYNC}}$  may be taken high after the falling edge of the 16th SCLK pulse, observing the minimum SCLK falling edge to  $\overline{\text{SYNC}}$  rising edge time,  $t_7$ .

After the end of serial data transfer, data will automatically be transferred from the input shift register to the input register of the selected DAC. If  $\overline{\text{SYNC}}$  is taken high before the 16th falling edge of SCLK, the data transfer will be aborted and the DAC input registers will not be updated.

When data has been transferred into three of the DAC input registers, all DAC registers and all DAC outputs may simultaneously be updated by setting  $\overline{\text{LDAC}}$  low when writing to the remaining DAC input register.

### Low Power Serial Interface

To reduce the power consumption of the device even further, the interface powers up fully only when the device is being written to, i.e., on the falling edge of  $\overline{\text{SYNC}}$ . As soon as the 16-bit control word has been written to the part, the SCLK and DIN input buffers are powered down. They power up again only following a falling edge of  $\overline{\text{SYNC}}$ .

### Double-Buffered Interface

The AD5304/AD5314/AD5324 DACs have double-buffered interfaces consisting of two banks of registers—input registers and DAC registers. The input register is directly connected to the input shift register and the digital code is transferred to the relevant input register on completion of a valid write sequence. The DAC register contains the digital code used by the resistor string.

Access to the DAC register is controlled by the  $\overline{\text{LDAC}}$  bit. When the  $\overline{\text{LDAC}}$  bit is set high, the DAC register is latched and hence the input register may change state without affecting the contents of the DAC register. However, when the  $\overline{\text{LDAC}}$  bit is set low, all DAC registers are updated after a complete write sequence.

This is useful if the user requires simultaneous updating of all DAC outputs. The user may write to three of the input registers individually and then, by setting the  $\overline{\text{LDAC}}$  bit low when writing to the remaining DAC input register, all outputs will update simultaneously.

These parts contain an extra feature whereby the DAC register is not updated unless its input register has been updated since the last time that  $\overline{\text{LDAC}}$  was brought low. Normally, when  $\overline{\text{LDAC}}$  is brought low, the DAC registers are filled with the contents of the input registers. In the case of the AD5304/AD5314/AD5324, the part will update the DAC register only if the input register has been changed since the last time the DAC register was updated, thereby removing unnecessary digital crosstalk.

### POWER-DOWN MODE

The AD5304/AD5314/AD5324 have low power consumption, dissipating only 1.5 mW with a 3 V supply and 3 mW with a 5 V supply. Power consumption can be further reduced when the DACs are not in use by putting them into power-down mode, which is selected by a 0 on Bit 13 ( $\overline{\text{PD}}$ ) of the control word.

# AD5304/AD5314/AD5324

When the  $\overline{PD}$  bit is set to 1, all DACs work normally with a typical power consumption of 600  $\mu\text{A}$  at 5 V (500  $\mu\text{A}$  at 3 V). However, in power-down mode, the supply current falls to 200 nA at 5 V (80 nA at 3 V) when all DACs are powered down. Not only does the supply current drop, but the output stage is also internally switched from the output of the amplifier, making it open-circuit. This has the advantage that the output is three-stated while the part is in power-down mode, and provides a defined input condition for whatever is connected to the output of the DAC amplifier. The output stage is illustrated in Figure 9.

The bias generator, the output amplifier, the resistor string, and all other associated linear circuitry are shut down when the power-down mode is activated. However, the contents of the registers are unaffected when in power-down. The time to exit power-down is typically 2.5  $\mu\text{s}$  for  $V_{DD} = 5\text{ V}$  and 5  $\mu\text{s}$  when  $V_{DD} = 3\text{ V}$ . This is the time from the falling edge of the 16th SCLK pulse to when the output voltage deviates from its power-down voltage. See TPC 18 for a plot.

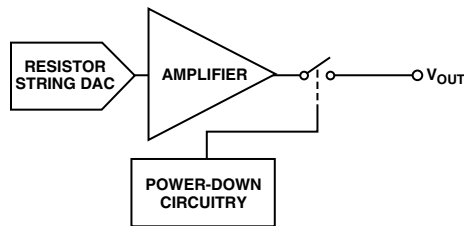
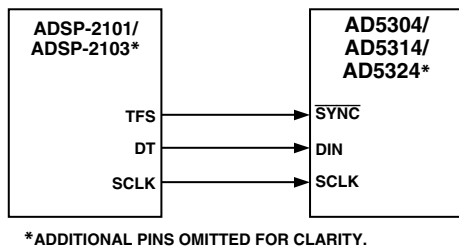

Figure 9. Output Stage during Power-Down

## MICROPROCESSOR INTERFACING

### AD5304/AD5314/AD5324 to ADSP-2101/ADSP-2103 Interface

Figure 10 shows a serial interface between the AD5304/AD5314/AD5324 and the ADSP-2101/ADSP-2103. The ADSP-2101/ADSP-2103 should be set up to operate in the SPORT transmit alternate framing mode. The ADSP-2101/ADSP-2103 sport is programmed through the SPORT control register and should be configured as follows: internal clock operation, active-low framing, 16-bit word length. Transmission is initiated by writing a word to the Tx register after the SPORT has been enabled. The data is clocked out on each rising edge of the DSP's serial clock and clocked into the AD5304/AD5314/AD5324 on the falling edge of the DAC's SCLK.



\*ADDITIONAL PINS OMITTED FOR CLARITY.

Figure 10. AD5304/AD5314/AD5324 to ADSP-2101/ADSP-2103 Interface

### AD5304/AD5314/AD5324 to 68HC11/68L11 Interface

Figure 11 shows a serial interface between the AD5304/AD5314/AD5324 and the 68HC11/68L11 microcontroller. SCK of the 68HC11/68L11 drives the SCLK of the AD5304/AD5314/AD5324, while the MOSI output drives the serial data line (DIN) of the DAC. The  $\overline{SYNC}$  signal is derived from a port line (PC7). The setup conditions for correct operation of this interface are as follows: the 68HC11/68L11 should be configured so that its CPOL bit is a 0 and its CPHA bit is a 1. When data is being transmitted to the DAC, the  $\overline{SYNC}$  line is taken low (PC7). When the 68HC11/68L11 is configured as above, data appearing on the MOSI output is valid on the falling edge of SCK. Serial data from the 68HC11/68L11 is transmitted in 8-bit bytes with only eight falling clock edges occurring in the transmit cycle. Data is transmitted MSB first. To load data to the AD5304/AD5314/AD5324, PC7 is left low after the first eight bits are transferred, a second serial write operation is performed to the DAC, and PC7 is taken high at the end of this procedure.

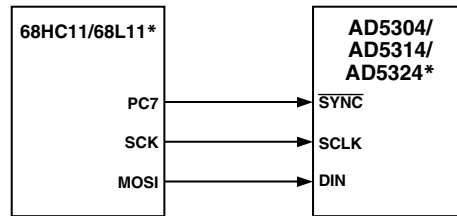

\*ADDITIONAL PINS OMITTED FOR CLARITY.

Figure 11. AD5304/AD5314/AD5324 to 68HC11/68L11 Interface

### AD5304/AD5314/AD5324 to 80C51/80L51 Interface

Figure 12 shows a serial interface between the AD5304/AD5314/AD5324 and the 80C51/80L51 microcontroller. The setup for the interface is as follows: TxD of the 80C51/80L51 drives SCLK of the AD5304/AD5314/AD5324, while RxD drives the serial data line of the part. The  $\overline{SYNC}$  signal is again derived from a bit-programmable pin on the port. In this case, port line P3.3 is used. When data is to be transmitted to the AD5304/AD5314/AD5324, P3.3 is taken low. The 80C51/80L51 transmits data only in 8-bit bytes; thus only eight falling clock edges occur in the transmit cycle. To load data to the DAC, P3.3 is left low after the first eight bits are transmitted, and a second write cycle is initiated to transmit the second byte of data. P3.3 is taken high following the completion of this cycle. The 80C51/80L51 outputs the serial data in a format that has the LSB first. The AD5304/AD5314/AD5324 requires its data with the MSB as the first bit received. The 80C51/80L51 transmit routine should take this into account.

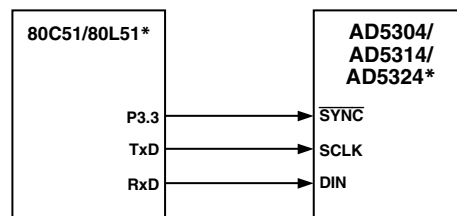

\*ADDITIONAL PINS OMITTED FOR CLARITY.

Figure 12. AD5304/AD5314/AD5324 to 80C51/80L51 Interface

## AD5304/AD5314/AD5324 to MICROWIRE Interface

Figure 13 shows an interface between the AD5304/AD5314/AD5324 and any MICROWIRE compatible device. Serial data is shifted out on the falling edge of the serial clock, SK, and is clocked into the AD5304/AD5314/AD5324 on the rising edge of SK, which corresponds to the falling edge of the DAC's SCLK.

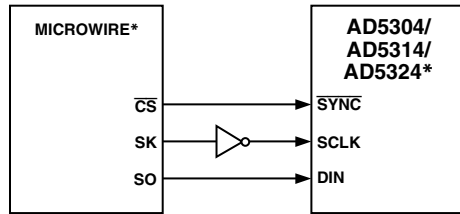

\*ADDITIONAL PINS OMITTED FOR CLARITY.

Figure 13. AD5304/AD5314/AD5324 to MICROWIRE Interface

## APPLICATIONS

### Typical Application Circuit

The AD5304/AD5314/AD5324 can be used with a wide range of reference voltages where the devices offer full, one-quadrant multiplying capability over a reference range of 0 V to  $V_{DD}$ . More typically, these devices are used with a fixed, precision reference voltage. Suitable references for 5 V operation are the AD780 and REF192 (2.5 V references). For 2.5 V operation, a suitable external reference would be the AD589, a 1.23 V band gap reference. Figure 14 shows a typical setup for the AD5304/AD5314/AD5324 when using an external reference.

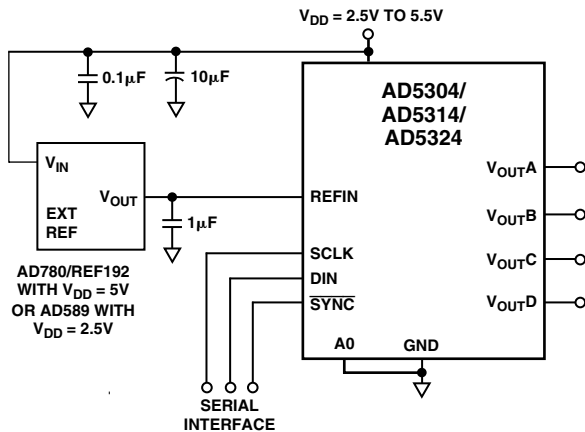

Figure 14. AD5304/AD5314/AD5324 Using External Reference

If an output range of 0 V to  $V_{DD}$  is required, the simplest solution is to connect the reference input to  $V_{DD}$ . As this supply may not be very accurate and may be noisy, the AD5304/AD5314/AD5324 may be powered from the reference voltage; for example, using a 5 V reference such as the REF195. The REF195 will output a steady supply voltage for the AD5304/AD5314/AD5324. The current required from the REF195 is 600  $\mu$ A supply current and approximately 112  $\mu$ A into the reference input. This is with no load on the DAC outputs. When the DAC outputs are loaded, the REF195 also needs to supply the current to the loads. The total current required (with a 10 k $\Omega$  load on each output) is

$$712 \mu A + 4(5 V / 10 k\Omega) = 2.70 mA$$

The load regulation of the REF195 is typically 2 ppm/mA, which results in an error of 5.4 ppm (27  $\mu$ V) for the 2.7 mA current drawn from it. This corresponds to a 0.0014 LSB error at eight bits and 0.022 LSB error at 12 bits.

### Bipolar Operation Using the AD5304/AD5314/AD5324

The AD5304/AD5314/AD5324 have been designed for single-supply operation, but a bipolar output range is also possible using the circuit in Figure 15. This circuit will give an output voltage range of  $\pm 5$  V. Rail-to-rail operation at the amplifier output is achievable using an AD820 or an OP295 as the output amplifier.

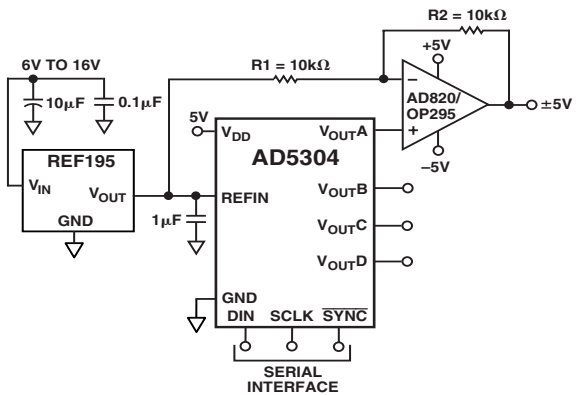

Figure 15. Bipolar Operation with the AD5304

The output voltage for any input code can be calculated as follows:

$$V_{OUT} = \left[ \frac{(REFIN \times D / 2^N) \times (R1 + R2)}{R1 - REFIN \times (R2 / R1)} \right]$$

where

$D$  is the decimal equivalent of the code loaded to the DAC.  
 $N$  is the DAC resolution.

$REFIN$  is the reference voltage input.

with

$REFIN = 5$  V,  $R1 = R2 = 10$  k $\Omega$ :

$$V_{OUT} = (10 \times D / 2^N) - 5 V$$

### Opto-Isolated Interface for Process Control Applications

The AD5304/AD5314/AD5324 have a versatile 3-wire serial interface, making them ideal for generating accurate voltages in process control and industrial applications. Due to noise, safety requirements, or distance, it may be necessary to isolate the AD5304/AD5314/AD5324 from the controller. This can easily be achieved by using opto-isolators, which will provide isolation in excess of 3 kV. The actual data rate achieved may be limited by the type of optocouplers chosen. The serial loading structure of the AD5304/AD5314/AD5324 makes them ideally suited for use in opto-isolated applications. Figure 16 shows an opto-isolated interface to the AD5304 where DIN, SCLK, and SYNC are driven from optocouplers. The power supply to the part also needs to be isolated. This is done by using a transformer. On the DAC side of the transformer, a 5 V regulator provides the 5 V supply required for the AD5304.



# AD5304/AD5314/AD5324

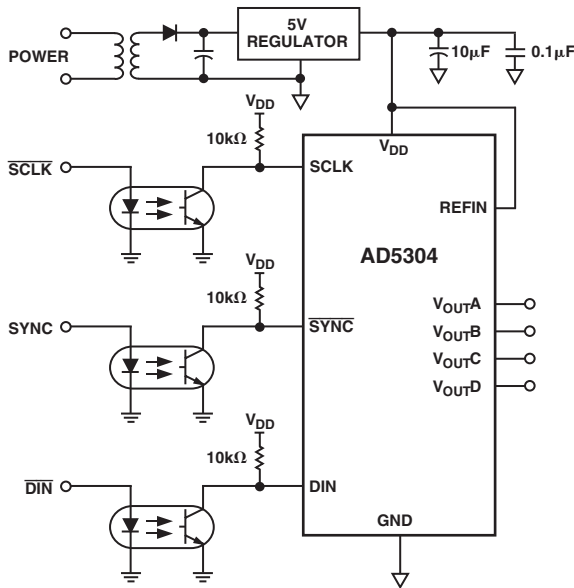

Figure 16. AD5304 in an Opto-Isolated Interface

## Decoding Multiple AD5304/AD5314/AD5324s

The SYNC pin on the AD5304/AD5314/AD5324 can be used in applications to decode a number of DACs. In this application, all the DACs in the system receive the same serial clock and serial data, but the SYNC to only one of the devices will be active at any one time, allowing access to four channels in this 16-channel system. The 74HC139 is used as a 2-to-4-line decoder to address any of the DACs in the system. To prevent timing errors, the enable input should be brought to its inactive state while the coded address inputs are changing state. Figure 17 shows a diagram of a typical setup for decoding multiple AD5304 devices in a system.

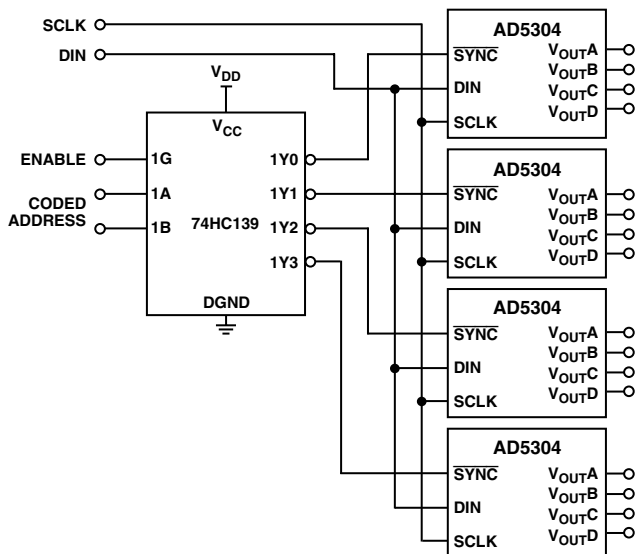

Figure 17. Decoding Multiple AD5304 Devices in a System

## AD5304/AD5314/AD5324 as a Digitally Programmable Window Detector

A digitally programmable upper/lower limit detector using two of the DACs in the AD5304/AD5314/AD5324 is shown in Figure 18. The upper and lower limits for the test are loaded to DACs A and B, which, in turn, set the limits on the CMP04. If the signal at the  $V_{IN}$  input is not within the programmed window, an LED will indicate the fail condition. Similarly, DACs C and D can be used for window detection on a second  $V_{IN}$  signal.

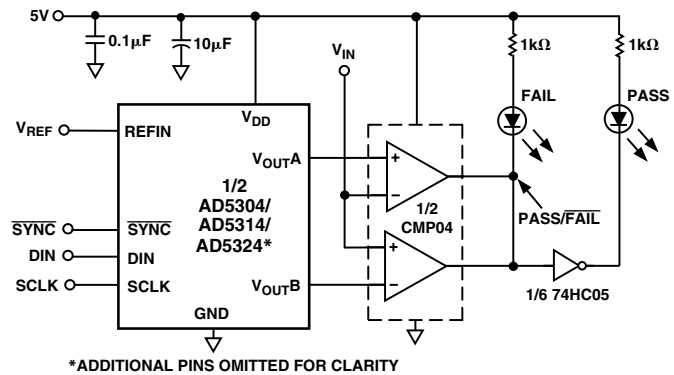

Figure 18. Window Detection

## POWER SUPPLY BYPASSING AND GROUNDING

In any circuit where accuracy is important, careful consideration of the power supply and ground return layout helps to ensure the rated performance. The printed circuit board on which the AD5304/AD5314/AD5324 is mounted should be designed so that the analog and digital sections are separated and confined to certain areas of the board. If the AD5304/AD5314/AD5324 is in a system where multiple devices require an AGND-to-DGND connection, the connection should be made at one point only. The star ground point should be established as close as possible to the device. The AD5304/AD5314/AD5324 should have ample supply bypassing of 10 µF in parallel with 0.1 µF on the supply located as close to the package as possible, ideally right up against the device. The 10 µF capacitors are the tantalum bead type. The 0.1 µF capacitor should have low effective series resistance (ESR) and effective series inductance (ESI), like the common ceramic types that provide a low impedance path to ground at high frequencies, to handle transient currents due to internal logic switching.

The power supply lines of the AD5304/AD5314/AD5324 should use as large a trace as possible to provide low impedance paths and reduce the effects of glitches on the power supply line. Fast switching signals such as clocks should be shielded with digital ground to avoid radiating noise to other parts of the board, and should never be run near the reference inputs. Avoid crossover of digital and analog signals. Traces on opposite sides of the board should run at right angles to each other. This reduces the effects of feedthrough through the board. A microstrip technique is by far the best, but is not always possible with a double-sided board. In this technique, the component side of the board is dedicated to ground plane while signal traces are placed on the solder side.

# AD5304/AD5314/AD5324

**Table II. Overview of AD53xx Serial Devices**

Part No.	Resolution	No. of DACs	DNL	Interface	Settling Time ( $\mu$ s)	Package	Pins
<b>SINGLES</b>							
AD5300	8	1	$\pm 0.25$	SPI	4	SOT-23, MSOP	6, 8
AD5310	10	1	$\pm 0.5$	SPI	6	SOT-23, MSOP	6, 8
AD5320	12	1	$\pm 1.0$	SPI	8	SOT-23, MSOP	6, 8
AD5301	8	1	$\pm 0.25$	2-Wire	6	SOT-23, MSOP	6, 8
AD5311	10	1	$\pm 0.5$	2-Wire	7	SOT-23, MSOP	6, 8
AD5321	12	1	$\pm 1.0$	2-Wire	8	SOT-23, MSOP	6, 8
<b>DUALS</b>							
AD5302	8	2	$\pm 0.25$	SPI	6	MSOP	8
AD5312	10	2	$\pm 0.5$	SPI	7	MSOP	8
AD5322	12	2	$\pm 1.0$	SPI	8	MSOP	8
AD5303	8	2	$\pm 0.25$	SPI	6	TSSOP	16
AD5313	10	2	$\pm 0.5$	SPI	7	TSSOP	16
AD5323	12	2	$\pm 1.0$	SPI	8	TSSOP	16
<b>QUADS</b>							
AD5304	8	4	$\pm 0.25$	SPI	6	MSOP	10
AD5314	10	4	$\pm 0.5$	SPI	7	MSOP	10
AD5324	12	4	$\pm 1.0$	SPI	8	MSOP	10
AD5305	8	4	$\pm 0.25$	2-Wire	6	MSOP	10
AD5315	10	4	$\pm 0.5$	2-Wire	7	MSOP	10
AD5325	12	4	$\pm 1.0$	2-Wire	8	MSOP	10
AD5306	8	4	$\pm 0.25$	2-Wire	6	TSSOP	16
AD5316	10	4	$\pm 0.5$	2-Wire	7	TSSOP	16
AD5326	12	4	$\pm 1.0$	2-Wire	8	TSSOP	16
AD5307	8	4	$\pm 0.25$	SPI	6	TSSOP	16
AD5317	10	4	$\pm 0.5$	SPI	7	TSSOP	16
AD5327	12	4	$\pm 1.0$	SPI	8	TSSOP	16
<b>OCTALS</b>							
AD5308	8	8	$\pm 0.25$	SPI	6	TSSOP	16
AD5318	10	8	$\pm 0.5$	SPI	7	TSSOP	16
AD5328	12	8	$\pm 1.0$	SPI	8	TSSOP	16

Visit [www.analog.com/support/standard\\_linear/selection\\_guides/AD53xx.html](http://www.analog.com/support/standard_linear/selection_guides/AD53xx.html) for more information.

**Table III. Overview of AD53xx Parallel Devices**

Part No.	Resolution	DNL	$V_{REF}$ Pins	Settling Time ( $\mu$ s)	Additional Pin Functions				Package	Pins
					BUF	GAIN	HBEN	CLR		
<b>SINGLES</b>										
AD5330	8	$\pm 0.25$	1	6	✓	✓		✓	TSSOP	20
AD5331	10	$\pm 0.5$	1	7		✓		✓	TSSOP	20
AD5340	12	$\pm 1.0$	1	8	✓	✓		✓	TSSOP	24
AD5341	12	$\pm 1.0$	1	8	✓	✓	✓	✓	TSSOP	20
<b>DUALS</b>										
AD5332	8	$\pm 0.25$	2	6				✓	TSSOP	20
AD5333	10	$\pm 0.5$	2	7	✓	✓		✓	TSSOP	24
AD5342	12	$\pm 1.0$	2	8	✓	✓		✓	TSSOP	28
AD5343	12	$\pm 1.0$	1	8			✓	✓	TSSOP	20
<b>QUADS</b>										
AD5334	8	$\pm 0.25$	2	6		✓		✓	TSSOP	24
AD5335	10	$\pm 0.5$	2	7			✓	✓	TSSOP	24
AD5336	10	$\pm 0.5$	4	7		✓		✓	TSSOP	28
AD5344	12	$\pm 1.0$	4	8				✓	TSSOP	28

OUTLINE DIMENSIONS

10-Lead Mini Small Outline Package [MSOP]  
(RM-10)

Dimensions shown in millimeters

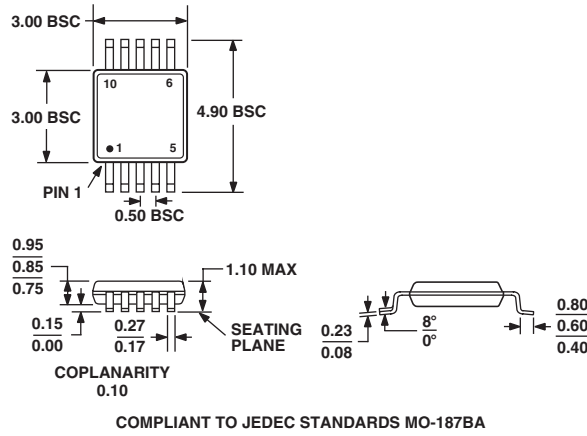

C00929-0-8/03(D)

Revision History

Location	Page
<b>8/03—Data Sheet changed from REV. C to REV. D.</b>	
Added A Version . . . . .	Universal
Changes to FEATURES . . . . .	1
Changes to SPECIFICATIONS . . . . .	2
Changes to ABSOLUTE MAXIMUM RATINGS . . . . .	4
Changes to ORDERING GUIDE . . . . .	4
Changes to Figure 6 . . . . .	11
Added OCTALS section to Table II . . . . .	15
Updated OUTLINE DIMENSIONS . . . . .	16