

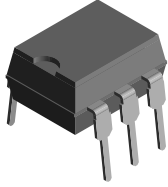

Optocoupler, Phototransistor Output, No Base Connection

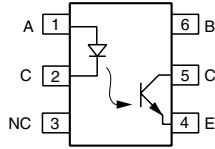

1179009



FEATURES

- Isolation test voltage, 5300 V_{RMS}
- No base terminal connection for improved common mode interface immunity
- Long term stability
- Industry standard dual in line package
- Lead (Pb)-free component
- Component in accordance to RoHS 2002/95/EC and WEEE 2002/96/EC



RoHS
COMPLIANT

DESCRIPTION

The MOC8101/2/3/4/5 family optocoupler consisting of a gallium arsenide infrared emitting diode optically coupled to a silicon planar phototransistor detector in a plastic plug-in DIP-6 package.

The coupling device is suitable for signal transmission between two electrically separated circuits. The potential difference between the circuits to be coupled should not exceed the maximum permissible reference voltages.

The base terminal of the MOC8101/2/3/4/5 is not connected, resulting in a substantially improved common mode interference immunity.

AGENCY APPROVALS

- UL1577, file no. E52744 system code H or J, double protection
- CSA 93751
- BSI IEC 60950; IEC 60065
- DIN EN 60747-5-2 (VDE 0884)/DIN EN 60747-5-5 pending available with option 1

ORDER INFORMATION

PART	REMARKS
MOC8101	CTR 50 to 80 %, DIP-6
MOC8102	CTR 73 to 117 %, DIP-6
MOC8103	CTR 108 to 173 %, DIP-6
MOC8104	CTR 160 to 256 %, DIP-6
MOC8105	CTR 65 to 133 %, DIP-6
MOC8101-X006	CTR 50 to 80 %, DIP-6 400 mil (option 6)
MOC8101-X007	CTR 50 to 80 %, SMD-6 (option 7)
MOC8101-X009	CTR 50 to 80 %, SMD-6 (option 9)
MOC8102-X006	CTR 73 to 117 %, DIP-6 400 mil (option 6)
MOC8102-X007	CTR 73 to 117 %, SMD-6 (option 7)
MOC8102-X009	CTR 73 to 117 %, SMD-6 (option 9)
MOC8104-X006	CTR 160 to 256 %, DIP-6 400 mil (option 6)
MOC8104-X009	CTR 160 to 256 %, SMD-6 (option 9)
MOC8105-X006	CTR 65 to 133 %, DIP-6 400 mil (option 6)
MOC8105-X009	CTR 65 to 133 %, SMD-6 (option 9)

Note

For additional information on the available options refer to option information.

MOC8101/MOC8102/MOC8103/MOC8104/MOC8105



Vishay Semiconductors Optocoupler, Phototransistor Output,
No Base Connection

ABSOLUTE MAXIMUM RATINGS ⁽¹⁾				
PARAMETER	TEST CONDITION	SYMBOL	VALUE	UNIT
INPUT				
Reverse voltage		V_R	6.0	V
Forward continuous current		I_F	60	mA
Surge forward current	$t \leq 10 \mu\text{s}$	I_{FSM}	2.5	A
Power dissipation		P_{diss}	100	mW
Derate linearly from 25°C			1.33	mW/°C
OUTPUT				
Collector emitter breakdown voltage		BV_{CEO}	30	V
Emitter collector breakdown voltage		BV_{ECO}	7.0	V
Collector current		I_C	50	mA
Derate linearly from 25°C			2.0	mW/°C
Power dissipation		P_{diss}	150	mW
COUPLER				
Isolation test voltage		V_{ISO}	5300	V_{RMS}
Creepage distance			≥ 7.0	mm
Clearance distance			≥ 7.0	mm
Isolation thickness between emitter and detector			≥ 0.4	mm
Comparative tracking index per DIN IEC 112/VDE 0303, part 1		CTI	175	
Isolation resistance	$V_{IO} = 500 \text{ V}$	R_{IO}	10^{12}	Ω
Derate linearly from 25 °C			3.33	mW/°C
Total power dissipation		P_{tot}	250	mW
Storage temperature		T_{stg}	- 55 to + 150	°C
Operating temperature		T_{amb}	- 55 to + 100	°C
Junction temperature		T_j	100	°C
Soldering temperature ⁽²⁾	max. 10 s, dip soldering: distance to seating plane $\geq 1.5 \text{ mm}$	T_{sld}	260	°C

Notes

(1) $T_{amb} = 25 \text{ °C}$, unless otherwise specified.

Stresses in excess of the absolute maximum ratings can cause permanent damage to the device. Functional operation of the device is not implied at these or any other conditions in excess of those given in the operational sections of this document. Exposure to absolute maximum ratings for extended periods of the time can adversely affect reliability.

(2) Refer to reflow profile for soldering conditions for surface mounted devices (SMD). Refer to wave profile for soldering conditions for through hole devices (DIP).

ELECTRICAL CHARACTERISTICS							
PARAMETER	TEST CONDITION	PART	SYMBOL	MIN.	TYP.	MAX.	UNIT
INPUT							
Forward voltage	$I_F = 10 \text{ mA}$		V_F		1.25	1.5	V
Breakdown voltage	$I_R = 10 \mu\text{A}$		V_{BR}	6.0			V
Reverse current	$V_R = 6.0 \text{ V}$		I_R		0.01	10	μA
Capacitance	$V_R = 0 \text{ V}, f = 1.0 \text{ MHz}$		C_O		25		pF
Thermal resistance			R_{thja}		750		K/W
OUTPUT							
Collector emitter capacitance	$V_{CE} = 5.0 \text{ V}, f = 1.0 \text{ MHz}$		C_{CE}		5.2		pF
Collector emitter dark current	$V_{CE} = 10 \text{ V}, T_{amp} = 25 \text{ °C}$	MOC8101	I_{CEO1}		1.0	50	nA
	$V_{CE} = 10 \text{ V}, T_{amp} = 100 \text{ °C}$	MOC8102	I_{CEO1}		1.0		μA
Collector emitter breakdown voltage	$I_C = 1.0 \text{ mA}$		BV_{CEO}	30			V
Emitter collector breakdown voltage	$I_E = 100 \mu\text{A}$		BV_{ECO}	7.0			V
Thermal resistance			R_{thja}		500		K/W



MOC8101/MOC8102/MOC8103/MOC8104/MOC8105

Optocoupler, Phototransistor Output, Vishay Semiconductors
No Base Connection

ELECTRICAL CHARACTERISTICS							
PARAMETER	TEST CONDITION	PART	SYMBOL	MIN.	TYP.	MAX.	UNIT
COUPLER							
Saturation voltage collector emitter	$I_F = 5.0 \text{ mA}$		V_{CEsat}		0.25	0.4	V
Coupling capacitance			C_C		0.6		pF

Note

$T_{amb} = 25 \text{ }^\circ\text{C}$, unless otherwise specified.

Minimum and maximum values are testing requirements. Typical values are characteristics of the device and are the result of engineering evaluation. Typical values are for information only and are not part of the testing requirements.

CURRENT TRANSFER RATIO							
PARAMETER	TEST CONDITION	PART	SYMBOL	MIN.	TYP.	MAX.	UNIT
Current transfer ratio	$V_{CE} = 10 \text{ V}, I_F = 10 \text{ mA}$	MOC8101	CTR	50		80	%
		MOC8102	CTR	73		117	%
		MOC8103	CTR	108		173	%
		MOC8104	CTR	160		256	%
		MOC8105	CTR	65		133	%

SWITCHING CHARACTERISTICS							
PARAMETER	TEST CONDITION	SYMBOL	MIN.	TYP.	MAX.	UNIT	
Turn-on time	$V_{CC} = 10 \text{ V}, I_C = 2.0 \text{ mA}, R_L = 100 \text{ } \Omega$	t_{on}		3.0		μs	
Turn-off time	$V_{CC} = 10 \text{ V}, I_C = 2.0 \text{ mA}, R_L = 100 \text{ } \Omega$	t_{off}		2.3		μs	
Rise time	$V_{CC} = 10 \text{ V}, I_C = 2.0 \text{ mA}, R_L = 100 \text{ } \Omega$	t_r		2.0		μs	
Fall time	$V_{CC} = 10 \text{ V}, I_C = 2.0 \text{ mA}, R_L = 100 \text{ } \Omega$	t_f		2.0		μs	
Cut off frequency		f_{co}		250		kHz	

TYPICAL CHARACTERISTICS

$T_{amb} = 25 \text{ }^\circ\text{C}$ unless otherwise specified

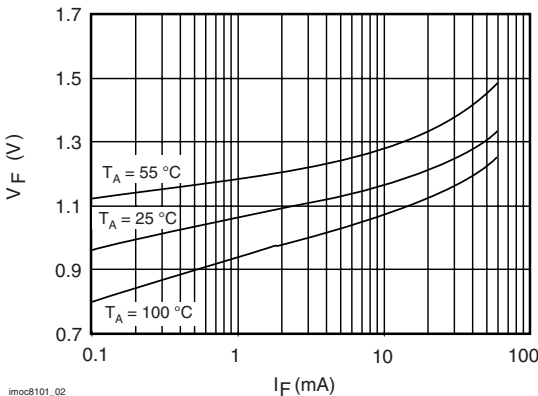

Fig. 1 - Forward Voltage vs. Forward Current

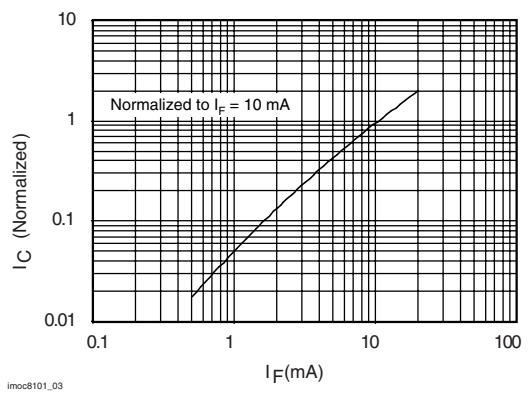
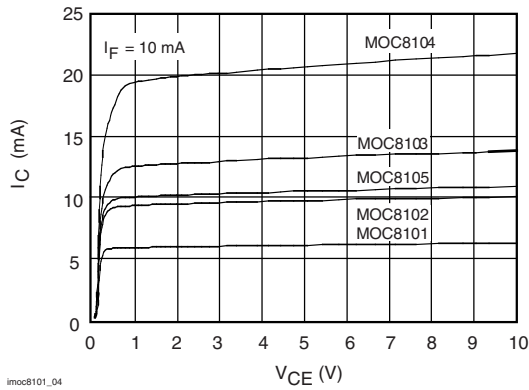
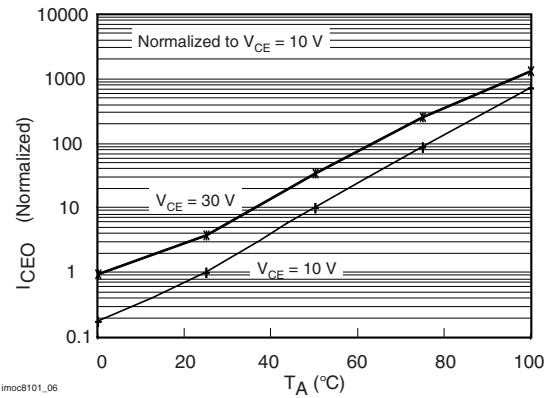

Fig. 2 - Collector Current vs. LED Forward Current



imoc8101_04

Fig. 3 - Collector Current vs. Collector Emitter Voltage



imoc8101_06

Fig. 5 - Collector Emitter Dark Current vs. Ambient Temperature

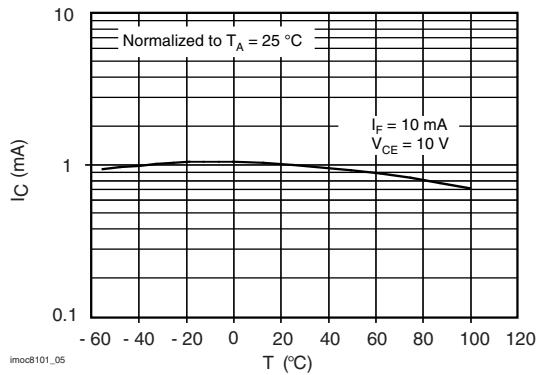

imoc8101_05

Fig. 4 - Collector Current vs. Ambient Temperature

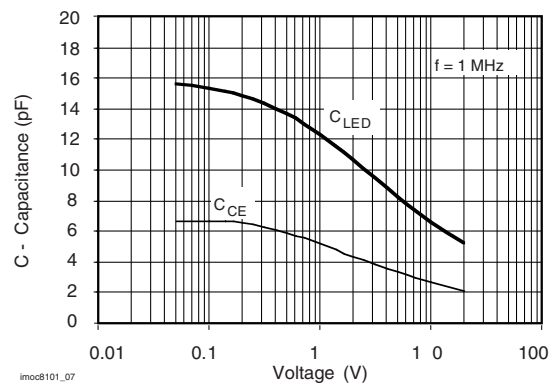

imoc8101_07

Fig. 6 - Capacitance vs. Voltage

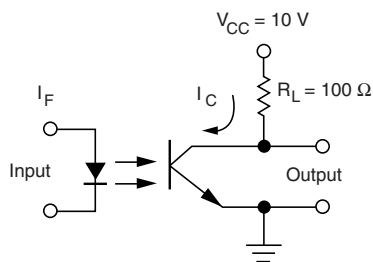

Test circuit

imoc81010_01

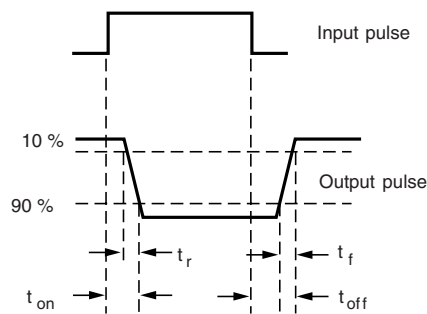

Waveforms

Fig. 7 - Switching Time Test Circuit and Waveforms



MOC8101/MOC8102/MOC8103/MOC8104/MOC8105

Optocoupler, Phototransistor Output, Vishay Semiconductors
No Base Connection

PACKAGE DIMENSIONS in inches (millimeters)

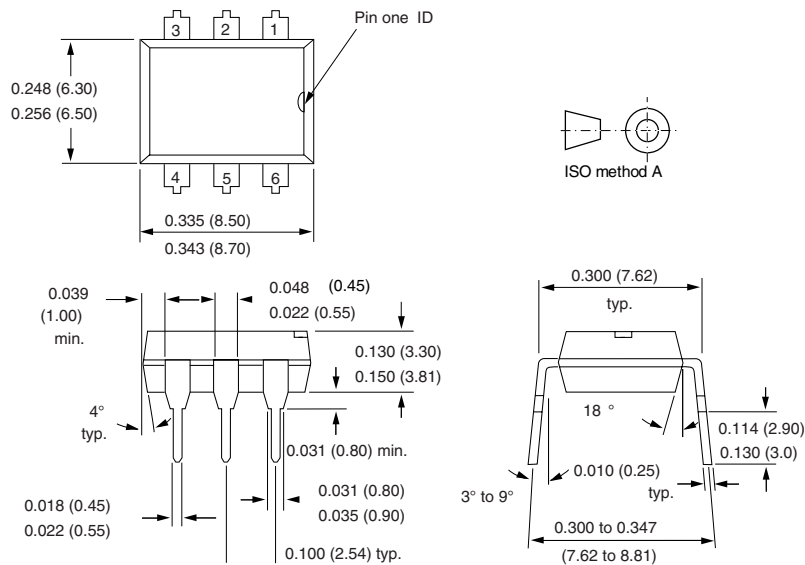

i178004

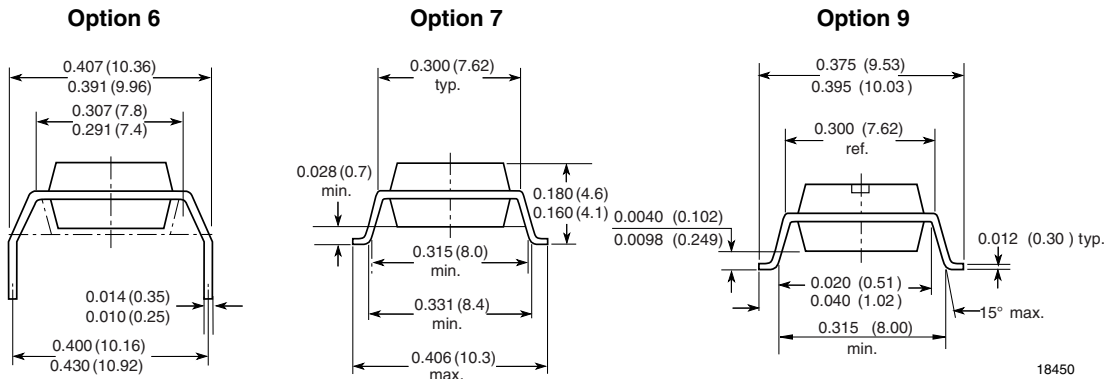



OZONE DEPLETING SUBSTANCES POLICY STATEMENT

It is the policy of Vishay Semiconductor GmbH to

1. Meet all present and future national and international statutory requirements.
2. Regularly and continuously improve the performance of our products, processes, distribution and operating systems with respect to their impact on the health and safety of our employees and the public, as well as their impact on the environment.

It is particular concern to control or eliminate releases of those substances into the atmosphere which are known as ozone depleting substances (ODSs).

The Montreal Protocol (1987) and its London Amendments (1990) intend to severely restrict the use of ODSs and forbid their use within the next ten years. Various national and international initiatives are pressing for an earlier ban on these substances.

Vishay Semiconductor GmbH has been able to use its policy of continuous improvements to eliminate the use of ODSs listed in the following documents.

1. Annex A, B and list of transitional substances of the Montreal Protocol and the London Amendments respectively.
2. Class I and II ozone depleting substances in the Clean Air Act Amendments of 1990 by the Environmental Protection Agency (EPA) in the USA.
3. Council Decision 88/540/EEC and 91/690/EEC Annex A, B and C (transitional substances) respectively.

Vishay Semiconductor GmbH can certify that our semiconductors are not manufactured with ozone depleting substances and do not contain such substances.

We reserve the right to make changes to improve technical design
and may do so without further notice.

Parameters can vary in different applications. All operating parameters must be validated for each customer application by the customer. Should the buyer use Vishay Semiconductors products for any unintended or unauthorized application, the buyer shall indemnify Vishay Semiconductors against all claims, costs, damages, and expenses, arising out of, directly or indirectly, any claim of personal damage, injury or death associated with such unintended or unauthorized use.

Vishay Semiconductor GmbH, P.O.B. 3535, D-74025 Heilbronn, Germany



Disclaimer

All product specifications and data are subject to change without notice.

Vishay Intertechnology, Inc., its affiliates, agents, and employees, and all persons acting on its or their behalf (collectively, "Vishay"), disclaim any and all liability for any errors, inaccuracies or incompleteness contained herein or in any other disclosure relating to any product.

Vishay disclaims any and all liability arising out of the use or application of any product described herein or of any information provided herein to the maximum extent permitted by law. The product specifications do not expand or otherwise modify Vishay's terms and conditions of purchase, including but not limited to the warranty expressed therein, which apply to these products.

No license, express or implied, by estoppel or otherwise, to any intellectual property rights is granted by this document or by any conduct of Vishay.

The products shown herein are not designed for use in medical, life-saving, or life-sustaining applications unless otherwise expressly indicated. Customers using or selling Vishay products not expressly indicated for use in such applications do so entirely at their own risk and agree to fully indemnify Vishay for any damages arising or resulting from such use or sale. Please contact authorized Vishay personnel to obtain written terms and conditions regarding products designed for such applications.

Product names and markings noted herein may be trademarks of their respective owners.