

CD/DVD Player

Operating Instructions

www.DataSheet4U.com



DVP-NS530
DVP-NS730P

www.DataSheet4U.com

WARNING

To prevent fire or shock hazard, do not expose the unit to rain or moisture. To avoid electrical shock, do not open the cabinet. Refer servicing to qualified personnel only. The mains lead must only be changed at a qualified service shop.

CAUTION

The use of optical instruments with this product will increase eye hazard. As the laser beam used in this CD/DVD player is harmful to eyes, do not attempt to disassemble the cabinet. Refer servicing to qualified personnel only.

www.DataSheet4U.com

Precautions

Safety

- The power requirements and power consumption of this unit are indicated on the back of the unit. Check that the unit's operating voltage is identical with your local power supply.

Power requirements and power consumption



- To prevent fire or shock hazard, do not place objects filled with liquids, such as vases, on the apparatus.

Installing

- Do not install the unit in an inclined position. It is designed to be operated in a horizontal position only.
- Keep the unit and discs away from equipment with strong magnets, such as microwave ovens, or large loudspeakers.
- Do not place heavy objects on the unit.

For the model supplied with the AC plug adaptor

If the AC plug of your unit does not fit into the wall outlet, attach the supplied AC plug adaptor.

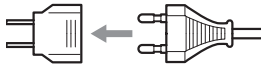

Welcome!

Thank you for purchasing this Sony CD/DVD Player. Before operating this player, please read this manual thoroughly and retain it for future reference.

Precautions

On safety

- Caution – The use of optical instruments with this product will increase eye hazard.
- Should any solid object or liquid fall into the cabinet, unplug the player and have it checked by qualified personnel before operating it any further.

On power sources

- The player is not disconnected from the AC power source (mains) as long as it is connected to the wall outlet, even if the player itself has been turned off.
- If you are not going to use the player for a long time, be sure to disconnect the player from the wall outlet. To disconnect the AC power cord (mains lead), grasp the plug itself; never pull the cord.

On placement

- Place the player in a location with adequate ventilation to prevent heat build-up in the player.
- Do not place the player on a soft surface such as a rug that might block the ventilation holes.
- Do not place the player in a location near heat sources, or in a place subject to direct sunlight, excessive dust, or mechanical shock.

On operation

- If the player is brought directly from a cold to a warm location, or is placed in a very damp room, moisture may condense on the lenses inside the player. Should this occur, the player may not operate properly. In this case, remove the disc and leave the player turned on for about half an hour until the moisture evaporates.
- When you move the player, take out any discs. If you don't, the disc may be damaged.

On adjusting volume

Do not turn up the volume while listening to a section with very low level inputs or no audio signals. If you do, the speakers may be damaged when a peak level section is played.

On cleaning

Clean the cabinet, panel, and controls with a soft cloth slightly moistened with a mild detergent solution. Do not use any type of abrasive pad, scouring powder or solvent such as alcohol or benzine.

On cleaning discs

Do not use a commercially available cleaning disc. It may cause a malfunction.

IMPORTANT NOTICE

Caution: This player is capable of holding a still video image or on-screen display image on your television screen indefinitely. If you leave the still video image or on-screen display image displayed on your TV for an extended period of time you risk permanent damage to your television screen. Plasma Display Panel televisions and projection televisions are susceptible to this.

If you have any questions or problems concerning your player, please consult your nearest Sony dealer.

Table of Contents

WARNING	2
Welcome!	2
Precautions	3
About this Manual	6
This Player Can Play the Following Discs	6
Notes about the Discs	7
Index to Parts and Controls	8
Guide to the Control Menu Display	12
<hr/>	
Hookups	15
Hooking Up the Player	15
Step 1: Unpacking	15
Step 2: Inserting Batteries into the Remote	15
Step 3: Connecting the Video Cords	16
Step 4: Connecting the Audio Cords	19
Step 5: Connecting the Power Cord	24
Step 6: Quick Setup	24
<hr/>	
Playing Discs	27
Playing Discs	27
Resuming Playback From the Point Where You Stopped the Disc (Multi-disc Resume)	29
Using the DVD's Menu	30
Selecting "ORIGINAL" or "PLAY LIST" on a DVD-RW Disc	31
Playing VIDEO CDs With PBC Functions (PBC Playback)	32
Playing an MP3 Audio Track	33
Various Play Mode Functions (Programme Play, Shuffle Play, Repeat Play, A-B Repeat Play)	35
<hr/>	
Searching for a Scene	40
Searching for a Particular Point on a Disc (Scan, Slow-motion Play, Search, Freeze Frame)	40
Searching for a Title/Chapter/Track/Scene, etc.	41
Searching by Scene (PICTURE NAVIGATION)	43
<hr/>	
Viewing Information About the Disc	44
Checking the Playing Time and Remaining Time	44
Checking the Play Information	46
<hr/>	
Sound Adjustments	48
Changing the Sound	48
TV Virtual Surround Settings (TVS)	50

Enjoying Movies	52
Changing the Angles	52
Displaying the Subtitles	52
Adjusting the Picture Quality (BNR)	53
Adjusting the Playback Picture (CUSTOM PICTURE MODE)	54
Enhancing the Playback Picture (DIGITAL VIDEO ENHANCER)	55

Using Various Additional Functions	57
Locking Discs (CUSTOM PARENTAL CONTROL, PARENTAL CONTROL)	57
Controlling Your TV with the Supplied Remote	61

Settings and Adjustments	62
Using the Setup Display	62
Setting the Display or Sound Track Language (LANGUAGE SETUP)	63
Settings for the Display (SCREEN SETUP)	64
Custom Settings (CUSTOM SETUP)	65
Settings for the Sound (AUDIO SETUP)	66

Additional Information	68
Troubleshooting	68
Self-diagnosis Function (When letters/numbers appear in the display)	70
Glossary	71
Specifications	73
Language Code List	74
Index	75





www.DataSheet4U.com

About this Manual

Check your model name





The instructions in this manual are for 2 models: DVP-NS530 and DVP-NS730P. Check your model name by looking at the front panel of the player. DVP-NS530 is the model used for illustration purposes. Any difference in operation is clearly indicated in the text, for example, “DVP-NS730P only.”

- Instructions in this manual describe the controls on the remote. You can also use the controls on the player if they have the same or similar names as those on the remote.
- “DVD” may be used as a general term for DVD VIDEOS, DVD-RWs/DVD-Rs, and DVD+RWs/DVD+Rs.
- Displays on the screen are slightly different depending upon where the model is sold.
- The meaning of the icons used in this manual is described below:

Icon	Meaning
	Functions available for DVD VIDEOS, and DVD-RWs/ DVD-Rs in video mode or DVD+RWs/DVD+Rs
	Functions available for DVD-RWs in VR (Video Recording) mode
	Functions available for VIDEO CDs, Super VCDs, or CD-Rs/ CD-RWs in video CD format or Super VCD format
	Functions available for music CDs or CD-Rs/CD-RWs in music CD format
	Functions available for DATA CDs (CD-ROMs/CD-Rs/CD-RWs containing MP3* audio tracks)

* MP3 (MPEG1 Audio Layer 3) is a standard format defined by ISO/MPEG which compresses audio data.

This Player Can Play the Following Discs

Format of discs	
DVD VIDEO (page 71)	
DVD-RW (page 71)	
VIDEO CD	
Music CD	

“DVD VIDEO” and “DVD-RW” are trademarks.

Region code

Your player has a region code printed on the back of the unit and only will play DVD VIDEO discs (playback only) labelled with identical region codes. This system is used to protect copyrights.

DVD VIDEOS labelled  will also play on this player.

If you try to play any other DVD VIDEO, the message “Playback prohibited by area limitations.” will appear on the TV screen. Depending on the DVD VIDEO, no region code indication may be labelled even though playing the DVD VIDEO is prohibited by area restrictions.



Example of discs that the player cannot play

The player cannot play the following discs:

- All CD-ROMs (including PHOTO CDs)/CD-Rs/CD-RWs other than those recorded in the following formats:
 - music CD format
 - video CD format
 - MP3 format that conforms to ISO9660* Level 1/Level 2, or its extended format, Joliet
 - Data part of CD-Extras
 - DVD-ROMs
 - DVD Audio discs
 - HD layer on Super Audio CDs
- * A logical format of files and folders on CD-ROMs, defined by ISO (International Standard Organization).

Also, the player cannot play the following discs:

- A DVD VIDEO with a different region code.
- A disc that has a non-standard shape (e.g., card, heart).
- A disc with paper or stickers on it.
- A disc that has the adhesive of cellophane tape or a sticker still left on it.

Notes

• Notes about DVD-RWs/DVD-Rs, DVD+RWs/DVD+Rs or CD-Rs/CD-RWs

Some DVD-RWs/DVD-Rs, DVD+RWs/DVD+Rs, or CD-Rs/CD-RWs cannot be played on this player due to the recording quality or physical condition of the disc, or the characteristics of the recording device and authoring software.

The disc will not play if it has not been correctly finalized. Also, images in DVD-RW discs with CPRM* protection may not be played if they contain a copy protection signal. "Copyright lock" appears on the screen. For more information, see the operating instructions for the recording device. Note that discs created in the Packet Write format cannot be played.

* CPRM (Content Protection for Recordable Media) is a coding technology that protects the copyright of images.

• Music discs encoded with copyright protection technologies

This product is designed to playback discs that conform to the Compact Disc (CD) standard. Recently, various music discs encoded with copyright protection technologies are marketed by some record companies. Please be aware that among those discs, there are some that do not

conform to the CD standard and may not be playable by this product.

Note on playback operations of DVDs and VIDEO CDs

Some playback operations of DVDs and VIDEO CDs may be intentionally set by software producers. Since this player plays DVDs and VIDEO CDs according to the disc contents the software producers designed, some playback features may not be available. Also, refer to the instructions supplied with the DVDs or VIDEO CDs.

Copyrights

This product incorporates copyright protection technology that is protected by method claims of certain U.S. patents, other intellectual property rights owned by Macrovision Corporation, and other rights owners. Use of this copyright protection technology must be authorized by Macrovision Corporation, and is intended for home and other limited viewing uses only unless otherwise authorized by Macrovision Corporation. Reverse engineering or disassembly is prohibited.

Notes about the Discs

- To keep the disc clean, handle the disc by its edge. Do not touch the surface.



- Do not expose the disc to direct sunlight or heat sources such as hot air ducts, or leave it in a car parked in direct sunlight as the temperature may rise considerably inside the car.
- After playing, store the disc in its case.
- Clean the disc with a cleaning cloth. Wipe the disc from the centre out.



- Do not use solvents such as benzene, thinner, commercially available anti-static spray intended for vinyl LPs.

Index to Parts and Controls

For more information, refer to the pages indicated in parentheses.

Front panel

DVP-NS530

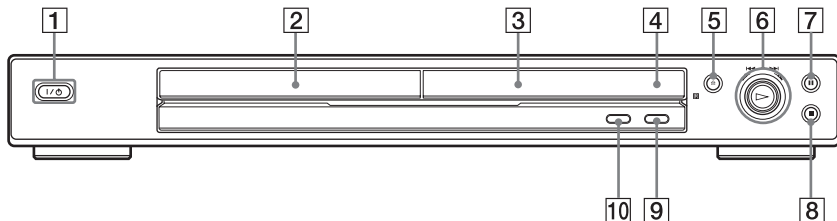

- 1 I/⏻ (on/standby) button (27)
- 2 Disc tray (27)
- 3 Front panel display (9)
- 4 (remote sensor) (15)
- 5 (open/close) button (27)

- 6 Playback Dial (40)
- 7 (pause) button (28)
- 8 (stop) button (28)
- 9 SURROUND button (50)
- 10 PICTURE MODE button (54)

DVP-NS730P

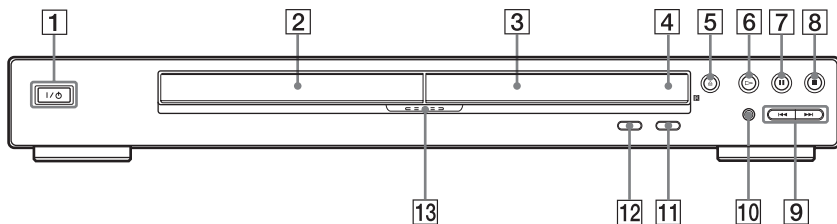

- 1 I/⏻ (on/standby) button (27)
- 2 Disc tray (27)
- 3 Front panel display (9)
- 4 (remote sensor) (15)
- 5 (open/close) button (27)
- 6 (play) button (27)
- 7 (pause) button (28)
- 8 (stop) button (28)

- 9 (previous/next) buttons (40)
- 10 PROGRESSIVE button (18, 24)
- 11 SURROUND button (50)
- 12 PICTURE MODE button (54)
- 13 PROGRESSIVE indicator (17)
Lights up when the player outputs progressive signals.

Front panel display

When playing back a DVD VIDEO/DVD-RW

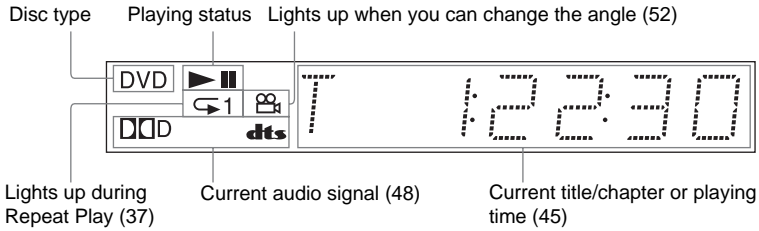

When playing back a VIDEO CD with Playback Control (PBC) (32)

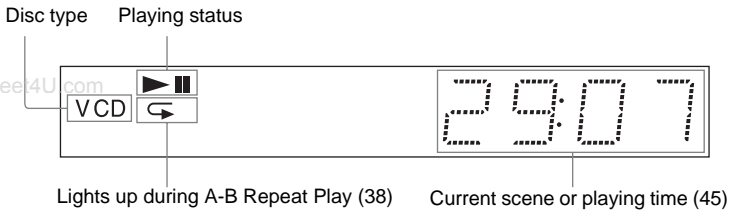

When playing back a CD, DATA CD (MP3 audio), or VIDEO CD (without PBC)

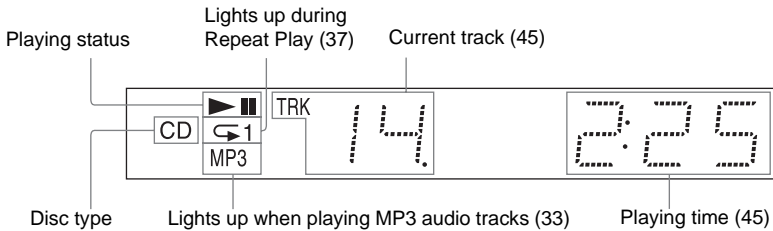

Rear panel

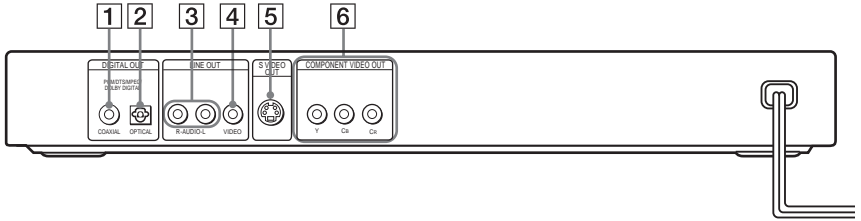

- 1** DIGITAL OUT (COAXIAL) jack (21)
(22) (23)
- 2** DIGITAL OUT (OPTICAL) jack (21)
(22) (23)
- 3** LINE OUT L/R (AUDIO) jacks (20)
(21) (22)
- 4** LINE OUT (VIDEO) jack (16)
- 5** S VIDEO OUT jack (16)
- 6** COMPONENT VIDEO OUT jacks
(16)
- The jack names differ depending on the models.
- DVP-NS530:** Y, C_B, C_R
- DVP-NS730P:** Y, P_B/C_B, P_R/C_R

Remote

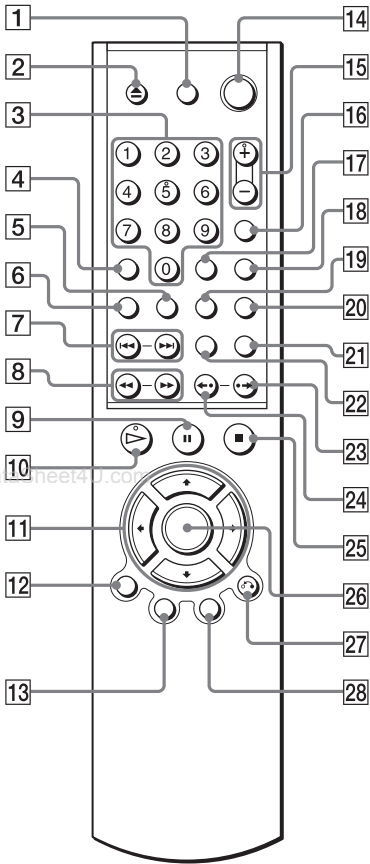

- 1** TV \mathbb{I}/\mathbb{O} (on/standby) button (61)
- 2** \blacktriangle OPEN/CLOSE button (27)
- 3** Number buttons (30)
The number 5 button has a tactile dot.*
- 4** CLEAR button (35)
- 5** SUBTITLE button (52)
- 6** AUDIO button (48)
- 7** $\mathbb{L}\mathbb{L}/\mathbb{R}\mathbb{R}$ PREV/NEXT (previous/next) buttons (28)
- 8** $\mathbb{L}\mathbb{L}\mathbb{L}/\mathbb{R}\mathbb{R}\mathbb{R}$ SCAN/SLOW buttons (40)
- 9** $\mathbb{I}\mathbb{I}$ PAUSE button (28)
- 10** \triangleright PLAY button (27)
The \triangleright button has a tactile dot.*
- 11** $\mathbb{L}/\mathbb{U}/\mathbb{D}/\mathbb{R}$ buttons (30)
- 12** DISPLAY button (12)
- 13** TOP MENU button (30)
- 14** \mathbb{I}/\mathbb{O} (on/standby) button (27)
- 15** VOL (volume) +/- buttons (61)
The + button has a tactile dot.*
- 16** TV/VIDEO button (61)
- 17** TIME/TEXT button (44)
- 18** PICTURE MODE button (54)
- 19** ANGLE button (52)
- 20** SUR (surround) button (50)
- 21** PICTURE NAVI (picture navigation) button (43)
- 22** REPEAT button (37)
- 23** $\bullet\rightarrow/\mathbb{I}\mathbb{I}$ INSTANT SEARCH/STEP button (28, 40)
- 24** $\mathbb{L}\bullet/\mathbb{L}\mathbb{I}$ INSTANT REPLAY/STEP button (28, 40)
- 25** \blacksquare STOP button (28)
- 26** ENTER button (24)
- 27** \mathbb{O} RETURN button (32)
- 28** MENU button (30) (33)

* Use the tactile dot as a reference when operating the player.

Guide to the Control Menu Display

Use the Control Menu to select a function and to view related information. Press DISPLAY repeatedly to turn on or change the Control Menu display as follows:

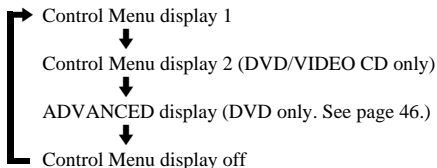

Hint

You can skip the ADVANCED display by setting "OFF" under "ADVANCED" in the Control Menu (page 46).

Control Menu Display

The Control Menu display 1 and 2 will show different items depending on the disc type. For details about each item, please refer to the pages in parentheses.



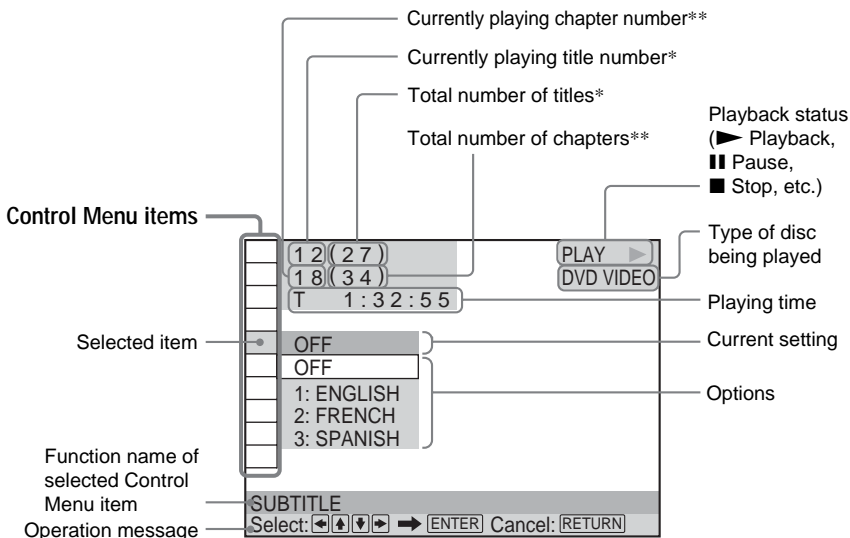











Example: Control Menu display 1 when playing a DVD VIDEO.











* Displays the scene number for VIDEO CDs (PBC is on), track number for VIDEO CDs/CDs, album number for DATA CDs.



** Displays the index number for VIDEO CDs/CDs, MP3 audio track number for DATA CDs.

List of control menu items

Item	Item Name, Function, Relevant Disc Type
	TITLE (page 41)/SCENE (page 41)/TRACK (page 41) Selects the title, scene, or track to be played. DVD-V DVD-RW VCD
	CHAPTER (page 41)/INDEX (page 41) Selects the chapter or index to be played. DVD-V DVD-RW VCD
	ALBUM (page 33) Selects the album to be played. DATA CD
	TRACK (page 41) Selects the track to be played. CD DATA CD
	INDEX (page 41) Selects the index to be played. CD
	ORIGINAL/PLAY LIST (page 31) Selects the type of titles (DVD-RW) to be played, the ORIGINAL one, or an edited PLAY LIST. DVD-RW
	TIME/TEXT (page 41) Checks the elapsed time and the remaining playback time. Input the time code for picture and music searching. Displays the DVD/CD text or the DATA CD's track name. DVD-V DVD-RW VCD CD DATA CD
	AUDIO (page 48) Changes the audio setting. DVD-V DVD-RW VCD CD DATA CD
	SUBTITLE (page 52) Displays the subtitles. Changes the subtitle language. DVD-V DVD-RW
	ANGLE (page 52) Changes the angle. DVD-V
	TVS (TV Virtual Surround) (page 50) Selects the surround functions. DVD-V
	ADVANCED (page 46) Displays the information (bit rate or layer) of the disc currently playing. DVD-V DVD-RW
	PARENTAL CONTROL (page 57) Set to prohibit playback on this player. DVD-V VCD CD
	SETUP (page 62) QUICK Setup (page 24) Use Quick Setup to choose the desired language of the on-screen display, the aspect ratio of the TV, and the audio output signal. CUSTOM Setup In addition to the Quick Setup setting, you can adjust various other settings. RESET Returns the settings in "SETUP" to the default setting. DVD-V DVD-RW VCD CD DATA CD

	PROGRAM (page 35) Selects the title, chapter, or track to play in the order you want. DVD-V VCD CD
	SHUFFLE (page 36) Plays the title, chapter, or track in random order. DVD-V VCD CD
	REPEAT (page 37) Plays the entire disc (all titles/all tracks/all albums) repeatedly or one title/chapter/track/album repeatedly. DVD-V DVD-RW VCD CD DATA CD
	A-B REPEAT (page 38) Specifies the parts you want to play repeatedly. DVD-V DVD-RW VCD CD
	BNR (page 53) Adjusts the picture quality by reducing the “block noise” or mosaic like patterns that appear on your TV screen. DVD-V DVD-RW VCD
	CUSTOM PICTURE MODE (page 54) Adjusts the video signal from the player. You can select the picture quality that best suits the programme you are watching. DVD-V DVD-RW VCD
	DIGITAL VIDEO ENHANCER (page 55) Exaggerates the outline of the image to produce a sharper picture. DVD-V DVD-RW VCD
	PICTURE NAVIGATION (page 43) Divides the screen into 9 subscreens to help you find the scene you want quickly. DVD-V VCD

Hint

The Control Menu icon indicator lights up in green  →  when you select any item except “OFF.” (“TVS,” “PROGRAM,”

“SHUFFLE,” “REPEAT,” “A-B REPEAT,” “BNR,” “DIGITAL VIDEO ENHANCER” only).

The “ANGLE” indicator lights up in green only when the angles can be changed. The “CUSTOM PICTURE MODE” indicator lights up in green when any setting other than “STANDARD” is selected.

Hooking Up the Player

Follow Steps 1 to 6 to hook up and adjust the settings of the player.

Notes

- Plug cords securely to prevent unwanted noise.
- Refer to the instructions supplied with the components to be connected.
- You cannot connect this player to a TV that does not have a video input jack.
- Be sure to disconnect the power cord (mains lead) of each component before connecting.

Step 1: Unpacking

Check that you have the following items:

- Audio/video cord (pinplug $\times 3 \leftrightarrow$ pinplug $\times 3$) (1)
- Remote commander (remote) (1)
- R6 (size AA) batteries (2)
- A plug adaptor is included with some models.

Step 2: Inserting Batteries into the Remote

You can control the player using the supplied remote. Insert two R6 (size AA) batteries by matching the \oplus and \ominus ends on the batteries to the markings inside the compartment. When using the remote, point it at the remote sensor  on the player.

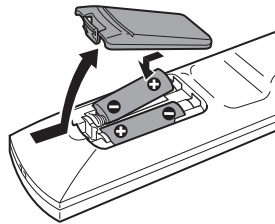

Notes

- Do not leave the remote in an extremely hot or humid place.
- Do not drop any foreign object into the remote casing, particularly when replacing the batteries.
- Do not expose the remote sensor to direct light from the sun or a lighting apparatus. Doing so may cause a malfunction.
- If you do not use the remote for an extended period of time, remove the batteries to avoid possible damage from battery leakage and corrosion.

Step 3: Connecting the Video Cords

Connect this player to your TV monitor, projector, or AV amplifier (receiver) using a video cord. Select one of the patterns **A** through **C**, according to the input jack on your TV monitor, projector, or AV amplifier (receiver).

For DVP-NS730P only

In order to view progressive signal (525p or 625p) pictures with a compatible TV, projector, or monitor, you must use connection **C**.

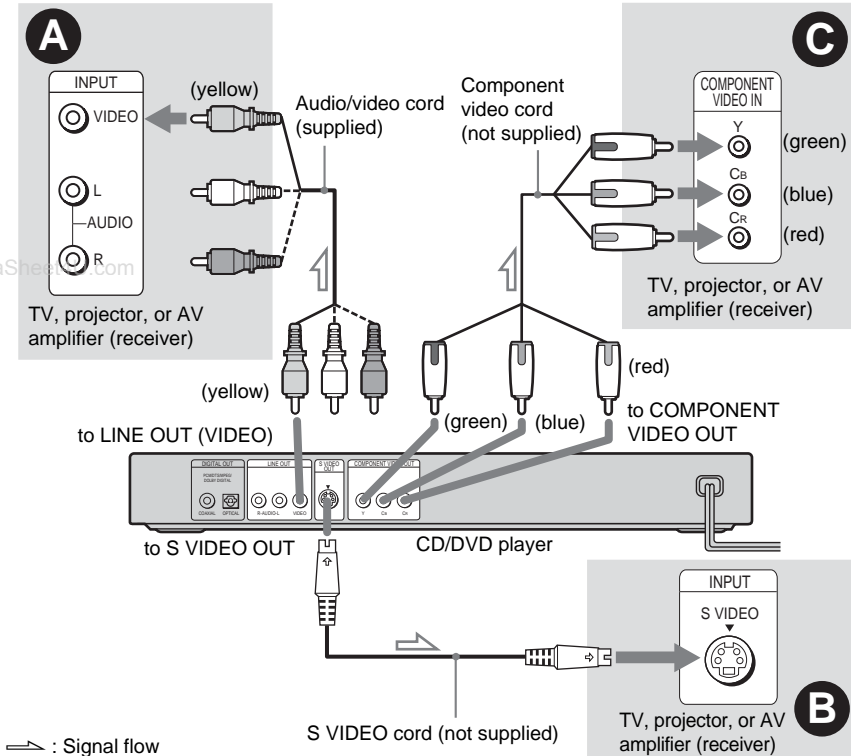

A If you are connecting to a video input jack

Connect the yellow plug of the audio/video cord (supplied) to the yellow (video) jacks. You will enjoy standard quality images.

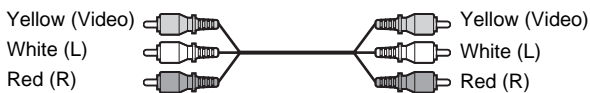

Use the red and white plugs to connect to the audio input jacks (page 20). (Do this if you are connecting to a TV only.)

B If you are connecting to an S VIDEO input jack

Connect the S VIDEO cord (not supplied). You will enjoy high quality images.



C If you are connecting to a monitor, projector, or AV amplifier (receiver) having component video input jacks (Y, C_B, C_R or Y, P_B/C_B, P_R/C_R)

Connect the component via the COMPONENT VIDEO OUT jacks using a component video cord (not supplied) or three video cords (not supplied) of the same kind and length. You will enjoy accurate colour reproduction and high quality images.

For DVP-NS730P only

If your TV accepts progressive 525p/625p format signals, you must use this connection and then press PROGRESSIVE on the front panel to accept progressive video signals. The PROGRESSIVE indicator lights up in blue when the player outputs progressive signals. See “Using the PROGRESSIVE button” on the next page for more information.

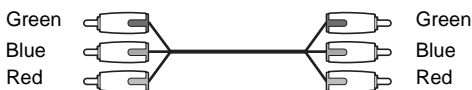

When connecting to a standard 4:3 screen TV

Depending on the disc, the image may not fit your TV screen. If you want to change the aspect ratio, please refer to page 64.

To change the colour system

The colour system of the player is set to NTSC or PAL. If the on-screen display of the player does not appear on the TV, change the colour system of the player (PAL or NTSC) so that a picture appears on your TV. To change the colour system, hold down for a few seconds while pressing **II** on the player.

Notes

- Do not connect the player to a VCR. If you pass the player signals via the VCR, you may not receive a clear image on the TV screen. If your TV only has one audio/video input jack, connect the player to this jack.

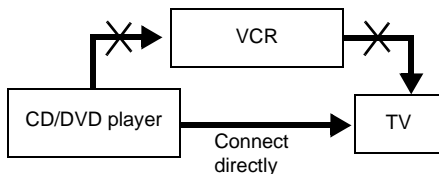

For DVP-NS730P only

- Consumers should note that not all high definition television sets are fully compatible with this product and may cause artifacts to be displayed in the picture. In the case of progressive scan picture problems, it is recommended that you switch the connection to the standard definition output. If there are questions regarding your Sony TV set's compatibility with this DVD player, please contact our customer service centre.

Using the PROGRESSIVE button (DVP-NS730P only)

You can fine-tune the Progressive 525p/625p video signal output when you press PROGRESSIVE on the front panel (the PROGRESSIVE indicator lights up in blue) and connect the player using the COMPONENT VIDEO OUT jacks to a TV that is able to accept the video signal in progressive format.

◆ Conversion Modes

DVD software can be divided into two types: film based software and video based software. Video based software is derived from the TV, such as dramas and sit-coms, and displays images at 30 frames/60 fields (25 frames/50 fields) per second. Film based software is derived from film and displays images at 24 frames per second. Some DVD software contains both Video and Film.

In order for these images to appear natural on your screen when output in PROGRESSIVE mode (60 frames or 50 frames per second), the progressive video signal needs to be converted to match the type of DVD software that you are watching.

Press PROGRESSIVE repeatedly to turn or change the displays as follows:

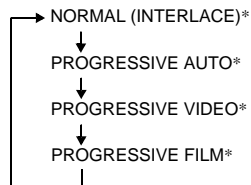

* Appears as NORMAL, P AUTO, P VIDEO, or P FILM on the front panel display. “(NTSC)” appears when the signal can only be output in NTSC format.

• NORMAL (INTERLACE)

Select this when you are connected to a standard (Interlace format) TV.

• PROGRESSIVE AUTO

Select this when you are connected to a progressive TV. This will automatically detect if you are playing Film based or Video based software and convert the signal to the appropriate conversion mode.

Normally select this position when you are connected to a progressive TV.

• PROGRESSIVE VIDEO

Select this when you are connected to a progressive TV. This will set the conversion mode for Video based software, regardless of the type of software that you are playing.

• PROGRESSIVE FILM

Select this when you are connected to a progressive TV. This will set the conversion mode for Film based software, regardless of the type of software that you are playing.

Notes

- When you select PROGRESSIVE FILM, the progressive format images may become unclear or unnatural. If this happens, select PROGRESSIVE VIDEO.
- When you play video based software with progressive signals, sections of some types of images may appear unnatural due to the conversion process when output through the COMPONENT VIDEO OUT jacks. Images from the S VIDEO OUT and LINE OUT (VIDEO) jacks are unaffected as they are output in the normal (interlace) format.

Step 4: Connecting the Audio Cords

Refer to the chart below to select the connection that best suits your system. Be sure to also read the instructions for the components you wish to connect.

Select a connection

Select one of the following connections, **A** through **D**.

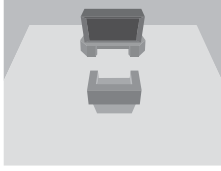
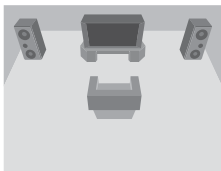
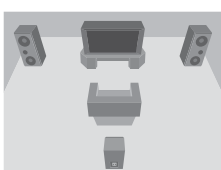
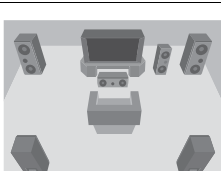
Components to be connected	Connection	Your setup (example)
TV • Surround effects: TVS DYNAMIC (page 50), TVS WIDE (page 50)	A (page 20)	
Stereo amplifier (receiver) and two speakers • Surround effects: TVS STANDARD (page 50) or MD deck/DAT deck • Surround effects: TVS STANDARD (page 50).	B (page 21)	
AV amplifier (receiver) having a Dolby* Surround (Pro Logic) decoder and 3 to 6 speakers • Surround effects: Dolby Surround (Pro Logic) (page 71)	C (page 22)	
AV amplifier (receiver) with digital input jacks having a Dolby Digital, DTS**, or MPEG audio decoder and 6 speakers • Surround effects: – Dolby Digital (5.1ch) (page 71) – DTS (5.1ch) (page 71) – MPEG audio (5.1 ch) (page 72)	D (page 23)	

* Manufactured under license from Dolby Laboratories. "Dolby," "Pro Logic," and the double-D symbol are trademarks of Dolby Laboratories.

** "DTS" and "DTS Digital Out" are trademarks of Digital Theater Systems, Inc.

A Connecting to your TV

This connection will use your TV speakers for sound.

CD/DVD player

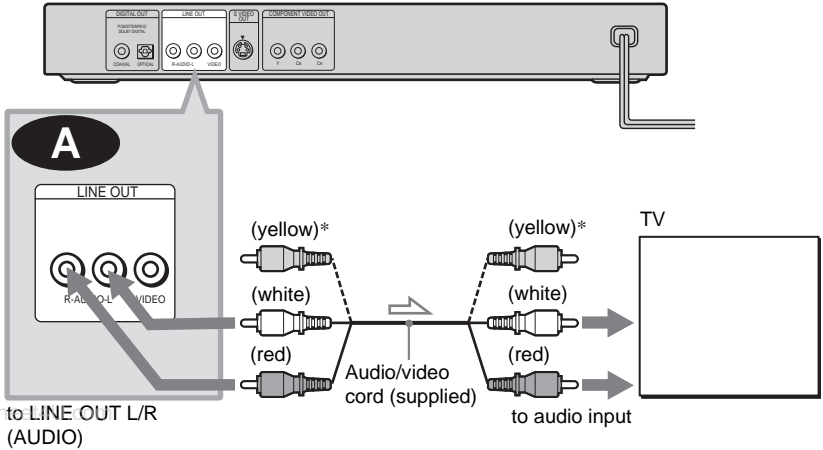

➡ : Signal flow

* The yellow plug is used for video signals (page 16).

💡 Hint

When connecting to a monaural TV, use a stereo-mono conversion cord (not supplied). Connect the LINE OUT L/R (AUDIO) jacks to the TV's audio input jack.

B Connecting to a stereo amplifier (receiver) and 2 speakers/Connecting to an MD deck or DAT deck

If the stereo amplifier (receiver) has audio input jacks L and R only, use **B-1**. If the amplifier (receiver) has a digital input jack, or when connecting to an MD deck or DAT deck, use **B-2**. In this case, you can also connect the player directly to the MD deck or DAT deck without using your stereo amplifier (receiver).

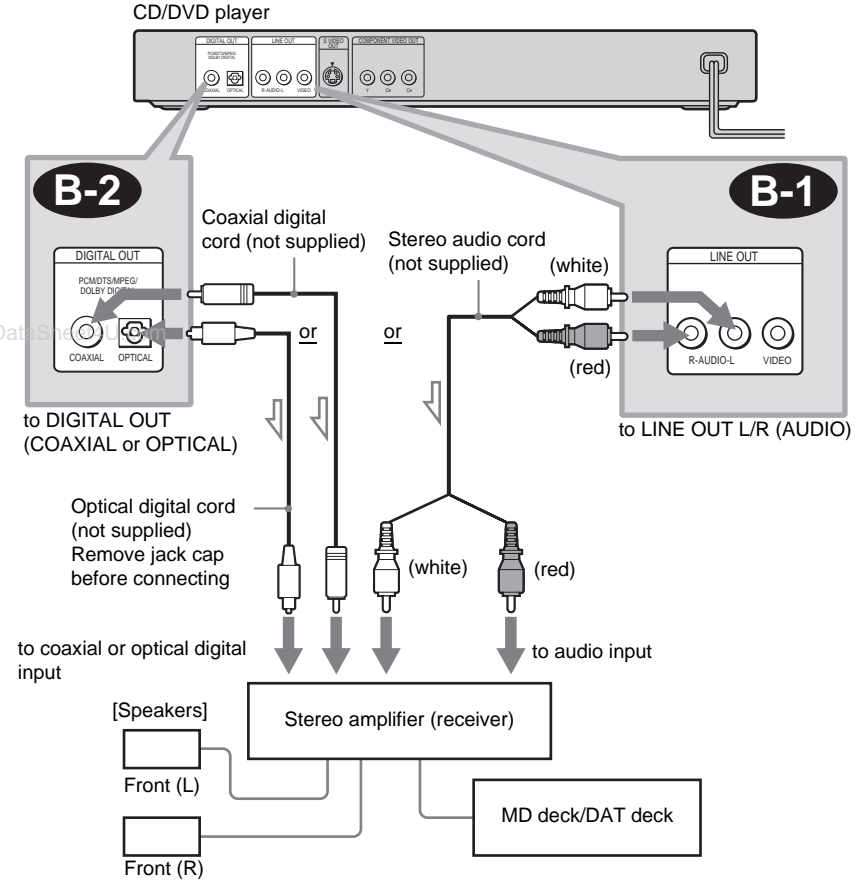

⇒ : Signal flow

C Connecting to an AV amplifier (receiver) having a Dolby Surround (Pro Logic) decoder and 3 to 6 speakers

You can enjoy the Dolby Surround effects only when playing Dolby Surround audio or multi-channel audio (Dolby Digital) discs.

If your amplifier (receiver) has L and R audio input jacks only, use **C-1**. If your amplifier (receiver) has a digital input jack, use **C-2**.

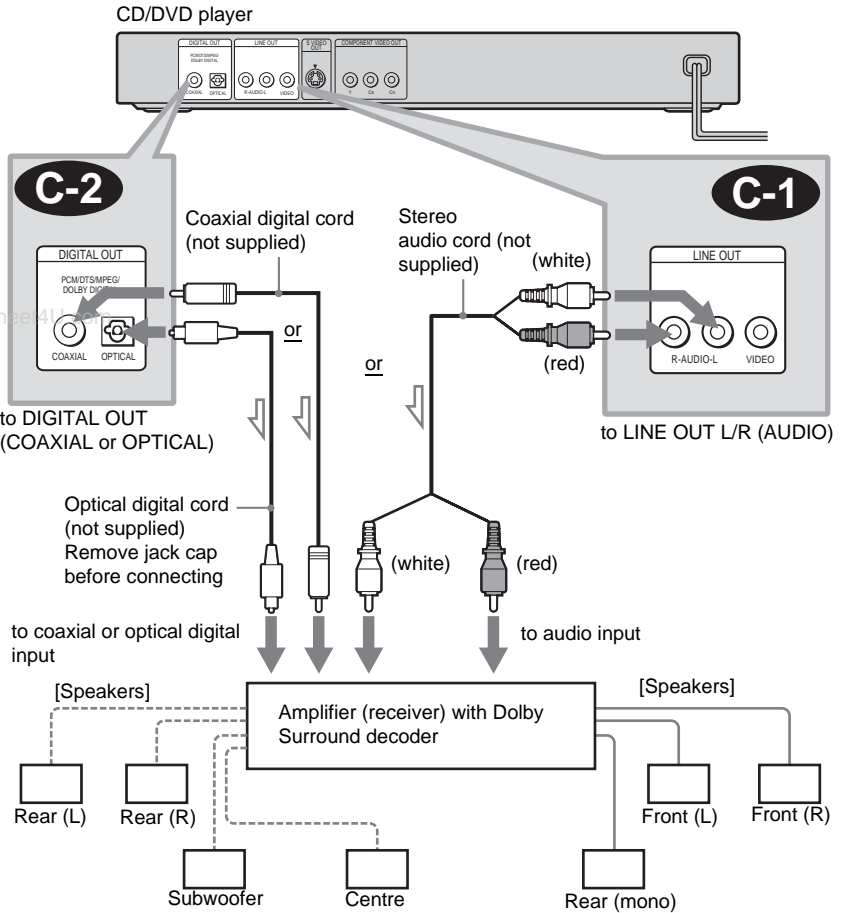

→: Signal flow

Note

When connecting 6 speakers, replace the monaural rear speaker with a centre speaker, 2 rear speakers and a subwoofer.

D Connecting to an AV amplifier (receiver) with a digital input jack having a Dolby Digital, MPEG audio or DTS decoder and 6 speakers

This connection will allow you to use the Dolby Digital, MPEG audio, or DTS decoder function of your AV amplifier (receiver).

CD/DVD player

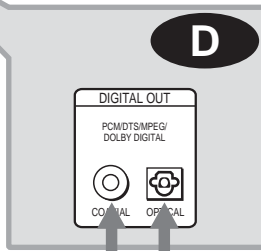

to DIGITAL OUT
(COAXIAL or OPTICAL)

Coaxial digital cord
(not supplied)

or

Optical digital cord
(not supplied)
Remove jack cap
before connecting

to coaxial digital input

to optical digital input

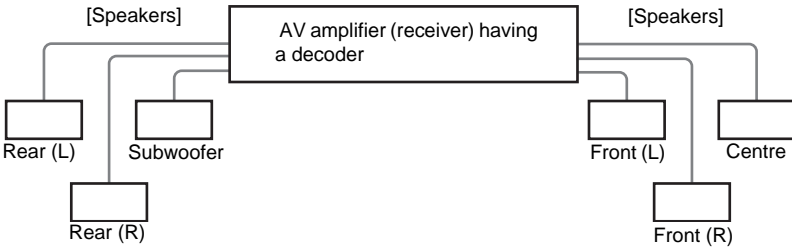

→: Signal flow

Note

After you have completed the connection, be sure to set "DOLBY DIGITAL" to "DOLBY DIGITAL" and "DTS" to "ON" in Quick Setup (page 24). If your AV amplifier (receiver) has an MPEG audio decoder function, set "MPEG" to "MPEG" (page 67). Otherwise, no sound or a loud noise will come from the speakers.

Step 5: Connecting the Power Cord

Plug the player and TV power cord (mains lead) into an AC outlet (mains).

Step 6: Quick Setup

Follow the steps below to make the minimum number of basic adjustments for using the player. To skip an adjustment, press **▶▶**. To return to the previous adjustment, press **◀◀**. The on-screen display differ depending on the player model.

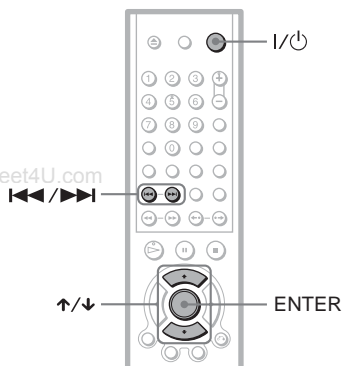

1 Turn on the TV.

2 Press I/⏻.

For DVP-NS730P only

Press PROGRESSIVE on the front panel only if you have made video connection **C** (page 16) and wish to view progressive video signals. The PROGRESSIVE indicator lights up in blue when the player outputs progressive signals.

3 Switch the input selector on your TV so that the signal from the player appears on the TV screen.

“Press [ENTER] to run QUICK SETUP” appears at the bottom of the screen. If this message does not appear, select “QUICK” under “SETUP” in the Control Menu to run Quick Setup (page 63).

4 Press ENTER without inserting a disc.

The Setup Display for selecting the language used in the on-screen display appears. The available languages differ depending upon the player model.

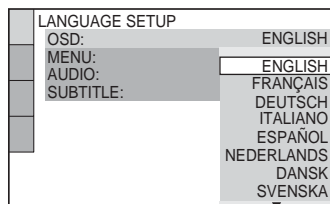

5 Press **↑/↓** to select a language.

The player uses the language selected here to display the menu and subtitles as well.

6 Press ENTER.

The Setup Display for selecting the aspect ratio of the TV to be connected appears.

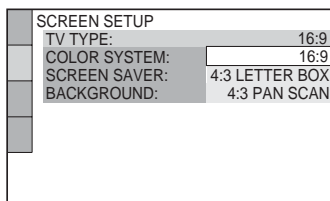

7 Press **↑/↓** to select the setting that matches your TV type.

◆ If you have a wide-screen TV or a 4:3 standard TV with a wide-screen mode • 16:9 (page 64)

- ◆ If you have a 4:3 standard TV
- 4:3 LETTER BOX or 4:3 PAN SCAN (page 64)

8 Press ENTER.

The Setup Display for selecting the type of jack used to connect your amplifier (receiver) appears.

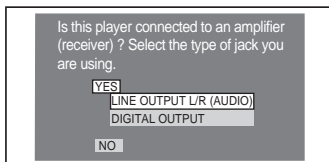

9 Press \uparrow/\downarrow to select the type of jack (if any) you are using to connect to an amplifier (receiver), then press ENTER.

Choose the item that matches the audio connection you selected on pages 20 to 23 (**A** through **D**).

- If you connect just a TV and nothing else, select "NO." Quick Setup is finished and connections are complete.

B-1 **C-1**

- Select "LINE OUTPUT L/R (AUDIO)." Quick Setup is finished and connections are complete.

B-2 **C-2** **D**

- Select "DIGITAL OUTPUT." The Setup Display for "DOLBY DIGITAL" appears.

10 Press \uparrow/\downarrow to select the type of Dolby Digital signal you wish to send to your amplifier (receiver).

Choose the signal that matches the audio connection you selected on pages 21 to 23 (**B** through **D**).

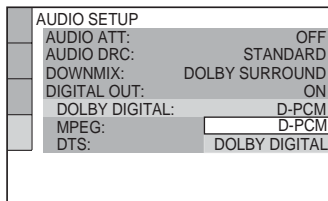

B-2 **C-2**

- D-PCM (page 67)

D

- DOLBY DIGITAL (only if the amplifier (receiver) has a Dolby Digital decoder) (page 67)

11 Press ENTER.

"DTS" is selected.

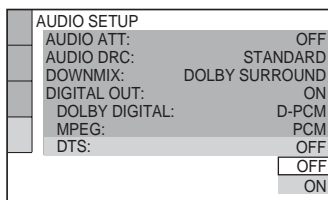

12 Press \uparrow/\downarrow to select whether or not you wish to send a DTS signal to your amplifier (receiver).

Choose the item that matches the audio connection you selected on pages 21 to 23 (**B** through **D**).

B-2 **C-2**

- OFF (page 67)

D

- ON (only if the amplifier (receiver) has a DTS decoder) (page 67)

13 Press ENTER.

Quick Setup is finished. All connections and setup operations are complete.

If your AV amplifier (receiver) has an MPEG audio decoder, set "MPEG" to "MPEG" (page 67).

Enjoying the surround sound effects

To enjoy the surround sound effects of this player or your amplifier (receiver), set the following items as described below for the audio connection you selected on pages 21 to 23 (**B** through **D**). Each of these is the default setting and does not need to be adjusted when you first connect the player. Refer to page 62 for using the Setup Display.

Audio Connection (pages 20 to 23)

A

- No additional settings are needed.

B-1

C-1

- Set “DOWNMIX” to “DOLBY SURROUND” (page 66)
- If the sound distorts even when the volume is turned down, set “AUDIO ATT” to “ON” (page 66)

B-2

C-2

D

- Set “DOWNMIX” to “DOLBY SURROUND” (page 66)
- Set “DIGITAL OUT” to “ON” (page 66)

Playing Discs

Playing Discs DVD-V

DVD-RW VCD CD DATA CD

Depending on the DVD or VIDEO CD, some operations may be different or restricted. Refer to the operating instructions supplied with your disc.

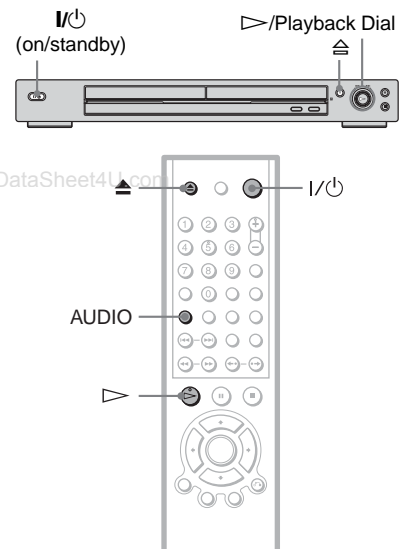

- 1 Turn on your TV.
- 2 Press I/O.
The player turns on.
- 3 Switch the input selector on your TV so that the signal from the player appears on the TV screen.
 - ◆ When using an amplifier (receiver)
Turn on the amplifier (receiver) and select the appropriate channel so that you can hear sound from the player.

- 4 Press \triangle on the player, and place a disc on the disc tray.

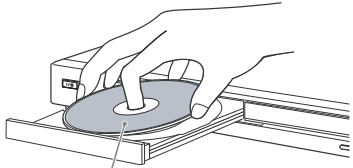

With the playback side facing down

- 5 Press ▷.
 - The disc tray closes, and the player starts playback (continuous play). Adjust the volume on the TV or the amplifier (receiver).
 - Depending on the disc, a menu may appear on the TV screen. For DVD VIDEOS, see page 30. For VIDEO CDs, see page 32.

To turn off the player
Press I/O. The player enters standby mode.

Hint
For DVP-NS730P only
 The player will turn off automatically whenever you leave it in stop mode for more than 30 minutes (Auto Power Off function).
For DVP-NS530 only
 You can have the player turn off automatically whenever you leave it in stop mode for more than 30 minutes. To turn on this function, set "AUTO POWER OFF" in "CUSTOM SETUP" to "ON" (page 65).

- Notes on playing DTS sound tracks on a CD**
- When playing DTS-encoded CDs, excessive noise will be heard from the analog stereo jacks. To avoid possible damage to the audio system, the consumer should take proper precautions when the analog stereo jacks of the player are connected to an amplification system. To enjoy DTS Digital Surround™ playback, an external 5.1-channel decoder system must be connected to the digital jack of the player.
 - Set the sound to "STEREO" using the AUDIO button when you play DTS sound tracks on a CD (page 48).

- Do not play DTS sound tracks without first connecting the player to an audio component having a built-in DTS decoder. The player outputs the DTS signal via the DIGITAL OUT (COAXIAL or OPTICAL) jack even if “DTS” in “AUDIO SETUP” is set to “OFF” in the Setup Display (page 67), and may affect your ears or cause your speakers to be damaged.

Notes on playing DTS sound tracks on a DVD VIDEO

- DTS audio signals are output only through the DIGITAL OUT (COAXIAL or OPTICAL) jack.
- When you play a DVD VIDEO with DTS sound tracks, set “DTS” to “ON” in “AUDIO SETUP” (page 67).
- If you connect the player to audio equipment without a DTS decoder, do not set “DTS” to “ON” in “AUDIO SETUP” (page 67). A loud noise may come out from the speakers, affecting your ears or causing the speakers to be damaged.

Additional operations

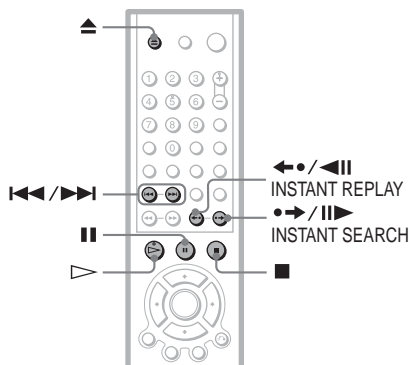

To	Operation
Stop	Press ■
Pause	Press ■■
Resume play after pause	Press ■■ or ▷
Go to the next chapter, track, or scene in continuous play mode	Press ▷▶ or briefly turn the Playback Dial* on the player clockwise (DVP-NS530 only)

To	Operation
Go back to the previous chapter, track, or scene in continuous play mode	Press ◀◀ or briefly turn the Playback Dial* on the player counterclockwise (DVP-NS530 only)
Stop play and remove the disc	Press ▲
Replay the previous scene**	Press ◀●/◀◀ INSTANT REPLAY during playback
Briefly fast forward the current scene***	Press ●▶/▶▶ INSTANT SEARCH during playback

- * For more details about the Playback Dial, see page 40. (DVP-NS530 only)
- ** For DVD VIDEOS and the DVD-RWs/DVD-Rs only
- *** For DVD VIDEOS and the DVD-RWs/DVD-Rs or DVD+RWs only

Hints

- The Instant Replay function is useful when you want to review a scene or dialog that you missed.
- The Instant Search function is useful when you want to pass over a scene that you don't want to watch.

Note

You may not be able to use the Instant Replay or Instant Search function with some scenes.

Locking the disc tray (Child Lock)

You can lock the disc tray to prevent children from opening it.

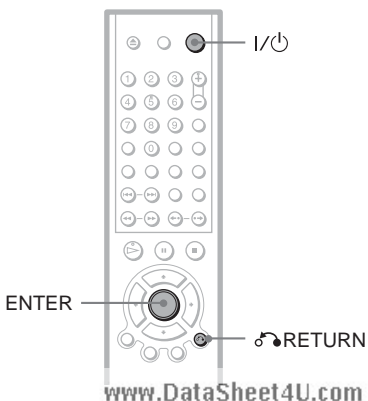

When the player is in standby mode, press **RETURN**, **ENTER**, and then **I/⏻** on the remote.

The player turns on and “LOCKED” appears on the front panel display. The **▲** button on the player or the remote does not work while the Child Lock is set.

To unlock the disc tray

When the player is in standby mode, press **RETURN**, **ENTER**, and then **I/⏻** again.

Note

Even if you select “RESET” under “SETUP” in the Control Menu (page 63), the disc tray remains locked.

www.DataSheet4U.com

Resuming Playback From the Point Where You Stopped the Disc (Multi-disc Resume)

DVD-V **VCD**

The player stores the point where you stopped the disc for up to 6 discs and resumes playback the next time you insert the same disc. When you store a resume playback point for the seventh disc, the resume playback point for the first disc is deleted.

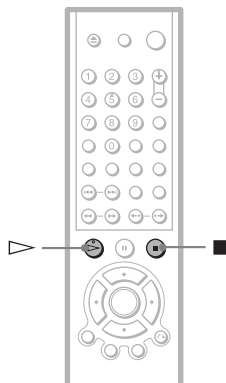

- 1 While playing a disc, press **■** to stop playback.

“RESUME” appears on the front panel display.

- 2 Press **▷**.

The player starts playback from the point where you stopped the disc in step 1.

💡 Hints

- To play from the beginning of the disc, press **■** twice, then press **▷**.
- For DVD-RWs in VR mode, CDs, and DATA CDs, the player remembers the resume playback point for the current disc unless the disc tray is opened, the power cord (mains lead) is disconnected, or only for DATA CDs, the player enters standby mode.

Notes

- “MULTI-DISC RESUME” in “CUSTOM SETUP” must be set to “ON” (default) for this function to work (page 65).
- The resume playback point for the current disc is cleared when:
 - you change the play mode.
 - you change the settings on the Setup Display.
- This function may not work with some discs.
- Resume Play does not work during Shuffle Play and Programme Play.
- If “MULTI-DISC RESUME” in “CUSTOM SETUP” is set to “ON” and you playback a recorded disc such as DVD-RW, the player may playback other recorded discs from the same resume point. To play from the beginning, press **■** twice and then press **▷**.

www.DataSheet4U.com

Using the DVD's Menu

DVD-V

A DVD is divided into long sections of a picture or a music feature called “titles.” When you play a DVD which contains several titles, you can select the title you want using the TOP MENU button. When you play DVDs that allow you to select items such as the language for the subtitles and the language for the sound, select these items using the MENU button.

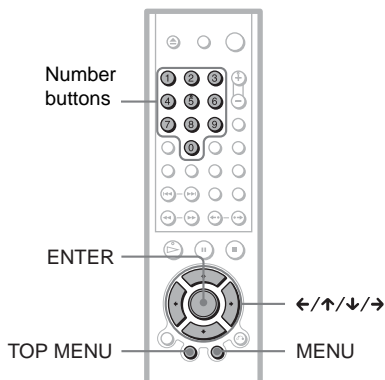

1 Press TOP MENU or MENU.

The disc's menu appears on the TV screen.

The contents of the menu vary from disc to disc.

2 Press ←/↑/↓/→ or the number buttons to select the item you want to play or change.

If you press the number buttons, the following display appears. Press the number buttons to select the item you want.

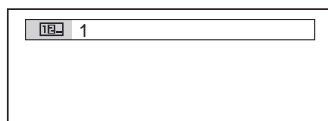

3 Press ENTER.

www.DataSheet4U.com

Selecting "ORIGINAL" or "PLAY LIST" on a DVD-RW Disc **DVD-RW**

Some DVD-RW discs in VR (Video Recording) mode have two types of titles for playback: originally recorded titles (ORIGINAL) and titles that can be created on recordable DVD players for editing (PLAY LIST). You can select the type of titles to be played.

- 3 Press **↑/↓** to select the setting.
 - PLAY LIST: plays the titles created from "ORIGINAL" for editing.
 - ORIGINAL: plays the titles originally recorded.
- 4 Press **ENTER**.

To turn off the Control Menu
 Press **DISPLAY** repeatedly until the Control Menu is turned off.

www.DataSheet4U.com

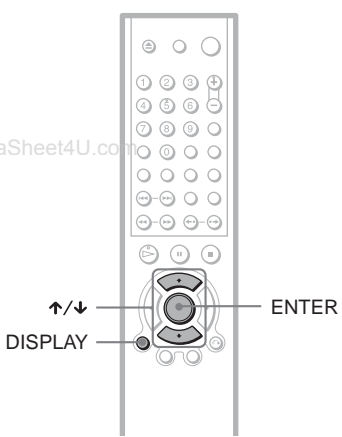

- 1 Press **DISPLAY** in stop mode.
 The Control Menu appears.
- 2 Press **↑/↓** to select (ORIGINAL/PLAY LIST), then press **ENTER**.
 The options for "ORIGINAL/PLAY LIST" appear.

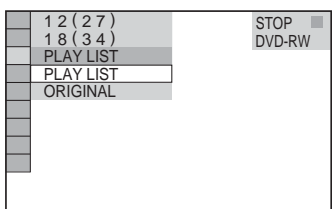

Playing VIDEO CDs With PBC Functions (PBC Playback)

VCD

PBC (Playback Control) allows you to play VIDEO CDs interactively by following the menu on the TV screen.

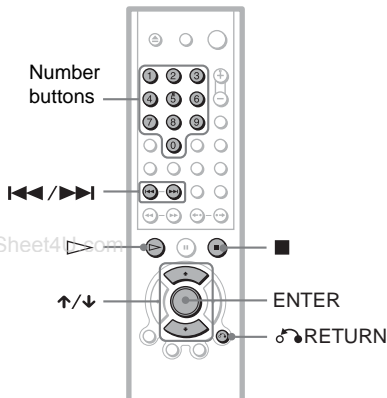

1 Start playing a VIDEO CD with PBC functions.

The menu for your selection appears.

2 Select the item number you want by pressing \uparrow/\downarrow or the number buttons.

3 Press ENTER.

4 Follow the instructions in the menu for interactive operations.

Refer to the instructions supplied with the disc, as the operating procedure may differ depending on the VIDEO CD.

To return to the menu

Press \curvearrowright RETURN.

Hint

To play without using PBC, press \lll/\ggg or the number buttons while the player is stopped to select a track, then press \triangleright or ENTER.

“Play without PBC” appears on the TV screen and the player starts continuous play. You cannot play still pictures such as a menu.

To return to PBC playback, press \blacksquare twice then press \triangleright .

Notes

- Depending on the VIDEO CD, “Press ENTER” in step 3 may appear as “Press SELECT” in the instructions supplied with the disc. In this case, press \triangleright .
- The PBC functions of Super VCDs do not work with this player. Super VCDs are played in continuous play mode only.

Playing an MP3 Audio Track **DATA CD**

You can play back DATA CDs (CD-ROMs/CD-Rs/CD-RWs) recorded in MP3 (MPEG 1 Audio Layer 3) format.

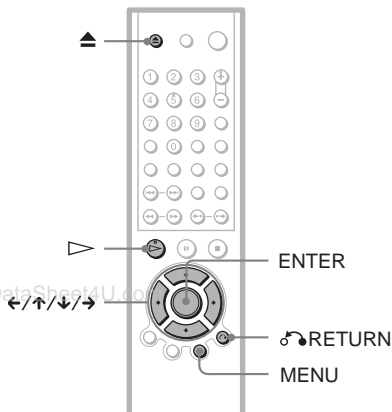

1 Press **▲** and place a DATA CD on the disc tray.

2 Press **▷**.

The disc tray closes, and the player starts to play the first MP3 audio track in the first album on the disc.

Notes

- This player can play MP3 audio tracks recorded in the following sampling frequencies: 32kHz, 44.1kHz, 48kHz.
- The playback order may be different from the edited order. See “The playback order of MP3 audio tracks” on the next page for details.

Selecting an album and track

1 Press **MENU**.

The list of MP3 albums recorded on the DATA CD appears.

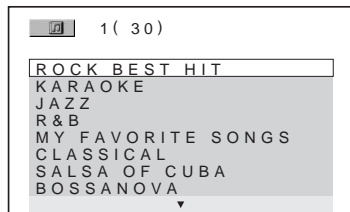

2 Select an album using **↑/↓** and press **ENTER**.

The list of tracks contained in the album appears.

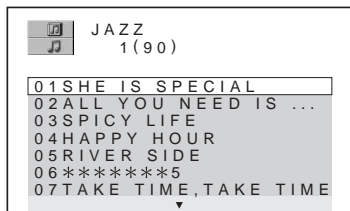

3 Select a track using **↑/↓** and press **ENTER**.

The selected track starts playing. When a track or album is being played, its title is shaded.

To go to the next or previous page

Press **→** or **←**.

To return to the previous display

Press **↶** RETURN.

To turn off the display

Press **MENU**.

Notes

- Only the letters in the alphabet and numbers can be used for album or track names. Anything else is displayed as an “*”.
- ID3 tags cannot be displayed.

About MP3 audio tracks

You can play MP3 audio tracks on CD-ROMs or CD-Rs/CD-RWs. However, the discs must be recorded according to ISO9660 level 1, level 2, or Joliet format for the player to recognize the tracks.

You can also play discs recorded in Multi Session.

www.DataSheet4U.com

See the instructions of the CD-R/CD-RW device or recording software (not supplied) for details on the recording format.

To play a Multi Session CD

This player can play Multi Session CDs when an MP3 audio track is located in the first session. Any subsequent MP3 audio track, recorded in later sessions, can also be played back.

When audio tracks and images in music CD format or video CD format are recorded in the first session, only the first session will be played back.

Notes

- If you put the extension “.MP3” to data not in MP3 format, the player cannot recognize the data properly and will generate a loud noise which could damage your speaker system.
- The player cannot play audio tracks in MP3PRO format.

The playback order of MP3 audio tracks

The playback order of albums and tracks recorded on a DATA CD is as follows.

◆Structure of disc contents

Tree 1 Tree 2 Tree 3 Tree 4 Tree 5

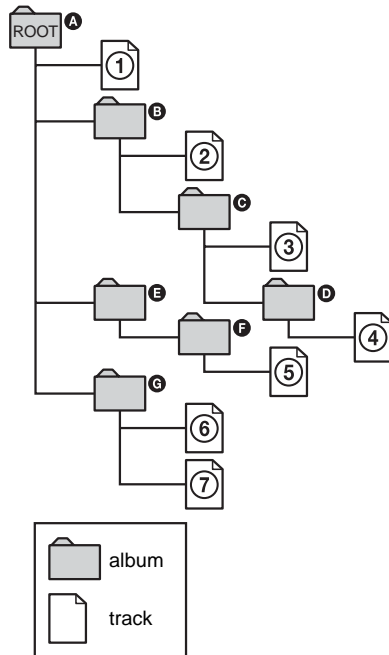

When you insert a DATA CD and press \triangleright , the numbered tracks are played sequentially, from ① through ⑦. Any sub-albums/tracks contained within a currently selected album take priority over the next album in the same tree. (Example: C contains D so ④ is played before ⑤.)

When you press MENU and the list of MP3 albums appears (page 33), the albums are arranged in the following order: A → B → C → D → F → G. Albums that do not contain tracks (such as album E) do not appear in the list.

💡 Hints

- If you add numbers (01, 02, 03, etc.) to the front of the track file names, the tracks will be played in that order.
- Since a disc with many trees takes longer to start playback, it is recommended that you create albums of no more than two trees.

Notes

- Depending on the software you use to create the DATA CD, the playback order may differ from the illustration above.
- The playback order above may not be applicable if there are more than a total of 999 albums and tracks in the DATA CD.
- The player can recognize up to 499 albums (the player will count just albums, including albums that do not contain MP3 audio tracks). The player will not play any albums beyond the first 499 albums. Of the first 499 albums, the player will play no more than a combined total of 999 albums and tracks.

Various Play Mode Functions (Programme Play, Shuffle Play, Repeat Play, A-B Repeat Play)

You can set the following play modes:

- Programme Play (page 35)
- Shuffle Play (page 36)
- Repeat Play (page 37)
- A-B Repeat Play (page 38)

Note

The play mode is cancelled when:
 – you open the disc tray.
 – the player enters standby mode by pressing I/⏻.

Creating your own programme (Programme Play) DVD-V VCD CD

You can play the contents of a disc in the order you want by arranging the order of the titles, chapters, or tracks on the disc to create your own programme. You can programme up to 99 titles, chapters, and tracks.

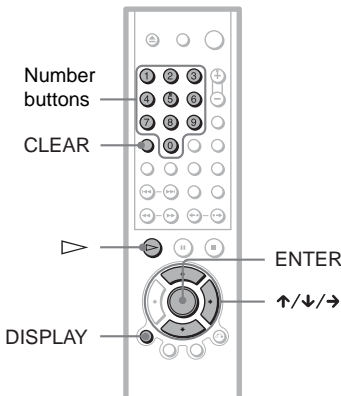

1 Press DISPLAY twice (when playing a CD, press once).
 The Control Menu appears.

2 Press \uparrow/\downarrow to select  (PROGRAM), then press ENTER.
 The options for “PROGRAM” appear.

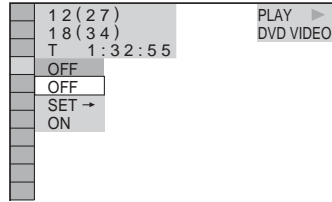

3 Press \uparrow/\downarrow to select “SET \rightarrow ,” then press ENTER.

“TRACK” is displayed when you play a VIDEO CD or CD.

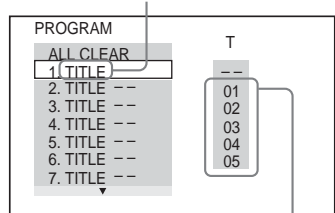

Titles or tracks recorded on a disc

4 Press \rightarrow .

The cursor moves to the title or track row “T” (in this case, “01”).

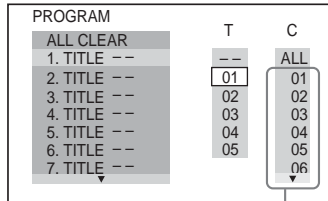

Chapters recorded on a disc

5 Select the title, chapter, or track you want to programme.

◆ When playing a DVD VIDEO

For example, select chapter “03” of title “02.”

Press \uparrow/\downarrow or the number buttons to select “02” under “T,” then press ENTER.

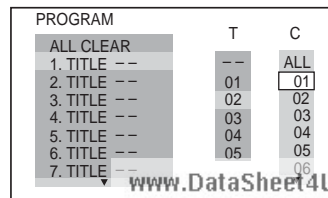

Next, press \uparrow/\downarrow or the number buttons to select "03" under "C," then press ENTER.

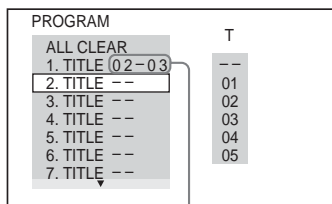

Selected title and chapter

◆ **When playing a VIDEO CD or CD**

For example, select track "02."

Press \uparrow/\downarrow or the number buttons to select "02" under "T," then press ENTER.

Selected track

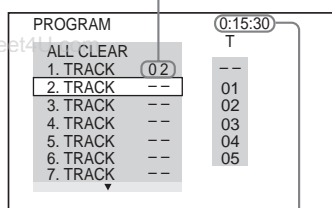

Total time of the programmed tracks

6 To programme other titles, chapters, or tracks, repeat steps 4 to 5.

The programmed titles, chapters, and tracks are displayed in the selected order.

7 Press \triangleright to start Programme Play.

Programme Play begins.

When the programme ends, you can restart the same programme again by pressing \triangleright .

To return to normal play

Press CLEAR, or select "OFF" in step 3. To play the same programme again, select "ON" in step 3 and press ENTER.

To turn off the display

Press DISPLAY repeatedly until the display is turned off.

To change or cancel a programme

1 Follow steps 1 through 3 of "Creating your own programme (Programme Play)."

2 Select the programme number of the title, chapter, or track you want to change or cancel using \uparrow/\downarrow or the number buttons, and press \rightarrow .

3 Follow step 5 for new programming. To cancel a programme, select "--" under "T," then press ENTER.

To cancel all the titles, chapters, or tracks in the programmed order

1 Follow steps 1 through 3 of "Creating your own programme (Programme Play)."

2 Press \uparrow and select "ALL CLEAR."

3 Press ENTER.

Hint

You can do Repeat Play or Shuffle Play of the programmed titles, chapters, or tracks. During Programme Play, follow the steps of "Repeat Play" (page 37) or "Shuffle Play" (page 36).

Notes

- When playing Super VCDs, the total time of the programmed tracks does not appear on the screen.
- You cannot use this function with VIDEO CDs with PBC playback.

Playing in random order (Shuffle Play) DVD-V VCD CD

You can have the player "shuffle" titles, chapters, or tracks. Subsequent "shuffling" may produce a different playing order.

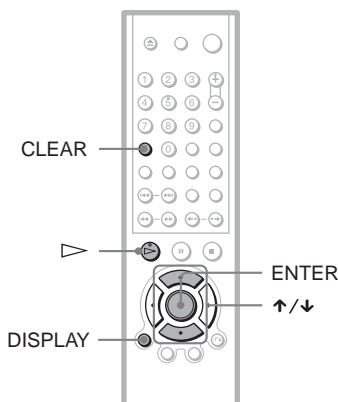

1 Press **DISPLAY** twice during playback (when playing a CD, press once).

The Control Menu appears.

2 Press **↑/↓** to select  (SHUFFLE), then press **ENTER**.

The options for “SHUFFLE” appear.

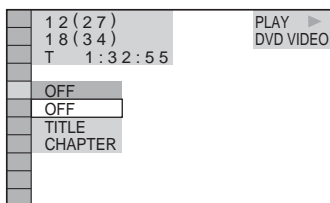

3 Press **↑/↓** to select the item to be shuffled.

◆ When playing a DVD VIDEO

- TITLE
- CHAPTER

◆ When playing a VIDEO CD or CD

- TRACK

◆ When Programme Play is activated

- ON: shuffles titles, chapters, or tracks selected in Programme Play.

4 Press **ENTER**.

Shuffle Play starts.

To return to normal play

Press **CLEAR**, or select “OFF” in Step 3.

To turn off the Control Menu

Press **DISPLAY** repeatedly until the Control Menu is turned off.

Hints

- You can set Shuffle Play while the player is stopped. After selecting the “SHUFFLE” option, press **▷**. Shuffle Play starts.
- Up to 200 chapters in a disc can be played in random order when “CHAPTER” is selected.

Note

You cannot use this function with VIDEO CDs with PBC playback.

Playing repeatedly (Repeat Play)

DVD-V DVD-RW VCD CD DATA CD

You can play all of the titles or tracks on a disc or a single title, chapter, or track repeatedly.

You can use a combination of Shuffle or Programme Play modes.

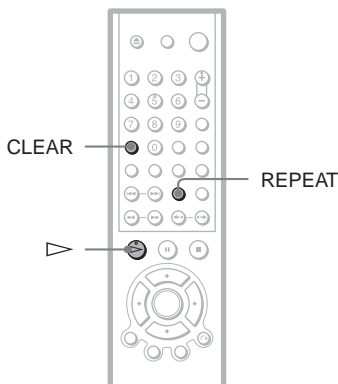

1 Press **REPEAT** during playback.

The following display appears.

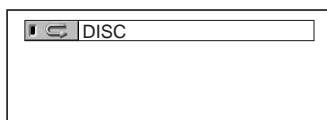

2 Press **REPEAT** repeatedly to select the item to be repeated.

◆ When playing a DVD VIDEO

- DISC: repeats all of the titles.
- TITLE: repeats the current title on a disc.
- CHAPTER: repeats the current chapter.

◆ When playing a DVD-RW

- DISC: repeats all the titles of the selected type.
- TITLE: repeats the current title on a disc.
- CHAPTER: repeats the current chapter.

- ◆ **When playing a VIDEO CD or CD**
 - DISC: repeats all of the tracks.
 - TRACK: repeats the current track.
- ◆ **When playing a DATA CD (MP3 audio)**
 - DISC: repeats all of the albums.
 - ALBUM: repeats the current album.
 - TRACK: repeats the current track.
- ◆ **When Programme Play or Shuffle Play is activated**
 - ON: repeats Programme Play or Shuffle Play.

To return to normal play

Press CLEAR, or select "OFF" in step 2.

Hints

- You can set Repeat Play while the player is stopped. After selecting the "REPEAT" option, press \triangleright . Repeat Play starts.
- You can also select "REPEAT" from the Control Menu (page 12).

Note

You cannot use this function with VIDEO CDs with PBC playback.

Repeating a specific portion (A-B Repeat Play) **DVD-V** **DVD-RW** **VCD**

CD

You can play a specific portion of a title, chapter or track repeatedly. (This function is useful when you want to memorize lyrics, etc.)

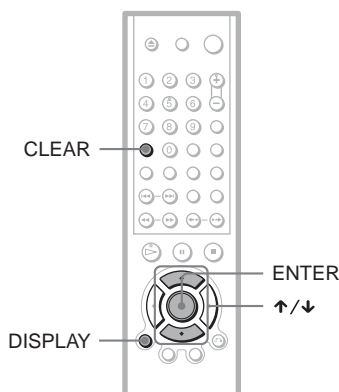

- 1 Press DISPLAY twice during playback (when playing a CD, press once). The Control Menu appears.
- 2 Press \uparrow/\downarrow to select **A-B** (A-B REPEAT), then press ENTER. The options for "A-B REPEAT" appear.

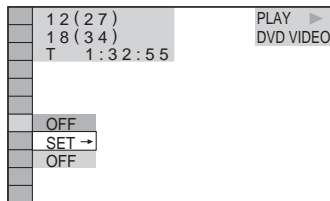

- 3 Press \uparrow/\downarrow to select "SET →," then press ENTER. The "A-B REPEAT" setting display appears.

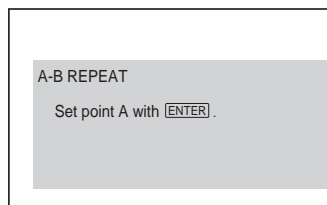

- 4 During playback, when you find the starting point (point A) of the portion to be played repeatedly, press ENTER. The starting point (point A) is set.

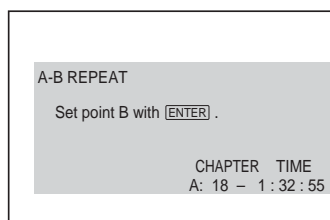

5 When you reach the ending point (point B), press ENTER again.

The set points are displayed and the player starts repeating this specific portion.

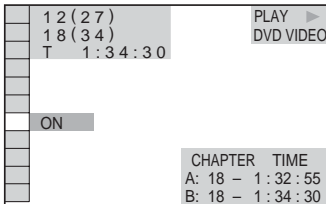

To return to normal play

Press CLEAR, or select "OFF" in step 3.

To turn off the Control Menu

Press DISPLAY repeatedly until the Control Menu is turned off.

Notes

- When you set A-B Repeat Play, the settings for Shuffle Play, Repeat Play, and Programme Play are cancelled.
- A-B Repeat Play does not work for titles containing still pictures on a DVD-RW in VR mode.
- A-B Repeat Play does not work across multiple titles on a DVD-RW in VR mode.

Searching for a Scene

Searching for a Particular Point on a Disc (Scan, Slow-motion Play, Search, Freeze Frame)

You can quickly locate a particular point on a disc by monitoring the picture or playing back slowly.

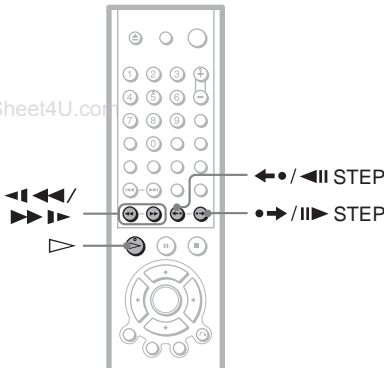

Playback Dial (DVP-NS530 only)



◀◀/▶▶ (DVP-NS730P only)

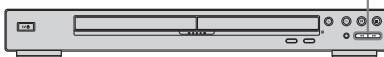

Note

Depending on the DVD/VIDEO CD, you may not be able to do some of the operations described.

Locating a point quickly by playing a disc in fast forward or fast reverse (Scan) **DVD-V** **DVD-RW**

VCD **CD** **DATA CD**

Press ◀◀◀◀ or ▶▶▶▶ while playing a disc. When you find the point you want, press ▷ to return to normal speed. Each time you press ◀◀◀◀ or ▶▶▶▶ during scan, the playback speed changes. With each press the indication changes as shown below. Actual speeds may differ with some discs.

Playback direction

×2▶▶ → FF1▶▶ → FF2▶▶ → FF3▶▶



FF3▶▶ (DVD VIDEO/DVD-RW/
VIDEO CD only)

×2▶▶ (DVD VIDEO/CD only)

Opposite direction

×2◀◀ → FR1◀◀ → FR2◀◀ → FR3◀◀



FR3◀◀ (DVD VIDEO/DVD-RW/
VIDEO CD only)

×2◀◀ (DVD VIDEO only)

The “×2▶▶”/“×2◀◀” playback speed is about twice the normal speed. The “FF3▶▶”/“FR3◀◀” playback speed is faster than “FF2▶▶”/“FR2◀◀” and the “FF2▶▶”/“FR2◀◀” playback speed is faster than “FF1▶▶”/“FR1◀◀.”

Watching frame by frame (Slow-motion Play) **DVD-V** **DVD-RW** **VCD**

Press ◀◀◀◀ or ▶▶▶▶ when the player is in pause mode. To return to the normal speed, press ▷.

Each time you press ◀◀◀◀ or ▶▶▶▶ during Slow-motion play, the playback speed changes. Two speeds are available. With each press the indication changes as follows:

Playback direction

SLOW2▶▶ ↔ SLOW1▶▶

Opposite direction (DVD only)

SLOW2◀◀ ↔ SLOW1◀◀

The “SLOW2▶▶”/“SLOW2◀◀” playback speed is slower than “SLOW1▶▶”/“SLOW1◀◀.”

Using the Playback Dial on the player (DVP-NS530 only) **DVD-V**

DVD-RW VCD CD DATA CD

You can search for a particular point on a disc in various ways using the Playback Dial.

To go to the next chapter/track/scene

During playback, briefly turn the Playback Dial clockwise to skip to the next chapter/track/scene, or counterclockwise to skip to the previous ones.

To locate a point quickly (Search)

During playback, turn and hold the Playback Dial clockwise to locate a point in the playback direction, or counterclockwise to locate a point in the opposite direction. When you find the point you want, release the dial to return to normal playback speed.

To locate a point quickly using the PREV (previous)/NEXT (next) buttons (Search) (DVP-NS730P only) **DVD-V DVD-RW VCD CD DATA CD**

You can search for a particular point on a disc using **◀◀/▶▶** on the player.

During playback, press and hold **▶▶** on the player to locate a point in the playback direction, or press and hold **◀◀** to locate a point in the opposite direction. When you find the point you want, release the button to return to normal playback speed.

Playing one frame at a time (Freeze Frame) **DVD-V DVD-RW VCD**

When the player is in the pause mode, press **•→/||▶** STEP to go to the next frame. Press **◀•/◀||** STEP to go to the preceding frame (DVD only). If you hold the button down, you can view the frames in succession. To return to normal playback, press **▷**.

Searching for a Title/Chapter/Track/Scene, etc. **DVD-V DVD-RW VCD CD**

DATA CD

You can search a DVD by title or chapter, and you can search a VIDEO CD/CD/DATA CD by track, index, or scene. As titles and tracks are assigned unique numbers on the disc, you can select the desired one by entering its number. Or, you can search for a scene using the time code.

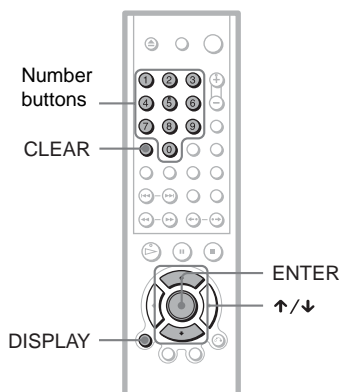



1 Press DISPLAY.

The Control Menu appears.

2 Press **↑/↓** to select the search method.

◆ When playing a DVD VIDEO/DVD-RW

-  TITLE
-  CHAPTER
-  TIME/TEXT

Select "TIME/TEXT" to search for a starting point by inputting the time code.

◆ When playing a VIDEO CD without PBC playback

-  TRACK
-  INDEX

www.DataSheet4U.com

◆ When playing a VIDEO CD with PBC Playback

 SCENE

 INDEX

◆ When playing a CD

 TRACK

 INDEX

◆ When playing a DATA CD (MP3 audio)

 ALBUM

 TRACK

Example: when you select  CHAPTER

“** (**)” is selected (** refers to a number).

The number in parentheses indicates the total number of titles, chapters, tracks, indexes or scenes.

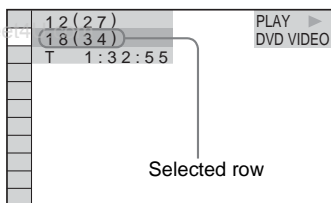

3 Press ENTER.

“** (**)” changes to “-- (**).”

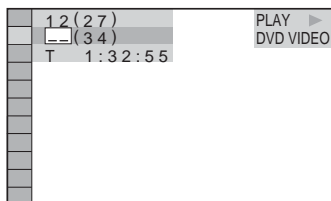

4 Press \uparrow/\downarrow or the number buttons to select the title, chapter, track, index, or scene number you want to search.

If you make a mistake

Cancel the number by pressing CLEAR, then select another number.

5 Press ENTER.

The player starts playback from the selected number.

To turn off the Control Menu

Press DISPLAY repeatedly until the Control Menu is turned off.

To search for a scene using the time code (DVD VIDEO/DVD-RW only)

- 1 In step 2, select  TIME/TEXT. “T **: **: : **” (playing time of the current title) is selected.
- 2 Press ENTER. “T **: **: : **” changes to “T --: --: --.”
- 3 Input the time code using the number buttons, then press ENTER. For example, to find the scene at 2 hours, 10 minutes, and 20 seconds after the beginning, just enter “2:10:20.”

 Hints

- When the Control Menu display is turned off, you can search for a chapter (DVD VIDEO/DVD-RW) or track (CD) by pressing the number buttons and ENTER.
- You can display the first scene of titles, chapters, or tracks recorded on the disc on a screen divided into 9 sections. You can start playback directly by selecting one of the scenes. For details, see “Searching by Scene (PICTURE NAVIGATION)” on the next page.

Notes

- The title, chapter, or track number displayed is the same number recorded on the disc.
- You cannot search for a still picture on a DVD-RW in VR mode.
- You cannot search for a scene on a DVD+RW using the time code.

Searching by Scene

(PICTURE NAVIGATION) **DVD-V** **VCD**

You can divide the screen into 9 subscreens and find the desired scene quickly.

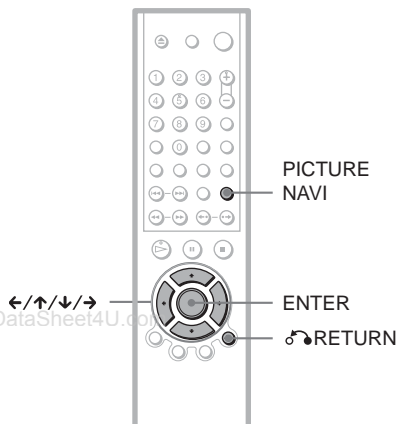

1 Press PICTURE NAVI during playback.

The following display appears.

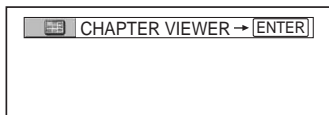

2 Press PICTURE NAVI repeatedly to select the item.

Refer to the explanations given for each item in the following sections.

- CHAPTER VIEWER (for DVD VIDEO only)
- TITLE VIEWER (for DVD VIDEO only)
- TRACK VIEWER (for VIDEO CD only)

3 Press ENTER.

To return to normal play

Press RETURN.

Hint

You can also select "PICTURE NAVIGATION" from the Control Menu (page 12).

Notes

- The "PICTURE NAVIGATION" is not available when playing Super VCDs.
- Depending on the disc, you may not be able to select all functions.
- The sound is muted when using this function.

Scanning the title, chapter, or track (TITLE VIEWER, CHAPTER VIEWER, TRACK VIEWER)

DVD-V **VCD**

You can divide the screen into 9 subscreens and display the first scene of titles, chapters, or tracks.

You can also play back from the selected title, chapter, or track. After performing step 3 of "Searching by Scene (PICTURE NAVIGATION)" above, select the scene using and press ENTER.

Hint

If there are more than 9 titles, chapters, or tracks, ▼ is displayed at the bottom right.

To display the additional titles, chapters, or tracks, select the bottom right scene (the position 9) and press . To return to the previous scene, select the top left scene (the position 1) and press .

1	2	3
4	5	6
7	8	9

▼

Viewing Information About the Disc

Checking the Playing Time and Remaining Time

DVD-V DVD-RW VCD CD
DATA CD

You can check the playing time and remaining time of the current title, chapter, or track. Also, you can check the DVD/CD text or track name (MP3 audio) recorded on the disc.

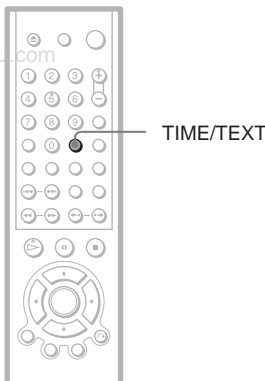

1 Press TIME/TEXT during playback.

The following display appears.

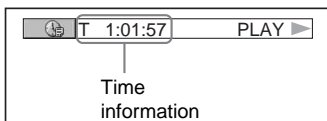

2 Press TIME/TEXT repeatedly to change the time information.

The display and the kinds of time that you can change depend on the disc you are playing.

◆ When playing a DVD VIDEO or DVD-RW

- T *:*:~* (hours: minutes: seconds)
Playing time of the current title
- T- *:*:~*
Remaining time of the current title
- C *:*:~*
Playing time of the current chapter
- C- *:*:~*
Remaining time of the current chapter

◆ When playing a VIDEO CD (with PBC functions)

- *:*:~* (minutes: seconds)
Playing time of the current scene

◆ When playing a VIDEO CD (without PBC functions) or CD

- T *:*:~* (minutes: seconds)
Playing time of the current track
- T- *:*:~*
Remaining time of the current track
- D *:*:~*
Playing time of the current disc
- D- *:*:~*
Remaining time of the current disc

◆ When playing a DATA CD (MP3 audio)

- *:*:~* (minutes: seconds)
Playing time of the current track

◆ When playing a Super VCD

- T *:*:~* (minutes: seconds)
Playing time of the current track

To check the DVD/CD text or track and album names (MP3 audio)

Press TIME/TEXT repeatedly in step 2 to display text recorded on the DVD VIDEO/CD/DATA CD.

The DVD/CD text appears only when text is recorded in the disc. You cannot change the text. If the disc does not contain text, "NO TEXT" appears.



For DATA CDs, the track and album names of the MP3 audio track appears (page 47).

Checking the information on the front panel display

You can view the time information and text displayed on the TV screen also on the front panel display. The information on the front panel display changes as follows when you change the time information on your TV screen.

When playing a DVD VIDEO or DVD-RW

Playing time of the current title

T 103:24



Remaining time of the current title

T- 1:15:36



Playing time of the current chapter

C 0:22:30



Remaining time of the current chapter

C-0 13:20



Text

SONY HI



Current title and chapter number

T 16 8

(returns to top automatically)

When playing a DATA CD (MP3 audio)

Playing time and number of the current track

6 2:25



Track name

01HAPPY

When playing a VIDEO CD (without PBC functions) or CD

Playing time and number of the current track

3 2:25



Remaining time of the current track

3 - 1:50



Playing time of the disc

32:12



Remaining time of the disc

-20:18



Text

SONY HI



Current track and index number

3 1

(returns to top automatically)

Hints

- When playing VIDEO CDs with PBC functions, the scene number or the playing time are displayed.
- Long text that does not fit in a single line will scroll across the front panel display.
- You can also check the time information and text using the Control Menu (page 12).

Notes

- Depending on the type of disc being played, the DVD/CD text or track name may not be displayed.
- The player can only display the first level of the DVD/CD text, such as the disc name or title.
- Playing time of MP3 audio tracks may not be displayed correctly.

Checking the Play Information

You can check information such as the bit rate or the disc layer that is being played.

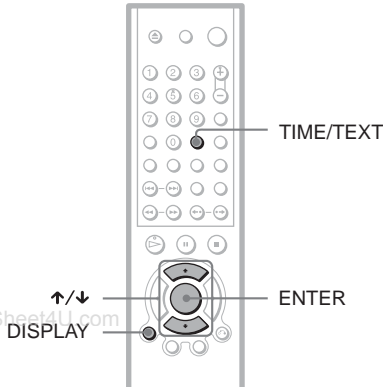

To turn off the Control Menu

Press DISPLAY repeatedly until the Control Menu is turned off.

Display of each item

By pressing DISPLAY repeatedly, you can display either "BIT RATE" or "LAYER," whichever was selected in "ADVANCED."

◆BIT RATE

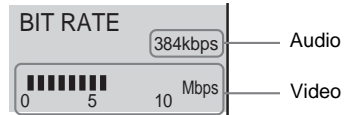

When playing MPEG audio sound tracks

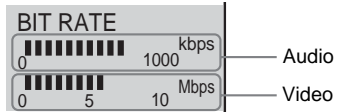

Bit rate refers to the amount of video/audio data per second in a disc. While playing a disc, an approximate bit rate of the playback picture is displayed as Mbps (Mega bit per second) and the audio as kbps (kilo bit per second). The higher the bit rate, the larger the amount of data. However, this does not always mean that you can get higher quality pictures or sounds.

◆LAYER

Appears when the DVD has dual layers



Indicates the approximate point where the disc is playing.

If it is a dual-layer DVD, the player indicates which layer is being read ("Layer 0" or "Layer 1").

For details on the layers, see page 71 (DVD VIDEO).

Checking the play information of a DVD (ADVANCED) DVD-V DVD-RW

- 1 Press DISPLAY during playback. The Control Menu is displayed.
- 2 Press \uparrow/\downarrow to select **BIT RATE** (ADVANCED), then press ENTER. The options for "ADVANCED" appear.

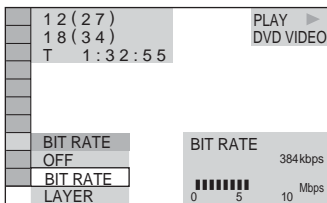

- 3 Press \uparrow/\downarrow to select items. For each item, please refer to "Displays of each item."
 - BIT RATE: displays the bit rate.
 - LAYER: displays the layer and the pick-up point.
- 4 Press ENTER.

To turn off the ADVANCED window

Select "OFF" in step 3.

Checking the play information of a DATA CD

By pressing TIME/TEXT while playing MP3 audio tracks on a DATA CD, you can display the audio bit rate (the amount of data per second of the current audio).

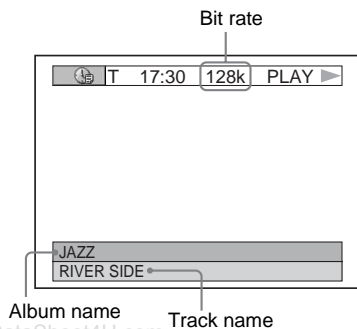

www.DataSheet4U.com

Sound Adjustments

Changing the Sound DVD-V

DVD-RW VCD CD DATA CD

When playing a DVD VIDEO recorded in multiple audio formats (PCM, Dolby Digital, MPEG audio, or DTS), you can change the audio format. If the DVD VIDEO is recorded with multilingual tracks, you can also change the language.

With CDs, DATA CDs, or VIDEO CDs, you can select the sound from the right or left channel and listen to the sound of the selected channel through both the right and left speakers. For example, when playing a disc containing a song with the vocals on the right channel and the instruments on the left channel, you can hear the instruments from both speakers by selecting the left channel.

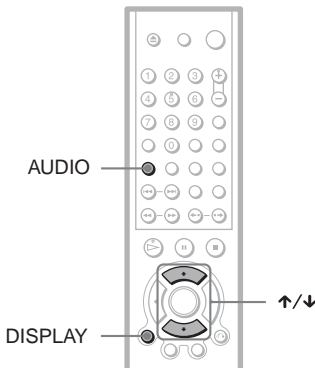

1 Press AUDIO during playback.

The following display appears.

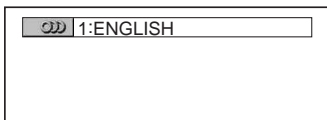

2 Press AUDIO repeatedly to select the desired audio signal.

◆ When playing a DVD VIDEO

Depending on the DVD VIDEO, the choice of language varies.

When 4 digits are displayed, they indicate a language code. Refer to "Language Code List" on page 74 to see which language the code represents. When the same language is displayed two or more times, the DVD VIDEO is recorded in multiple audio formats.

◆ When playing a DVD-RW

The types of sound tracks recorded on a disc are displayed. The default setting is underlined.

Example:

- 1: MAIN (main sound)
- 1: SUB (sub sound)
- 1: MAIN+SUB (main and sub sound)

◆ When playing a VIDEO CD, CD, or DATA CD (MP3 audio)

The default setting is underlined.

- STEREO: The standard stereo sound
- 1/L: The sound of the left channel (monaural)
- 2/R: The sound of the right channel (monaural)

◆ When playing a Super VCD

The default setting is underlined.

- 1:STEREO: The stereo sound of the audio track 1
- 1:1/L: The sound of the left channel of the audio track 1 (monaural)
- 1:2/R: The sound of the right channel of the audio track 1 (monaural)
- 2:STEREO: The stereo sound of the audio track 2
- 2:1/L: The sound of the left channel of the audio track 2 (monaural)
- 2:2/R: The sound of the right channel of the audio track 2 (monaural)

💡 Hint

You can also select "AUDIO" from the Control Menu (page 12).

Note

While playing a Super VCD on which the audio track 2 is not recorded, no sound will come out when you select "2:STEREO," "2:1/L," or "2:2/R."

Displaying the audio information of the disc **DVD-V**

Press DISPLAY during playback to display the Control Menu. Select "AUDIO" using \uparrow/\downarrow . The channels being played are displayed on the screen.

For example, in Dolby Digital format, multiple signals ranging from monaural to 5.1 channel signals can be recorded on a DVD VIDEO. Depending on the DVD VIDEO, the number of the recorded channels may differ.

Current audio format*

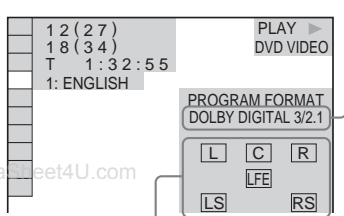

Currently playing programme format**

*"PCM," "MPEG," "DTS," or "DOLBY DIGITAL" is displayed.

In the case of "DOLBY DIGITAL," the channels in the playing track are displayed by numbers as follows:

For Dolby Digital 5.1 ch:

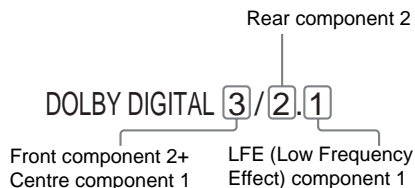

**The letters in the programme format display indicate the following sound components:

- L: Front (left)
- R: Front (right)
- C: Centre
- LS: Rear (left)
- RS: Rear (right)
- S: Rear (monaural): The rear component of the Dolby Surround processed signal and the Dolby Digital signal
- LFE: Low Frequency Effect signal

Hint

For Dolby Digital and DTS, "LFE" is always enclosed in a solid line regardless of the LFE signal component being output.

Note

If "DTS" is set to "OFF" in "AUDIO SETUP," the DTS track selection option will not appear on the screen even if the disc contains DTS tracks (page 67).

TV Virtual Surround Settings (TVS) **DVD-V**

When you connect a stereo TV or 2 front speakers, TVS (TV Virtual Surround) lets you enjoy surround sound effects by using sound imaging to create virtual rear speakers from the sound of the front speakers (L: left, R: right) without using actual rear speakers. TVS was developed by Sony to produce surround sound for home use using just a stereo TV.

If the player is set up to output the signal from the DIGITAL OUT (OPTICAL or COAXIAL) jack, the surround effect will only be heard when "DOLBY DIGITAL" is set to "D-PCM" and "MPEG" is set to "PCM" in "AUDIO SETUP" (page 67).

www.DataSheet4U.com

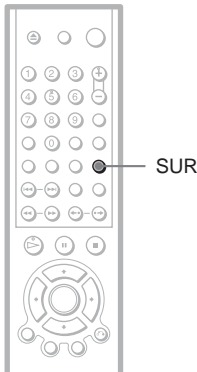

1 Press SUR during playback.

The following display appears.

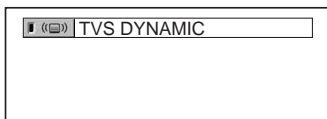

2 Press SUR repeatedly to select one of the TVS sounds.

Refer to the following explanations given for each item.

- TVS DYNAMIC
- TVS WIDE
- TVS NIGHT
- TVS STANDARD

To cancel the setting

Select "OFF" in step 2.

◆TVS DYNAMIC

Creates virtual rear speakers from the sound of the front speakers (L, R) without using actual rear speakers (shown below).

This mode is effective when the distance between the front L and R speakers is short, such as with built-in speakers on a stereo TV.



◆TVS WIDE

Creates virtual rear speakers from the sound of the front speakers (L, R) without using actual rear speakers. The virtual speakers are reproduced as shown in the illustration below.

This mode is effective when the distance between the front L and R speakers is short, such as with built-in speakers on a stereo TV.

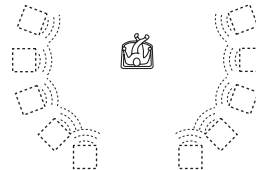

◆TVS NIGHT

Large sounds, such as explosions, are suppressed, but the quieter sounds are unaffected. This feature is useful when you want to hear the dialog and enjoy the surround sound effects of "TVS WIDE" at low volume.

◆TVS STANDARD

Creates virtual rear speakers from the sound of the front speakers (L, R) without using actual rear speakers. The virtual speakers are reproduced as shown in the illustration below. Use this setting when you want to use TVS with 2 separate speakers.

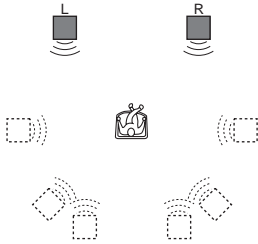

L: Front speaker (left)
 R: Front speaker (right)
 □: Virtual speaker

💡 Hints

- You can select “TVS” by pressing the SURROUND button on the player.
- You can also select “TVS” from the Control Menu (page 12).

📝 Notes

- When the playing signal does not contain a signal for the rear speakers, the surround effects will be difficult to hear.
- When you select one of the TVS modes, turn off the surround setting of the connected TV or amplifier (receiver).
- Make sure that your listening position is between and at an equal distance from your speakers, and that the speakers are located in similar surroundings.
- Not all discs will respond to the “TVS NIGHT” function in the same way.
- When you use the DIGITAL OUT (COAXIAL or OPTICAL) jack to listen to MPEG audio signals and set “MPEG” to MPEG in “AUDIO SETUP”, no sound will come from your speakers if you select one of the TVS modes.

Changing the Angles

DVD-V

If various angles (multi-angles) for a scene are recorded on the DVD VIDEO, “” appears in the front panel display. This means that you can change the viewing angle.

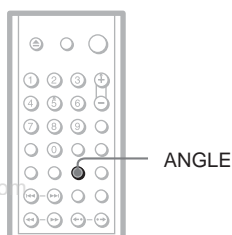

1 Press ANGLE during playback.

The number of the angle appears on the display.

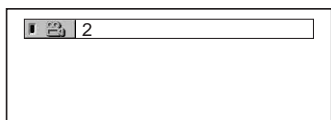

2 Press ANGLE repeatedly to select the angle number.

The scene changes to the selected angle.

Hint

You can also select “ANGLE” from the Control Menu (page 12).

Note

Depending on the DVD VIDEO, you may not be able to change the angles even if multi-angles are recorded on the DVD VIDEO.

Displaying the Subtitles

DVD-V DVD-RW

If subtitles are recorded on the discs, you can change the subtitles or turn them on and off whenever you want while playing a DVD.

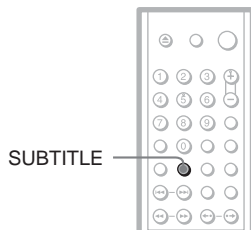

1 Press SUBTITLE during playback.

The following display appears.

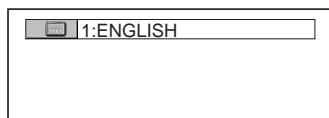

2 Press SUBTITLE repeatedly to select the setting.

◆ When playing a DVD VIDEO

Select the language.

Depending on the DVD VIDEO, the choice of language varies.

When 4 digits are displayed, they indicate a language code. Refer to “Language Code List” on page 74 to see which language the code represents.

◆ When playing a DVD-RW

Select “ON.”

To turn off the subtitles

Select “OFF” in step 2.

Hint

You can also select “SUBTITLE” from the Control Menu (page 12).

Note

Depending on the DVD VIDEO, you may not be able to change the subtitles even if multilingual subtitles are recorded on it. You also may not be able to turn them off.

Adjusting the Picture Quality (BNR) **DVD-V** **DVD-RW**

VCD

The Block Noise Reduction (BNR) function adjusts the picture quality by reducing the “block noise” or mosaic like patterns that appear on your TV screen.

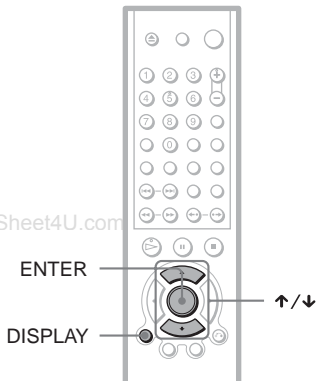

1 Press DISPLAY twice during playback.

The Control Menu appears.

2 Press ↑/↓ to select **BNR** (BNR), then press ENTER.

The options for “BNR” appear.

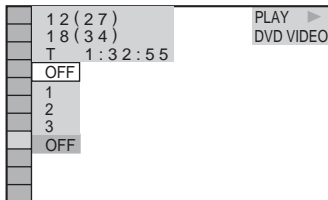

3 Press ↑/↓ to select a level.

- 1: reduces the “block noise.”
- 2: reduces the “block noise” more than 1.
- 3: reduces the “block noise” more than 2.

4 Press ENTER.

The disc plays with the setting you selected.

To cancel the “BNR” setting

Select “OFF” in step 3.

To turn off the Control Menu

Press DISPLAY repeatedly until the Control Menu is turned off.

Notes

- If the outlines of the images on your screen should become blurred, set “BNR” to “OFF.”
- Depending on the disc or the scene being played, there may be no “BNR” effect, or it may be hard to discern.

Adjusting the Playback Picture (CUSTOM PICTURE MODE)

DVD-V DVD-RW VCD

You can adjust the video signal of the DVD or VIDEO CD from the player to obtain the picture quality you want. Choose the setting that best suits the programme you are watching.

When you select "MEMORY," you can make further adjustments to each element of the picture (colour, brightness, etc.). (DVP-NS730P only)

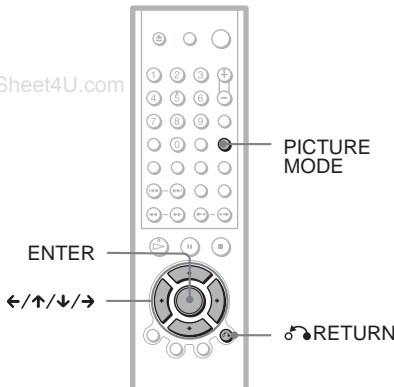

1 Press PICTURE MODE during playback.

The following display appears.

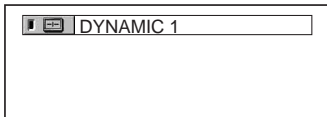

2 Press PICTURE MODE repeatedly to select the setting you want.

The default setting is underlined.

- STANDARD: displays a standard picture.
- DYNAMIC 1: produces a bold dynamic picture by increasing the picture contrast and the colour intensity.
- DYNAMIC 2: produces a more dynamic picture than DYNAMIC 1 by

further increasing the picture contrast and the colour intensity.

- **CINEMA 1**: enhances details in dark areas by increasing the black level.
- **CINEMA 2**: White colours become brighter and black colours become richer, and the colour contrast is increased.
- **MEMORY**: adjusts the picture in greater detail. (DVP-NS730P only)

Hints

- When you watch a movie, "CINEMA 1" or "CINEMA 2" is recommended.
- The picture can be adjusted by pressing the PICTURE MODE button on the player as well.
- You can also select "CUSTOM PICTURE MODE" from the Control Menu (page 12).

Adjusting the picture items in "MEMORY" (DVP-NS730P only)

You can adjust each element of the picture individually.

- **PICTURE**: changes the contrast
- **BRIGHTNESS**: changes the overall brightness
- **COLOR**: makes the colours deeper or lighter
- **HUE**: changes the colour balance

1 Press PICTURE MODE repeatedly to select "MEMORY" then press ENTER. The "PICTURE" adjustment bar appears.



2 Press </> to adjust the picture contrast, then press ENTER.

The adjustment is saved, and "BRIGHTNESS" adjustment bar appears.

3 Repeat step 2 to adjust "BRIGHTNESS," "COLOR," and "HUE."

The Custom Picture Mode display appears.

www.DataSheet4U.com

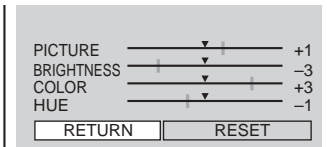

To turn off the display

Press **↵** RETURN, or select "RETURN" in step 3 and press ENTER.

Hints

- To reset the picture items to the default values, press **→** after step 3 to select "RESET" and press ENTER.
- If you do not want to save the adjustment in step 2, you can go to the next picture adjustment item by pressing **↑/↓** without saving.

www.DataSheet4U.com

Enhancing the Playback Picture (DIGITAL VIDEO

ENHANCER) **DVD-V** **DVD-RW** **VCD**

The Digital Video Enhancer (DVE) function makes the picture appear clear and crisp by enhancing the outlines of images on your TV screen. Also, this function can soften the images on the screen.

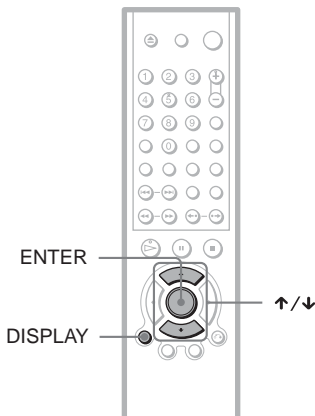

Enjoying Movies

1 Press DISPLAY twice during playback.

The Control Menu appears.

2 Press **↑/↓** to select (DIGITAL VIDEO ENHANCER), then press ENTER.

The options for "DIGITAL VIDEO ENHANCER" appear.

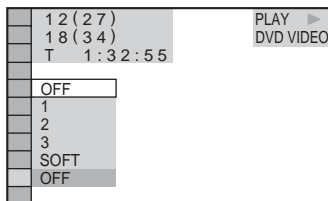

www.DataSheet4U.com

3 Press \uparrow/\downarrow to select a level.

- 1: enhances the outline.
- 2: enhances the outline more than 1.
- 3: enhances the outline more than 2.
- SOFT: softens the image (DVD only).

4 Press ENTER.

The disc plays with the setting you selected.

To cancel the "DIGITAL VIDEO ENHANCER" setting

Select "OFF" in step 3.

To turn off the Control Menu

Press DISPLAY repeatedly until the Control Menu is turned off.

Note

Depending on the disc or the scene being played, noise found in the disc may become more apparent. If this happens, it is recommended that you use the BNR function (page 53) with the DVE function. If the condition still does not improve, reduce the Digital Video Enhancer level, or select "SOFT" (DVD only) in step 3 above.

Using Various Additional Functions

Locking Discs (CUSTOM PARENTAL CONTROL, PARENTAL CONTROL)

You can set two kinds of playback restrictions for the desired disc.

- Custom Parental Control
You can set playback restrictions so that the player will not play inappropriate discs.
- Parental Control
Playback of some DVD VIDEOS can be limited according to a predetermined level such as the age of the users. Scenes may be blocked or replaced with different scenes. The same password is used for both Parental Control and Custom Parental Control.

Custom Parental Control DVD-V

VCD CD

You can set the same Custom Parental Control password for up to 40 discs. When you set the 41st-disc, the first disc is cancelled.

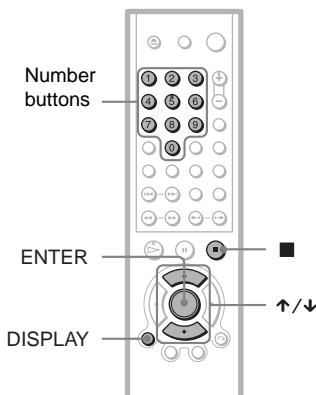

- 1 Insert the disc you want to lock.
If the disc is playing, press ■ to stop playback.
- 2 Press DISPLAY while the player is in stop mode.
The Control Menu appears.

- 3 Press ↑/↓ to select  (PARENTAL CONTROL), then press ENTER.

The options for "PARENTAL CONTROL" appear.

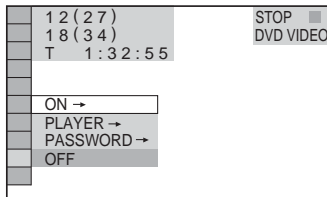

- 4 Press ↑/↓ to select "ON →," then press ENTER.

◆ If you have not entered a password
The display for registering a new password appears.

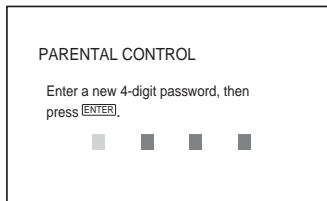

Enter a 4-digit password using the number buttons, then press ENTER.
The display for confirming the password appears.

◆ When you have already registered a password
The display for entering the password appears.

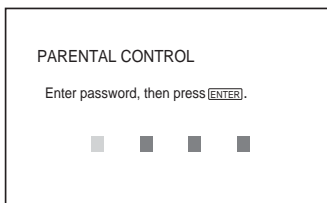

- 5 Enter or re-enter your 4-digit password using the number buttons, then press ENTER.

"Custom parental control is set." appears and then the screen returns to the Control Menu.

To turn off the Custom Parental Control function

- 1 Follow steps 1 through 3 of “Custom Parental Control.”
- 2 Press \uparrow/\downarrow to select “OFF \rightarrow ,” then press ENTER.
- 3 Enter your 4-digit password using the number buttons, then press ENTER.

To play a disc for which Custom Parental Control is set

- 1 Insert the disc for which Custom Parental Control is set. The “CUSTOM PARENTAL CONTROL” display appears.

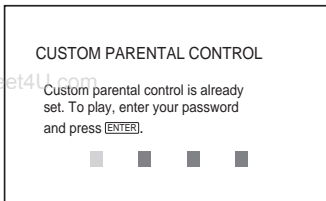

- 2 Enter your 4-digit password using the number buttons, then press ENTER. The player is ready for playback.

Hint

If you forget your password, enter the 6-digit number “199703” using the number buttons when the “CUSTOM PARENTAL CONTROL” display asks you for your password, then press ENTER. The display will ask you to enter a new 4-digit password.

Note

Once you set Custom Parental Control with a recorded disc such as a DVD-RW, the display for entering the password may appear again when you insert a different recorded disc. Input the password to play the disc.

Parental Control (limited playback) **DVD-V**

Playback of some DVD VIDEOS can be limited according to a predetermined level such as the age of the users. The “PARENTAL CONTROL” function allows you to set a playback limitation level.

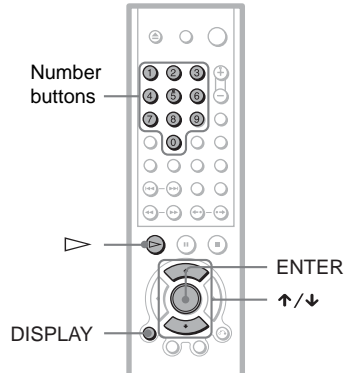

- 1 Press DISPLAY while the player is in stop mode. The Control Menu appears.
- 2 Press \uparrow/\downarrow to select (PARENTAL CONTROL), then press ENTER. The options for “PARENTAL CONTROL” appear.

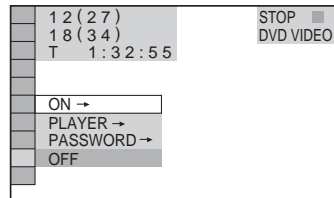

- 3 Press \uparrow/\downarrow to select “PLAYER \rightarrow ,” then press ENTER.

◆ If you have not entered a password The display for registering a new password appears.

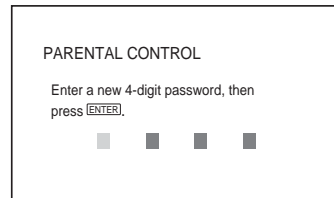

Enter a 4-digit password using the number buttons, then press ENTER. The display for confirming the password appears.

◆ When you have already registered a password

The display for entering the password appears.

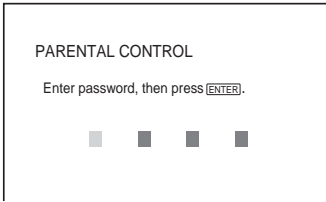

4 Enter or re-enter your 4-digit password using the number buttons, then press ENTER.

The display for setting the playback limitation level appears.

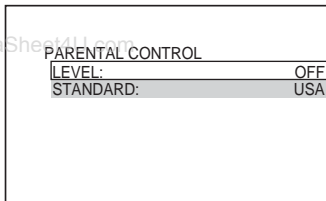

5 Press \uparrow/\downarrow to select "STANDARD," then press ENTER.

The selection items for "STANDARD" are displayed.

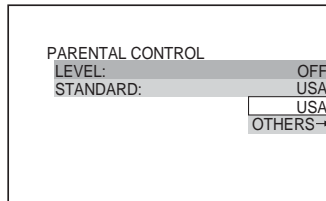

6 Press \uparrow/\downarrow to select a geographic area as the playback limitation level, then press ENTER.

The area is selected.

When you select "OTHERS →," select and enter a standard code in the table on page 60 using the number buttons.

7 Press \uparrow/\downarrow to select "LEVEL," then press ENTER.

The selection items for "LEVEL" are displayed.

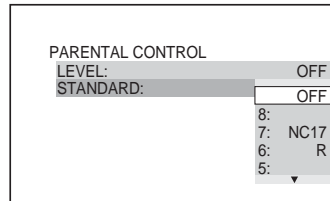

8 Select the level you want using \uparrow/\downarrow , then press ENTER.

Parental Control setting is complete.

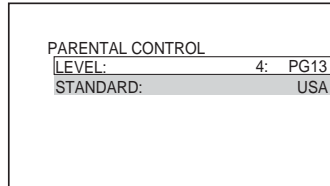

The lower the value, the stricter the limitation.

To turn off the Parental Control function
Set "LEVEL" to "OFF" in step 8.

To play a disc for which Parental Control is set

- 1 Insert the disc and press \triangleright .
The display for entering your password appears.
- 2 Enter your 4-digit password using the number buttons, then press ENTER.
The player starts playback.

Hint

If you forget your password, remove the disc and repeat steps 1 to 3 of "Parental Control (limited playback)." When you are asked to enter your password, enter "199703" using the number buttons, then press ENTER. The display will ask you to enter a new 4-digit password. After you enter a new 4-digit password, replace the disc in the player and press \triangleright . When the display for entering your password appears, enter your new password.

Notes

- When you play discs which do not have the Parental Control function, playback cannot be limited on this player.
- Depending on the disc, you may be asked to change the parental control level while playing the disc. In this case, enter your password, then change the level. If the password is cancelled, the level returns to the previous level.

Area Code

Standard	Code number
Argentina	2044
Australia	2047
Austria	2046
Belgium	2057
Brazil	2070
Canada	2079
Chile	2090
China	2092
Denmark	2115
Finland	2165
France	2174
Germany	2109
India	2248
Indonesia	2238
Italy	2254
Japan	2276
Korea	2304
Malaysia	2363
Mexico	2362
Netherlands	2376
New Zealand	2390
Norway	2379
Pakistan	2427
Philippines	2424
Portugal	2436
Russia	2489
Singapore	2501
Spain	2149
Sweden	2499
Switzerland	2086
Thailand	2528
United Kingdom	2184

Changing the password

- 1 Press **DISPLAY** while the player is in stop mode.
The Control Menu appears.
- 2 Press **↑/↓** to select  (PARENTAL CONTROL), then press **ENTER**.
The options for "PARENTAL CONTROL" appear.
- 3 Press **↑/↓** to select "PASSWORD →," then press **ENTER**.
The display for entering the password appears.
- 4 Enter your 4-digit password using the number buttons, then press **ENTER**.
- 5 Enter a new 4-digit password using the number buttons, then press **ENTER**.
- 6 To confirm your password, re-enter it using the number buttons, then press **ENTER**.

If you make a mistake entering your password

Press **←** before you press **ENTER** and input the correct number.

If you make a mistake

Press **↶** RETURN.

To turn off the display

Press **DISPLAY** repeatedly until the display is turned off.

Controlling Your TV with the Supplied Remote

You can control the sound level, input source, and power switch of your Sony TV with the supplied remote.

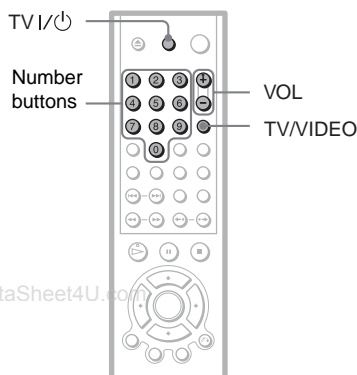

You can control your TV using the buttons below.

By pressing	You can
TV I/O	Turn the TV on or off
VOL +/-	Adjust the volume of the TV
TV/VIDEO	Switch the TV's input source between the TV and other input sources.

Note

Depending on the unit being connected, you may not be able to control your TV using all or some of the buttons on the supplied remote.

Controlling other TVs with the remote

You can control the sound level, input source, and power switch of non-Sony TVs as well. If your TV is listed in the table below, set the appropriate manufacturer's code.

1 While holding down TV I/O, press the number buttons to select your TV's manufacturer's code (see the table below).

2 Release TV I/O.

Code numbers of controllable TVs

If more than one code number is listed, try entering them one at a time until you find the one that works with your TV.

Manufacturer	Code number
Sony (default)	01
Aiwa (default)	01
Grundig	11
Hitachi	24
JVC	33
LG	06
Panasonic	17, 49
Philips	06, 08
Samsung	06
Sanyo	25
Sharp	29
Thomson	43
Toshiba	38

Notes

- If you enter a new code number, the code number previously entered will be erased.
- When you replace the batteries of the remote, the code number you have set may be reset to the default setting. Set the appropriate code number again.
- Depending on the unit being connected, you may not be able to control your TV using all or some of the buttons on the supplied remote.

Settings and Adjustments

Using the Setup Display

By using the Setup Display, you can make various adjustments to items such as picture and sound. You can also set a language for the subtitles and the Setup Display, among other things. For details on each Setup Display item, see pages from 63 to 67.

The on-screen displays and available options differ depending on the player model. Note the differences indicated in the text, for example, "DVP-NS530 only."

Note

Playback settings stored in the disc take priority over the Setup Display settings and not all the functions described may work.

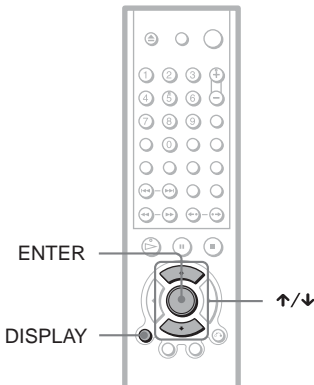

- 1 Press **DISPLAY** when the player is in stop mode.

The Control Menu appears.

- 2 Press **↑/↓** to select  (SETUP), then press **ENTER**.

The options for "SETUP" appear.

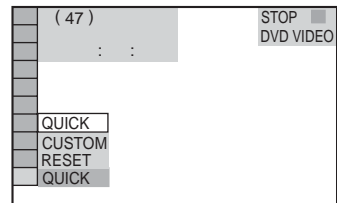

- 3 Press **↑/↓** to select "CUSTOM," then press **ENTER**.

The Setup Display appears.

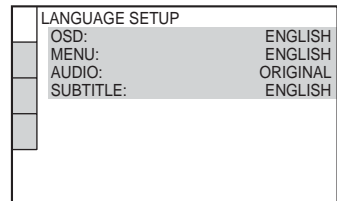

- 4 Press **↑/↓** to select the setup item from the displayed list: "LANGUAGE SETUP," "SCREEN SETUP," "CUSTOM SETUP," or "AUDIO SETUP." Then press **ENTER**.

The Setup item is selected.

Example: "SCREEN SETUP"

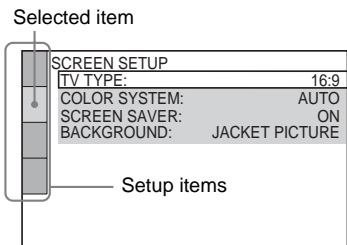

- 5 Select an item using **↑/↓**, then press **ENTER**.

The options for the selected item appear.
Example: "TV TYPE"

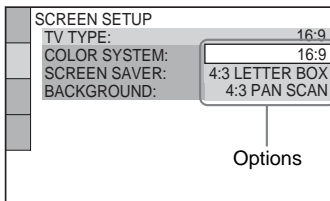

6 Select a setting using \uparrow/\downarrow , then press ENTER.

The setting is selected and setup is complete.

Example: "4:3 PAN SCAN"

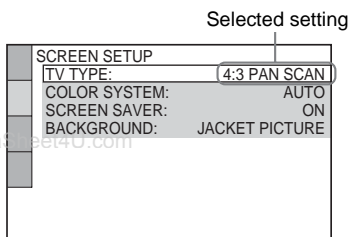

To turn off the display

Press DISPLAY repeatedly until the display is turned off.

To enter the Quick Setup mode

Select "QUICK" in step 3. Follow from step 5 of the Quick Setup explanation to make basic adjustment (page 24).

To reset all the "SETUP" settings

- 1 Select "RESET" in step 3 and press ENTER.
- 2 Select "YES" using \uparrow/\downarrow .
You can also quit the process and return to the Control Menu by selecting "NO" here.
- 3 Press ENTER.

All the settings explained on pages 63 to 67 return to the default settings. Do not press \mathbb{I}/\mathbb{C} while resetting the player, which takes a few seconds to complete.

Setting the Display or Sound Track Language

(LANGUAGE SETUP)

"LANGUAGE SETUP" allows you to set various languages for the on-screen display or sound track.

Select "LANGUAGE SETUP" in the Setup Display. To use the display, see "Using the Setup Display" (page 62).

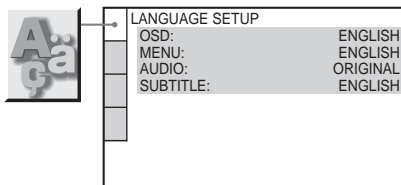

◆ OSD (On-Screen Display)

Switches the display language on the screen.

◆ MENU (DVD VIDEO only)

You can select the desired language for the disc's menu.

◆ AUDIO (DVD VIDEO only)

Switches the language of the sound track. When you select "ORIGINAL," the language given priority in the disc is selected.

◆ SUBTITLE (DVD VIDEO only)

Switches the language of the subtitle recorded on the DVD VIDEO.

When you select "AUDIO FOLLOW," the language for the subtitles changes according to the language you selected for the sound track.

💡 Hint

If you select "OTHERS →" in "MENU," "SUBTITLE," or "AUDIO," select and enter a language code from "Language Code List" on page 74 using the number buttons.

Note

When you select a language in "MENU," "SUBTITLE," or "AUDIO" that is not recorded on a DVD VIDEO, one of the recorded languages will be automatically selected.

Settings for the Display

(SCREEN SETUP)

Choose settings according to the TV to be connected.

Select "SCREEN SETUP" in the Setup Display. To use the display, see "Using the Setup Display" (page 62).

The default settings are underlined.

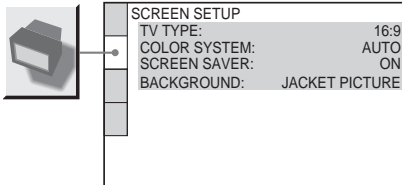

◆ TV TYPE

Selects the aspect ratio of the connected TV (4:3 standard or wide).

<u>16:9</u>	Select this when you connect a wide-screen TV or a TV with a wide mode function.
4:3 LETTER BOX	Select this when you connect a 4:3 screen TV. Displays a wide picture with bands on the upper and lower portions of the screen.
4:3 PAN SCAN	Select this when you connect a 4:3 screen TV. Automatically displays the wide picture on the entire screen and cuts off the portions that do not fit.

16:9



4:3 LETTER BOX



4:3 PAN SCAN

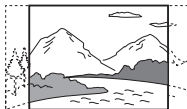

Note

Depending on the DVD, "4:3 LETTER BOX" may be selected automatically instead of "4:3 PAN SCAN" or vice versa.

◆ COLOR SYSTEM (VIDEO CD only)

Selects the colour system when you play a VIDEO CD.

<u>AUTO</u>	Outputs the video signal in the system of the VIDEO CD, either PAL or NTSC. If your TV is the DUAL system, select AUTO.
PAL	Changes the video signals of an NTSC VIDEO CD and outputs it in the PAL system.
NTSC	Changes the video signals of a PAL VIDEO CD and outputs it in the NTSC system.

Notes

- You cannot change the colour system for DVDs.
- You can change the colour system of this player according to the connected TV. See page 17.

◆ SCREEN SAVER

The screen saver image appears when you leave the player in pause or stop mode for 15 minutes, or when you play back a CD or DATA CD (MP3 audio) for more than 15 minutes. The screen saver will help prevent your display device from becoming damaged (ghosting). Press \blacktriangleright to turn off the screen saver.

<u>ON</u>	Turns on the screen saver.
OFF	Turns off the screen saver.

◆ BACKGROUND

Selects the background colour or picture on the TV screen in stop mode or while playing a CD or DATA CD (MP3 audio).

<u>JACKET PICTURE</u>	The jacket picture (still picture) appears, but only when the jacket picture is already recorded on the disc (CD-EXTRA, etc.). If the disc does not contain a jacket picture, the "GRAPHICS" picture appears.
GRAPHICS	A preset picture stored in the player appears.
BLUE	The background colour is blue.
BLACK	The background colour is black.

Custom Settings (CUSTOM SETUP)

Use this to set up playback related and other settings.

Select "CUSTOM SETUP" in the Setup Display. To use the display, see "Using the Setup Display" (page 62).

The default settings are underlined.

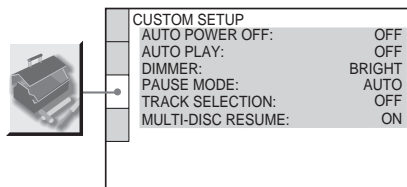

◆ AUTO POWER OFF (DVP-NS530 only)

Switches the Auto Power Off setting on or off.

<u>OFF</u>	Switches this function off.
ON	The player enters standby mode when left in stop mode for more than 30 minutes.

◆ AUTO PLAY

Switches the Auto Play setting on or off. This function is useful when the player is connected to a timer (not supplied).

<u>OFF</u>	Switches this function off.
ON	Automatically starts playback when the player is turned on.

◆ DIMMER

Adjusts the lighting of the front panel display.

<u>BRIGHT</u>	Makes the lighting bright.
DARK	Makes the lighting dark.

◆ PAUSE MODE (DVD VIDEO/DVD-RW only)

Selects the picture in pause mode.

<u>AUTO</u>	The picture, including subjects that move dynamically, is output with no jitter. Normally select this position.
FRAME	The picture, including subjects that do not move dynamically, is output in high resolution.

◆ TRACK SELECTION (DVD VIDEO only)

Gives the sound track which contains the highest number of channels priority when you play a DVD VIDEO on which multiple audio formats (PCM, MPEG audio, DTS, or Dolby Digital format) are recorded.

<u>OFF</u>	No priority given.
AUTO	Priority given.

Notes

- When you set the item to "AUTO," the language may change. The "TRACK SELECTION" setting has higher priority than the "AUDIO" settings in "LANGUAGE SETUP" (page 63).
- If you set "DTS" to "OFF" (page 67), the DTS sound track is not played even if you set "TRACK SELECTION" to "AUTO."
- If PCM, DTS, MPEG audio, and Dolby Digital sound tracks have the same number of channels, the player selects PCM, DTS, Dolby Digital, and MPEG audio sound tracks in this order.

◆ MULTI-DISC RESUME (DVD VIDEO/VIDEO CD only)

Switches the Multi-disc Resume setting on or off. Resume playback can be stored in memory for up to 6 different DVD VIDEO/VIDEO CD discs (page 29).

<u>ON</u>	Stores the resume setting in memory for up to six discs. (The settings remain in memory even if you select OFF.)
OFF	Does not store the resume setting in memory. Playback restarts at the resume point only for the current disc in the player.

Settings for the Sound

(AUDIO SETUP)

“AUDIO SETUP” allows you to set the sound according to the playback and connection conditions.

Select “AUDIO SETUP” in the Setup Display. To use the display, see “Using the Setup Display” (page 62).

The default settings are underlined.

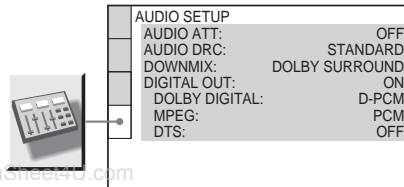

◆ AUDIO ATT (attenuation)

If the playback sound is distorted, set this item to “ON.” The player reduces the audio output level.

This function affects the output of the LINE OUT L/R (AUDIO) jacks

<u>OFF</u>	Normally, select this position.
ON	Select this when the playback sound from the speakers is distorted.

◆ AUDIO DRC (Dynamic Range Control) (DVD VIDEO/DVD-RW only)

Makes the sound clear when the volume is turned down when playing a DVD that conforms to “AUDIO DRC.” This affects the output from the following jacks:

- LINE OUT L/R (AUDIO) jacks
- DIGITAL OUT (OPTICAL or COAXIAL) jack only when “DOLBY DIGITAL” is set to “D-PCM” (page 67).

<u>STANDARD</u>	Normally select this position.
TV MODE	Makes the low sounds clear even if you turn the volume down.
WIDE RANGE	Gives you the feeling of being at a live performance.

◆ DOWNMIX (DVD VIDEO/DVD-RW only)

Switches the method for mixing down to 2 channels when you play a DVD which has rear sound elements (channels) or is recorded in Dolby Digital format. For details on the rear signal components, see “Displaying the audio information of the disc” (page 49). This function affects the output of the following jacks:

- LINE OUT L/R (AUDIO) jacks
- DIGITAL OUT (OPTICAL or COAXIAL) jack when “DOLBY DIGITAL” is set to “D-PCM” (page 67).

<u>DOLBY SURROUND</u>	Normally, select this position. Multi-channel audio signals are output to two channels for enjoying surround sounds.
NORMAL	Multi-channel audio signals are downmixed to two channels for use with your stereo.

◆ DIGITAL OUT

Selects if audio signals are output via the DIGITAL OUT (OPTICAL or COAXIAL) jack.

<u>ON</u>	Normally select this position. When you select “ON,” see “Setting the digital output signal” for further settings.
OFF	The influence of the digital circuit upon the analog circuit is minimal.

Setting the digital output signal

Switches the method of outputting audio signals when you connect a component such as an amplifier (receiver) or MD deck with a digital input jack.

For connection details, see page 19.

Select “DOLBY DIGITAL,” “MPEG,” and “DTS” after setting “DIGITAL OUT” to “ON.”

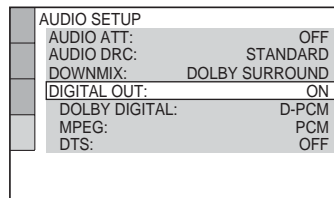

If you connect a component that does not conform to the selected audio signal, a loud noise (or no sound) will come out from the speakers, damaging your ears or speakers.

◆ **DOLBY DIGITAL (DVD VIDEO/DVD-RW only)**

Selects the type of Dolby Digital signal.

<u>D-PCM</u>	Select this when the player is connected to an audio component without a built-in Dolby Digital decoder. You can select whether the signals conform to Dolby Surround (Pro Logic) or not by making adjustments to the "DOWNMIX" item in "AUDIO SETUP" (page 66).
DOLBY DIGITAL	Select this when the player is connected to an audio component with a built-in Dolby Digital decoder.

◆ **MPEG (DVD VIDEO/DVD-RW only)**

Selects the type of MPEG audio signal.

<u>PCM</u>	Select this when the player is connected to an audio component without a built-in MPEG decoder. If you play MPEG audio sound tracks, the player outputs stereo signals via the DIGITAL OUT (OPTICAL or COAXIAL) jack.
MPEG	Select this when the player is connected to an audio component with a built-in MPEG decoder.

◆ **DTS (DVD VIDEO only)**

Selects whether or not to output DTS signals.

<u>OFF</u>	Select this when the player is connected to an audio component without a built-in DTS decoder.
ON	Select this when the player is connected to an audio component with a built-in DTS decoder.

Note

When you use the DIGITAL OUT (COAXIAL or OPTICAL) jack to listen to MPEG audio signals and set "MPEG" to MPEG in "AUDIO SETUP", no sound will come from your speakers if you select one of the TVS mode.

Troubleshooting

If you experience any of the following difficulties while using the player, use this troubleshooting guide to help remedy the problem before requesting repairs. Should any problem persist, consult your nearest Sony dealer.

Power

The power is not turned on.

- ➔ Check that the power cord is connected securely.

Picture

There is no picture/picture noise appears.

- ➔ Re-connect the connecting cord securely.
- ➔ The connecting cords are damaged.
- ➔ Check the connection to your TV (page 16) and switch the input selector on your TV so that the signal from the player appears on the TV screen.
- ➔ The disc is dirty or flawed.
- ➔ If the picture output from your player goes through your VCR to get to your TV or if you are connected to a combination TV/VIDEO player, the copy-protection signal applied to some DVD programmes could affect picture quality. If you still experience problems even when you connect your player directly to your TV, please try connecting your player to your TV's S VIDEO input (page 16).
- ➔ You are playing a disc recorded in a colour system that is different from your TV.
- ➔ If the colour system of your player does not match with that of your TV, change the colour system of the player. For details, see page 17. (You cannot change the colour system of the DVD disc itself.)
- ➔ You have set the player to progressive format (the PROGRESSIVE indicator lights up in blue) even though your TV cannot accept the progressive signal. In this case, press the PROGRESSIVE button on the front panel until the progressive indicator turns off (DVP-NS730P only).
- ➔ Even if your TV is compatible with progressive format 525p/625p signals, the

image may be affected when you set the player to progressive format. In this case, press the PROGRESSIVE button so that the PROGRESSIVE indicator turns off and the player is set to normal (interlace) format. (DVP-NS730P only)

Even though you set the aspect ratio in "TV TYPE" of "SCREEN SETUP," the picture does not fill the screen.

- ➔ The aspect ratio of the disc is fixed on your DVD.

Sound

There is no sound.

- ➔ Re-connect the connecting cord securely.
- ➔ The connecting cord is damaged.
- ➔ The player is connected to the wrong input jack on the amplifier (receiver) (page 21, 22, 23).
- ➔ The amplifier (receiver) input is not correctly set.
- ➔ The player is in pause mode or in Slow-motion Play mode.
- ➔ The player is in fast forward or fast reverse mode.
- ➔ If the audio signal does not come through the DIGITAL OUT (OPTICAL or COAXIAL) jack, check the audio settings (page 66).
- ➔ While playing a Super VCD on which the audio track 2 is not recorded, no sound will come out when you select "2:STEREO," "2:1/L," or "2:2/R."

Sound is noisy.

- ➔ When playing a CD with DTS sound tracks, noise will come from the LINE OUT L/R (AUDIO) jacks or DIGITAL OUT (OPTICAL or COAXIAL) jack (page 28).

Sound distortion occurs.

- ➔ Set "AUDIO ATT" in "AUDIO SETUP" to "ON" (page 66).

The sound volume is low.

- ➔ The sound volume is low on some DVDs. The sound volume may improve if you set "AUDIO DRC" to "TV MODE" (page 66).
- ➔ Set "AUDIO ATT" in "AUDIO SETUP" to "OFF" (page 66).

Operation

The remote does not function.

- ➔ The batteries in the remote are weak.
- ➔ There are obstacles between the remote and the player.
- ➔ The distance between the remote and the player is too far.
- ➔ The remote is not pointed at the remote sensor on the player.

The disc does not play.

- ➔ The disc is turned over.
Insert the disc with the playback side facing down on the disc tray.
- ➔ The disc is skewed.
- ➔ The player cannot play certain discs (page 7).
- ➔ The region code on the DVD does not match the player.
- ➔ Moisture has condensed inside the player (page 3).
- ➔ The player cannot play a recorded disc that is not correctly finalized (page 7).

The MP3 audio track cannot be played (page 33).

- ➔ The DATA CD is not recorded in the MP3 format that conforms to ISO 9660 Level 1/Level 2 or Joliet.
- ➔ The MP3 audio track does not have the extension “.MP3.”
- ➔ The data is not formatted in MP3 even though it has the extension “.MP3.”
- ➔ The data is not MPEG1 Audio Layer 3 data.
- ➔ The player cannot play audio tracks in MP3PRO format.

“Copyright lock” appears and the screen turns blue when playing a DVD-RW disc.

- ➔ Images taken from digital broadcasts, etc., may contain copy protection signals, such as complete copy protection signals, single copy signals, and restriction-free signals. When images that contain copy protection signals are played, a blue screen may appear instead of the images. It may take a while when looking for playable images.

The title of the MP3 audio album or track is not correctly displayed.

- ➔ The player can only display numbers and alphabet. Other characters are displayed as “?”.

The disc does not start playing from the beginning.

- ➔ Programme Play, Shuffle Play, Repeat Play, or A-B Repeat Play has been selected (page 35).
- ➔ Resume play has taken effect (page 29).

The player starts playing the disc automatically.

- ➔ The disc features an auto playback function.
- ➔ “AUTO PLAY” in “CUSTOM SETUP” is set to “ON” (page 65).

Playback stops automatically.

- ➔ While playing discs with an auto pause signal, the player stops playback at the auto pause signal.

You cannot perform some functions such as Stop, Search, Slow-motion Play, Repeat Play, Shuffle Play, or Programme Play.

- ➔ Depending on the disc, you may not be able to do some of the operations above. See the operating manual that comes with the disc.

The language for the sound track cannot be changed.

- ➔ Try using the DVD’s menu instead of the direct selection button on the remote (page 30).
- ➔ Multilingual tracks are not recorded on the DVD being played.
- ➔ The DVD prohibits the changing of the language for the sound track.

The subtitle language cannot be changed or turned off.

- ➔ Try using the DVD’s menu instead of the direct selection button on the remote (page 30).
- ➔ Multilingual subtitles are not recorded on the DVD being played.
- ➔ The DVD prohibits the changing of the subtitles.

The angles cannot be changed.

- ➔ Try using the DVD’s menu instead of the direct selection button on the remote (page 30).
- ➔ Multi-angles are not recorded on the DVD.
www.DataSheet4U.com

- ➔ The angle can only be changed when the “” indicator lights up on the front panel display (page 9).
- ➔ The DVD prohibits changing of the angles.

The player does not operate properly.

- ➔ When static electricity, etc., causes the player to operate abnormally, unplug the player.

5 numbers or letters are displayed on the screen and on the front panel display.

- ➔ The self-diagnosis function was activated. (See the table on page 70.)

The disc tray does not open and “LOCKED” appears on the front panel display.

- ➔ Child Lock is set (page 28).

The disc tray does not open and “TRAY LOCKED” appears on the front panel display.

- ➔ Contact your Sony dealer or local authorized Sony service facility.

“Data error” appears on the TV screen when playing a DATA CD.

- ➔ The MP3 audio track you want to play is broken.
- ➔ The data is not MPEG1 Audio Layer 3 data.

Self-diagnosis Function

(When letters/numbers appear in the display)

When the self-diagnosis function is activated to prevent the player from malfunctioning, a five-character service number (e.g., C 13 50) with a combination of a letter and four digits appears on the screen and the front panel display. In this case, check the following table.



First three characters of the service number	Cause and/or corrective action
C 13	The disc is dirty. ➔ Clean the disc with a soft cloth (page 7).
C 31	The disc is not inserted correctly. ➔ Re-insert the disc correctly.
E XX (xx is a number)	To prevent a malfunction, the player has performed the self-diagnosis function. ➔ Contact your nearest Sony dealer or local authorized Sony service facility and give the 5-character service number. Example: E 61 10

Glossary

Chapter (page 9)

Sections of a picture or a music feature that are smaller than titles. A title is composed of several chapters. Depending on the disc, no chapters may be recorded.

Dolby Digital (page 19, 67)

Digital audio compression technology developed by Dolby Laboratories. This technology conforms to 5.1-channel surround sound. The rear channel is stereo and there is a discrete subwoofer channel in this format. Dolby Digital provides the same 5.1 discrete channels of high quality digital audio found in "Dolby Digital" theatre surround sound systems. Good channel separation is realized because all of the channel data are recorded discretely and little deterioration is realized because all channel data processing is digital.

Dolby Surround (Pro Logic) (page 19)

Audio signal processing technology that Dolby Laboratories developed for surround sound. When the input signal contains a surround component, the Pro Logic process outputs the front, centre and rear signals. The rear channel is monaural.

DTS (page 19, 67)

Digital audio compression technology that Digital Theater Systems, Inc. developed. This technology conforms to 5.1-channel surround sound. The rear channel is stereo and there is a discrete subwoofer channel in this format. DTS provides the same 5.1 discrete channels of high quality digital audio. Good channel separation is realized because all of the channel data is recorded discretely and little deterioration is realized because all channel data processing is digital.

DVD VIDEO (page 6)

A disc that contains up to 8 hours of moving pictures even though its diameter is the same as a CD.

The data capacity of a single-layer and single-sided DVD is 4.7 GB (Giga Byte), which is 7 times that of a CD. The data capacity of a double-layer and single-sided DVD is 8.5

GB, a single-layer and double-sided DVD is 9.4 GB, and double-layer and double-sided DVD is 17GB.

The picture data uses the MPEG 2 format, one of the worldwide standards of digital compression technology. The picture data is compressed to about 1/40 (average) of its original size. The DVD also uses a variable rate coding technology that changes the data to be allocated according to the status of the picture. Audio information is recorded in a multi-channel format, such as Dolby Digital, allowing you to enjoy a more real audio presence.

Furthermore, various advanced functions such as the multi-angle, multilingual, and Parental Control functions are provided with the DVD.

DVD-RW (page 6)

A DVD-RW is a recordable and rewritable disc that is the same size as a DVD VIDEO. The DVD-RW has two different modes: VR mode and Video mode. DVD-RWs created in Video mode have the same format as a DVD VIDEO, while discs created in VR (Video Recording) mode allow the contents to be programmed or edited.

DVD+RW (page 6)

A DVD+RW (plus RW) is a recordable and rewritable disc. DVD+RWs use a recording format that is comparable to the DVD VIDEO format.

Film based software, Video based software (page 18)

DVDs can be classified as Film based or Video based software. Film based DVDs contain the same images (24 frames per second) that are shown at movie theaters. Video based DVDs, such as television dramas or sit-coms, displays images at 30 frames/60 fields (25 frames/50 fields) per second.

Index (CD)/Video Index (VIDEO CD) (page 12)

A number that divides a track into sections to easily locate the point you want on a CD or VIDEO CD. Depending on the disc, no index may be recorded.

Interlace format (page 18)

Interlace format shows every other line of an image as a single “field” and is the standard method for displaying images on television. The even number field shows the even numbered lines of an image, and the odd numbered field shows the odd numbered lines of an image.

MPEG audio (page 19, 67)

International standard coding system used to compress audio digital signals authorized by ISO/IEC. MPEG 1 conforms to up to 2-channel stereo. MPEG 2, used on DVDs, conforms to up to 7.1-channel surround.

Progressive format (page 18)

Compared to the Interlace format that alternately shows every other line of an image (field) to create one frame, the Progressive format shows the entire image at once as a single frame. This means that while the Interlace format can show 25 or 30 frames (50-60 fields) in one second, the Progressive format can show 50-60 frames in one second. The overall picture quality increases and still images, text, and horizontal lines appear sharper. This player is compatible with the 525 or 625 progressive format.

Scene (page 9)

On a VIDEO CD with PBC (playback control) functions, the menu screens, moving pictures and still pictures are divided into sections called “scenes.”

Title (page 9)

The longest section of a picture or music feature on a DVD, movie, etc., in video software, or the entire album in audio software.

Track (page 9)

Sections of a picture or a music feature on a CD or VIDEO CD (the length of a song).

Specifications

System

Laser: Semiconductor laser

Signal format system: NTSC/PAL (See page 17 to switch)

Audio characteristics

Frequency response: DVD VIDEO (PCM 96 kHz): 2 Hz to 44 kHz (± 1.0 dB)/DVD VIDEO (PCM 48 kHz): 2 Hz to 22 kHz (± 0.5 dB)/CD: 2 Hz to 20 kHz (± 0.5 dB)

Signal-to-noise ratio (S/N ratio): 115 dB (LINE OUT L/R (AUDIO) jacks only)

Harmonic distortion: 0.003 %

Dynamic range: DVD VIDEO: 103 dB/CD: 99 dB

Wow and flutter: Less than detected value ($\pm 0.001\%$ W PEAK)

The signals from LINE OUT L/R (AUDIO) jacks are measured. When you play PCM sound tracks with a 96 kHz sampling frequency, the output signals from the DIGITAL OUT (OPTICAL or COAXIAL) jack are converted to 48 kHz sampling frequency.

Outputs

(Jack name): Jack type/Output level/Load impedance)

LINE OUT (AUDIO): Phono jack/2 Vrms/ Over 10 kilohms

DIGITAL OUT (OPTICAL): Optical output jack/-18 dBm (wave length 660 nm)

DIGITAL OUT (COAXIAL): Phono jack/ 0.5 Vp-p/75 ohms

LINE OUT (VIDEO): Phono jack/1.0 Vp-p/ 75 ohms

S VIDEO OUT: 4-pin mini DIN/Y: 1.0 Vp-p, C: 0.3 Vp-p (PAL), 0.286 Vp-p (NTSC)/75 ohms

COMPONENT VIDEO OUT (Y, P_B/C_B, P_R/C_R)*: Phono jack/Y: 1.0 Vp-p, P_B/C_B, P_R/C_R: 0.7 Vp-p/75 ohms

COMPONENT VIDEO OUT (Y, C_B, C_R):** Phono jack/Y: 1.0 Vp-p, C_B, C_R: 0.7 Vp-p/75 ohms

* DVP-NS730P only

**DVP-NS530 only

General

Power requirements:

110 – 240 V AC, 50/60 Hz

110 V AC, 60 Hz

See page 2 for further information.

Power consumption: 13 W

Dimensions (approx.):

DVP-NS530:

430 × 55.5 × 244 mm (width/height/ depth) incl. projecting parts

DVP-NS730P:

430 × 55.5 × 237 mm (width/height/ depth) incl. projecting parts

Mass (approx.):

2.15 kg

Operating temperature: 5 °C to 35 °C

Operating humidity: 25 % to 80 %

Supplied accessories

See page 15.

Specifications and design are subject to change without notice.

ENERGY STAR® is a U.S. registered mark. As an ENERGY STAR® Partner, Sony Corporation has determined that this product meets the ENERGY STAR® guidelines for energy efficiency.

Language Code List

For details, see pages 48, 52, 63.

The language spellings conform to the ISO 639: 1988 (E/F) standard.

Code Language	Code Language	Code Language	Code Language
1027 Afar	1183 Irish	1347 Maori	1507 Samoan
1028 Abkhazian	1186 Scots Gaelic	1349 Macedonian	1508 Shona
1032 Afrikaans	1194 Galician	1350 Malayalam	1509 Somali
1039 Amharic	1196 Guarani	1352 Mongolian	1511 Albanian
1044 Arabic	1203 Gujarati	1353 Moldavian	1512 Serbian
1045 Assamese	1209 Hausa	1356 Marathi	1513 Siswati
1051 Aymara	1217 Hindi	1357 Malay	1514 Sesotho
1052 Azerbaijani	1226 Croatian	1358 Maltese	1515 Sundanese
1053 Bashkir	1229 Hungarian	1363 Burmese	1516 Swedish
1057 Byelorussian	1233 Armenian	1365 Nauru	1517 Swahili
1059 Bulgarian	1235 Interlingua	1369 Nepali	1521 Tamil
1060 Bihari	1239 Interlingue	1376 Dutch	1525 Telugu
1061 Bislama	1245 Inupiak	1379 Norwegian	1527 Tajik
1066 Bengali; Bangla	1248 Indonesian	1393 Occitan	1528 Thai
1067 Tibetan	1253 Icelandic	1403 (Afan)Oromo	1529 Tigrinya
1070 Breton	1254 Italian	1408 Oriya	1531 Turkmen
1079 Catalan	1257 Hebrew	1417 Punjabi	1532 Tagalog
1093 Corsican	1261 Japanese	1428 Polish	1534 Setswana
1097 Czech	1269 Yiddish	1435 Pashto; Pushto	1535 Tonga
1103 Welsh	1283 Javanese	1436 Portuguese	1538 Turkish
1105 Danish	1287 Georgian	1463 Quechua	1539 Tsonga
1109 German	1297 Kazakh	1481 Rhaeto-Romance	1540 Tatar
1130 Bhutani	1298 Greenlandic	1482 Kirundi	1543 Twi
1142 Greek	1299 Cambodian	1483 Romanian	1557 Ukrainian
1144 English	1300 Kannada	1489 Russian	1564 Urdu
1145 Esperanto	1301 Korean	1491 Kinyarwanda	1572 Uzbek
1149 Spanish	1305 Kashmiri	1495 Sanskrit	1581 Vietnamese
1150 Estonian	1307 Kurdish	1498 Sindhi	1587 Volapük
1151 Basque	1311 Kirghiz	1501 Sangho	1613 Wolof
1157 Persian	1313 Latin	1502 Serbo-Croatian	1632 Xhosa
1165 Finnish	1326 Lingala	1503 Singhalese	1665 Yoruba
1166 Fiji	1327 Laothian	1505 Slovak	1684 Chinese
1171 Faroese	1332 Lithuanian	1506 Slovenian	1697 Zulu
1174 French	1334 Latvian; Lettish		
1181 Frisian	1345 Malagasy		1703 Not specified

Index

Numerics

- 16:9 64
- 4:3 LETTER BOX 64
- 4:3 PAN SCAN 64
- 5.1 Channel Surround 19

A

- A-B REPEAT 38
- ADVANCED 46
- ALBUM 41
- Album 33
- ANGLE 52
- AUDIO 48, 63
- AUDIO ATT 66
- AUDIO DRC 66
- AUDIO SETUP 66
- AUTO PLAY 65
- AUTO POWER OFF 65

B

- BACKGROUND 64
- Batteries 15
- BIT RATE 46
- BNR 53

C

- CD 6, 27
- CHAPTER 41
- Chapter 9, 71
- CHAPTER VIEWER 43
- Child Lock 28
- COLOR SYSTEM
 - adjusting for VIDEO CD 64
 - changing the output signal 17
- Connecting 16
- Continuous play
 - CD/VIDEO CD 27
 - DVD 27
- Control Menu 12
- CUSTOM 62
- CUSTOM PARENTAL CONTROL 57
- CUSTOM PICTURE MODE 54
- CUSTOM SETUP 65

D

- DATA CD 6, 33
- DIGITAL OUT 66
- Digital output 66
- DIGITAL VIDEO ENHANCER 55
- DIMMER 65
- Display
 - Control Menu Display 12
 - Front panel display 9
 - Setup Display 62
- DOLBY DIGITAL 23, 48, 67,

71

- DOWNMIX 66
- DTS 23, 48, 67, 71
- DVD 6, 27, 71
- DVD+RW 6, 28, 71
- DVD's menu 30
- DVD-RW 6, 31, 71

F

- Fast forward 40
- Fast reverse 40
- Film based software 18, 71
- Freeze frame 41
- Front panel display 9

H

- Handling discs 7
- Hooking up 15

I

- INDEX 41
- Index 71
- Instant Replay 28
- Instant Search 28
- Interlace format 18, 72

L

- LANGUAGE SETUP 63
- LAYER 46
- Locating
 - a specific point by watching the TV screen 40

M

- MEMORY 54
- MENU 63
- MP3 6, 33
- MPEG 23, 48, 67, 72
- MULTI-DISC RESUME 29, 65

N

- NORMAL (INTERLACE) 18

O

- On-screen display
 - Control Menu Display 12
 - Setup Display 62
- ORIGINAL 31
- ORIGINAL/PLAY LIST 31
- OSD 63

P

- PARENTAL CONTROL 57
- PAUSE MODE 65
- PBC Playback 32
- PICTURE MODE 54
- PICTURE NAVIGATION 43
- PLAY LIST 31

- Playback Dial 41
- PRO LOGIC 22, 66, 71
- PROGRAM 35
- Programme Play 35
- PROGRESSIVE AUTO 18
- PROGRESSIVE FILM 18
- Progressive format 18, 72
- PROGRESSIVE VIDEO 18

Q

- QUICK 63
- Quick Setup 24, 63

R

- Remote 15, 61
- REPEAT 37
- Repeat Play 37
- RESET 63
- Resume Play 29

S

- S VIDEO output 16
- Scan 40
- SCENE 41
- Scene 9, 72
- SCREEN SAVER 64
- SCREEN SETUP 64
- Searching 40
- SETUP 62
- Setup Display 62
- SHUFFLE 36
- Shuffle Play 36
- Slow-motion Play 40
- Speakers
 - Hooking up 19
- SUBTITLE 52, 63
- SURROUND 19, 50

T

- TIME/TEXT 41, 44
- TITLE 41
- Title 9, 72
- TITLE VIEWER 43
- TOP MENU 30
- TRACK 41
- Track 9, 72
- TRACK SELECTION 65
- TRACK VIEWER 43
- Troubleshooting 68
- TV TYPE 64
- TVS (TV Virtual Surround) 50

U

- Usable discs 6

V

- Video based software 18, 71
- VIDEO CD 6, 27

www.DataSheet4U.com