

**LED Driver**

- Supplies stable bias current even at low battery voltage
- Ideal for stabilizing bias current of LEDs
- Negative temperature coefficient protects LEDs against thermal overload
- Suitable for 12V automotive applications

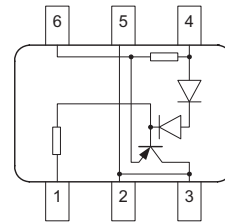
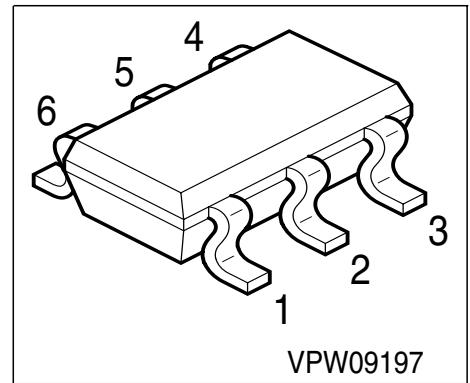

Type	Marking	Pin Configuration				Package
BCR405U	L5s	1 = GND	2;3;5 = $I_{out}$	4 = $V_S$	6 = $R_{ext}$	SC74

**Maximum Ratings**

Parameter	Symbol	Value	Unit
Source voltage	$V_S$	40	V
Output current $V_S = 10\text{ V}$	$I_{out}$	65	mA
Output voltage	$V_{out}$	38	V
Reverse voltage between all terminals	$V_R$	0.5	
Total power dissipation, $T_S = 117\text{ °C}$	$P_{tot}$	500	mW
Junction temperature	$T_j$	150	°C
Storage temperature	$T_{stg}$	-65 ... 150	

**Thermal Resistance**

Parameter	Symbol	Value	Unit
Junction - soldering point <sup>1)</sup>	$R_{thJS}$	50	K/W

<sup>1)</sup>For calculation of  $R_{thJA}$  please refer to Application Note Thermal Resistance

**Electrical Characteristics at  $T_A=25^\circ\text{C}$ , unless otherwise specified**

Parameter	Symbol	Values			Unit
		min.	typ.	max.	
<b>Characteristics</b>					
Supply current $V_S = 10\text{ V}$	$I_S$	-	500	900	$\mu\text{A}$
Output current $V_S = 10\text{ V}$	$I_{out}$	45	50	55	mA

**DC Characteristics with stabilized LED load**

Lowest sufficient battery voltage overhead $I_{out} > 18\text{mA}$	$V_{Smin}$	-	1.4	-	V
Voltage drop ( $V_S - V_{CE}$ ) $I_{out} = 20\text{ mA}$	$V_{drop}$	-	0.8	-	
Output current change versus $T_A$ $V_S = 10\text{ V}$	$\Delta I_{out}/I_{out}$	-	-0.15	-	%/K
Output current change versus $V_S$ $V_S = 10\text{ V}$	$\Delta I_{out}/I_{out}$	-	1	-	%/V

**Total power dissipation  $P_{tot} = f(T_S)$**

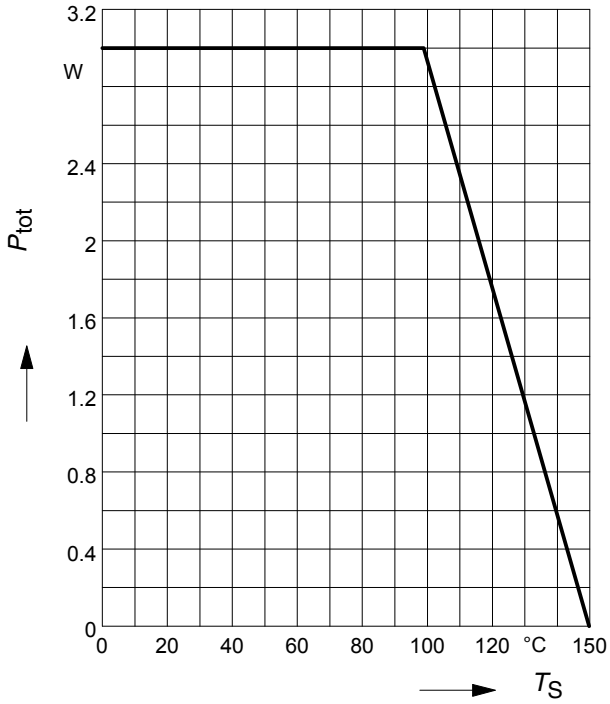

**Permissible Pulse Load  $R_{thJS} = f(t_p)$**

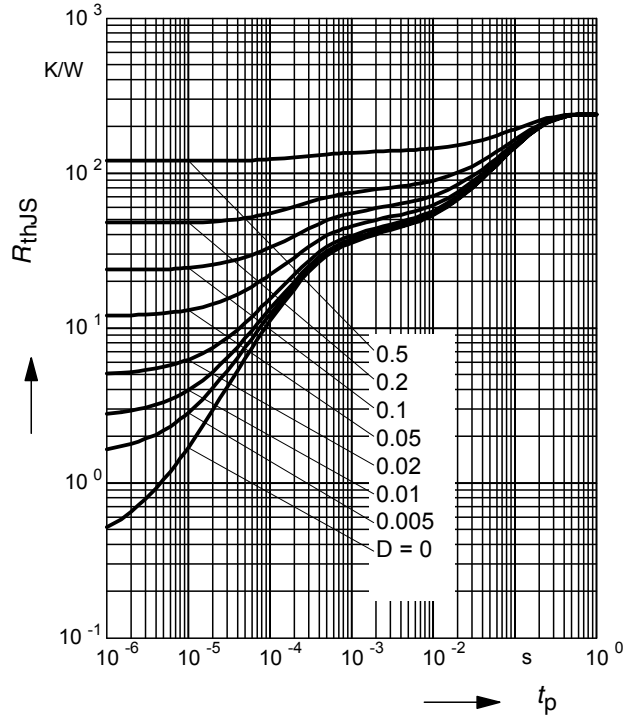

**Permissible Pulse Load**

$P_{totmax} / P_{totDC} = f(t_p)$

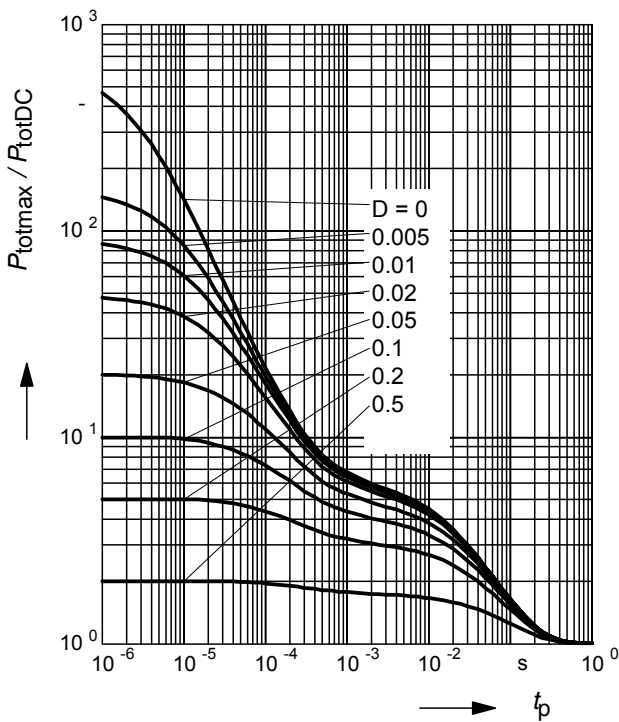

**Output current versus supply voltage**

$I_{out} = f(V_S); R_{ext} = \text{Parameter}$

$V_S - V_{out} = 1.4 \text{ V}$

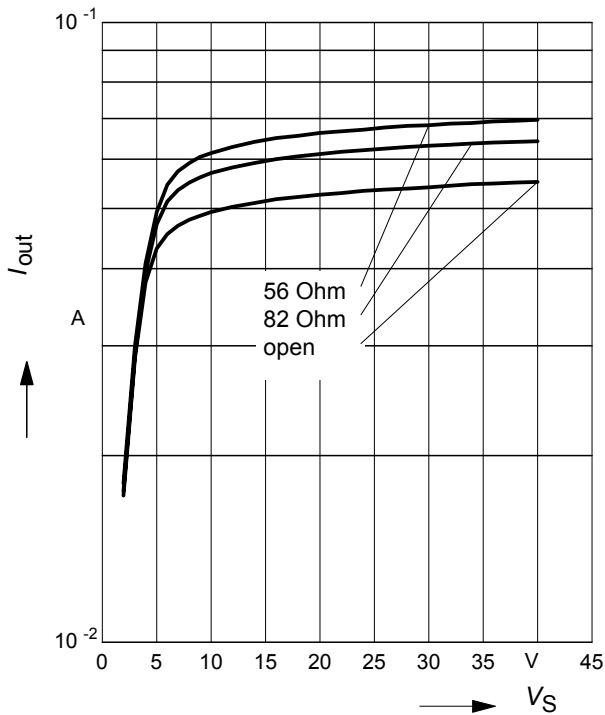

**Supply current versus supply voltage**

$I_S = f(V_S)$

$T_A = \text{Parameter}$

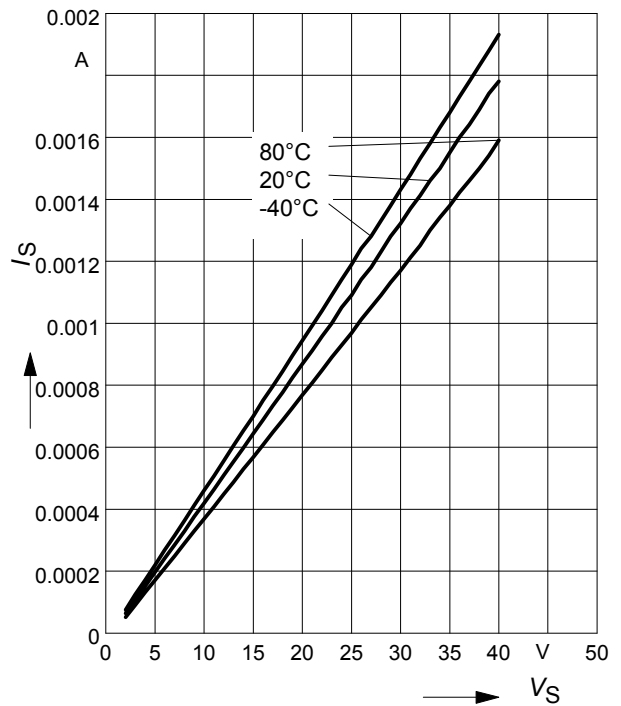

**Output current versus supply voltage**

$I_{out} = f(V_S), T_A = 20^\circ\text{C}$

$V_S - V_{out}$  as Parameter

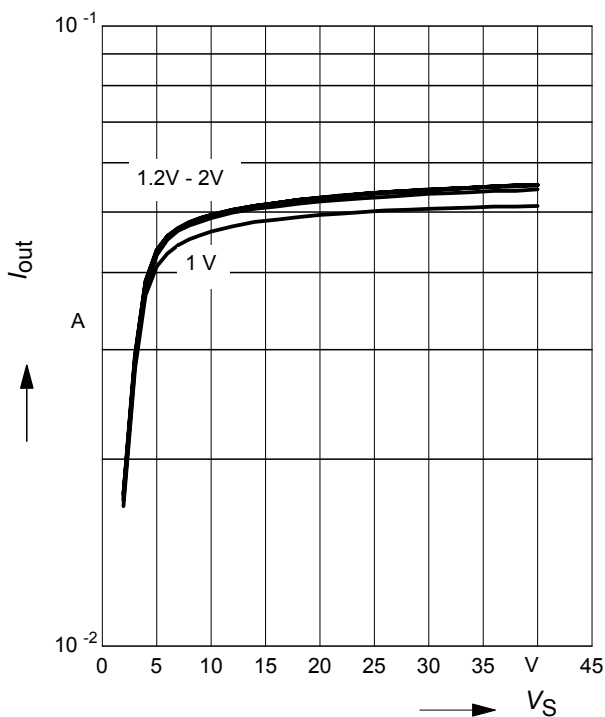

**Output current versus supply voltage**

$I_{out} = f(V_S), V_S - V_{out} = 1.4 \text{ V}$

$T_A = \text{Parameter}$

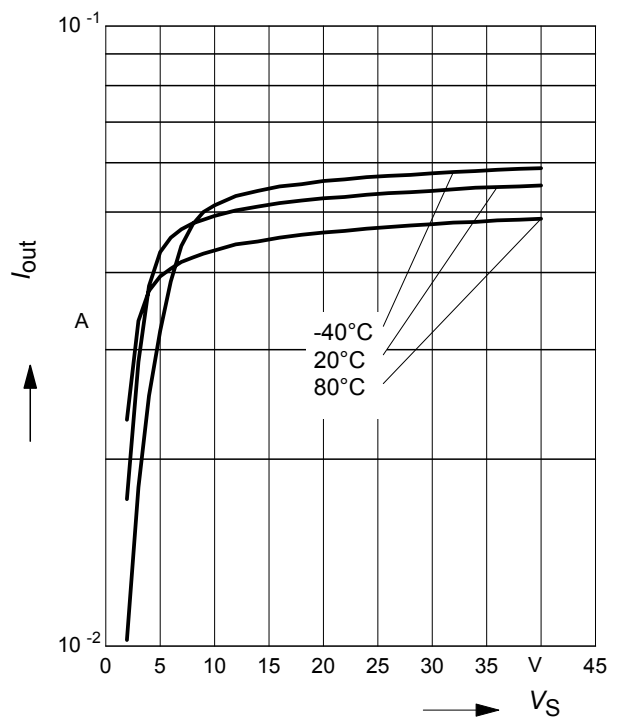

**Output current versus external resistor**

$I_{out} = (R_{ext}), V_S = 10V, V_S - V_{out} = 1.4 V$

$T_A = \text{Parameter}$

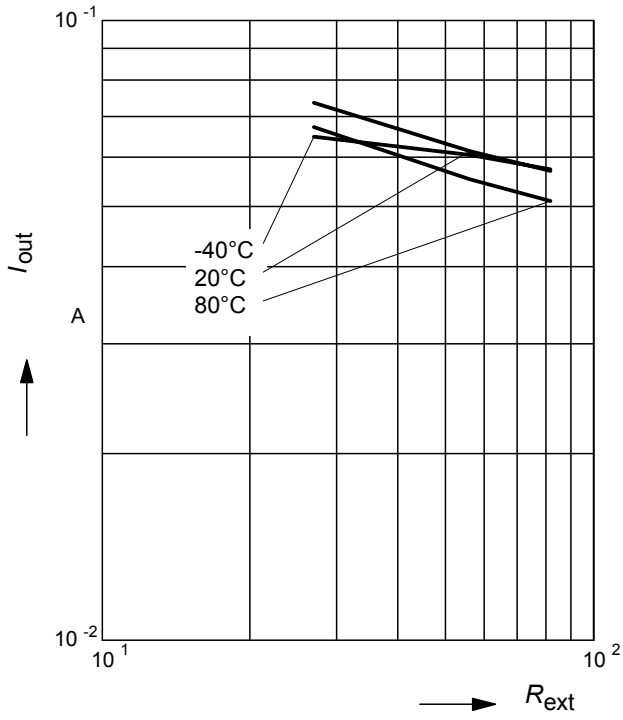

**Application Circuit:**

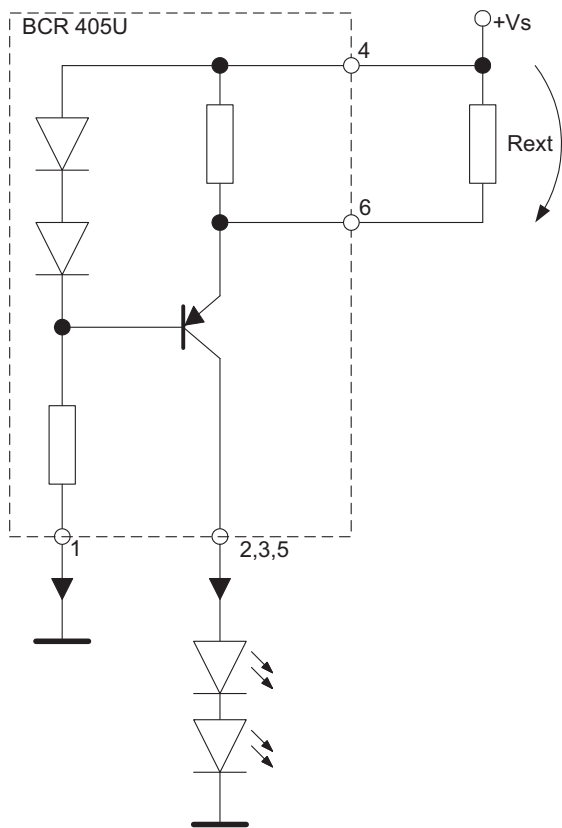

**Published by Infineon Technologies AG,  
St.-Martin-Strasse 53,  
81669 München**

**© Infineon Technologies AG 2004.  
All Rights Reserved.**

**Attention please!**

The information herein is given to describe certain components and shall not be considered as a guarantee of characteristics.

Terms of delivery and rights to technical change reserved.

We hereby disclaim any and all warranties, including but not limited to warranties of non-infringement, regarding circuits, descriptions and charts stated herein.

**Information**

For further information on technology, delivery terms and conditions and prices please contact your nearest Infineon Technologies Office ([www.infineon.com](http://www.infineon.com)).

**Warnings**

Due to technical requirements components may contain dangerous substances. For information on the types in question please contact your nearest Infineon Technologies Office.

Infineon Technologies Components may only be used in life-support devices or systems with the express written approval of Infineon Technologies, if a failure of such components can reasonably be expected to cause the failure of that life-support device or system, or to affect the safety or effectiveness of that device or system. Life support devices or systems are intended to be implanted in the human body, or to support and/or maintain and sustain and/or protect human life. If they fail, it is reasonable to assume that the health of the user or other persons may be endangered.