

## Typical Applications

Prescaler for DC to C Band PLL Applications:

- UNII, Point-to-Point & VSAT Radios
- 802.11a & HiperLAN WLAN
- Fiber Optic
- Cellular / 3G Infrastructure

## Features

- SSB Phase Noise: -153 dBc/Hz @100KHz
- Wide Bandwidth
- Output Power: -1 dBm
- Single DC Supply: +5V @ 80 mA
- MS8G SMT Package

## Functional Diagram

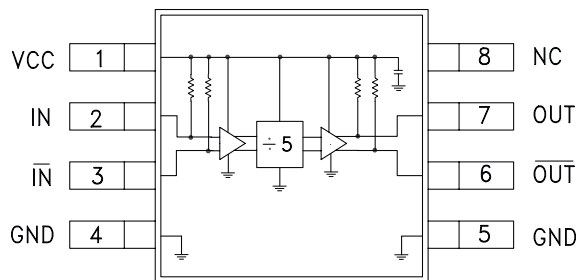

## General Description

The HMC438MS8G & HMC438MS8GE are low noise Divide-by-5 Static Dividers utilizing InGaP GaAs HBT technology in low cost 8 lead surface mount plastic packages. This device operates from DC (with a square wave input) to 7.0 GHz input frequency from a single +5.0V DC supply. The low additive SSB phase noise of -153 dBc/Hz at 100 kHz offset helps the user maintain good system noise performance.

## Electrical Specifications, $T_A = +25^\circ\text{C}$ , 50 Ohm System, $V_{CC} = 5V$

| Parameter                        | Conditions                            | Min. | Typ. | Max. | Units  |
|----------------------------------|---------------------------------------|------|------|------|--------|
| Maximum Input Frequency          |                                       | 7.0  | 7.5  |      | GHz    |
| Minimum Input Frequency          | Sine Wave Input [1]                   |      | 0.1  |      | GHz    |
| Input Power Range                | $F_{in} = 1$ to 5 GHz                 | -12  | -15  | +12  | dBm    |
|                                  | $F_{in} = 5$ to 6 GHz                 | -12  | -15  | +10  | dBm    |
|                                  | $F_{in} = 6$ to 7 GHz                 | -10  | -15  | +5   | dBm    |
| Output Power                     |                                       | -4   | -1   |      | dBm    |
| Reverse Leakage                  | Both RF Outputs Terminated            |      | -50  |      | dBm    |
| SSB Phase Noise (100 kHz offset) | $P_{in} = 0$ dBm, $F_{in} = 6$ GHz    |      | -153 |      | dBc/Hz |
| Output Transition Time           | $P_{in} = 0$ dBm, $F_{out} = 882$ MHz |      | 100  |      | ps     |
| Supply Current ( $I_{CC}$ )      |                                       |      | 80   |      | mA     |

1. Divider will operate down to DC for square-wave input signal.



v03.0705



# HMC438MS8G / 438MS8GE

## SMT GaAs HBT MMIC DIVIDE-BY-5, DC - 7.0 GHz

Input Sensitivity Window, T= 25 °C

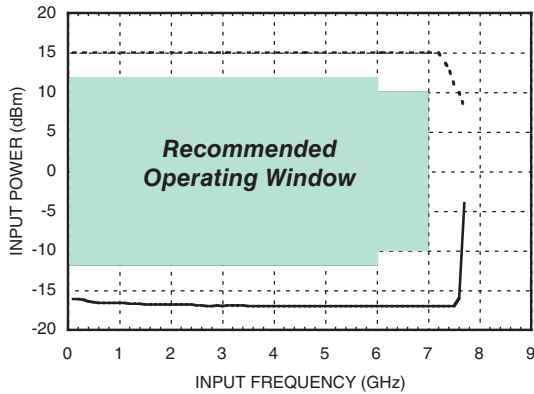

Input Sensitivity Window vs. Temperature

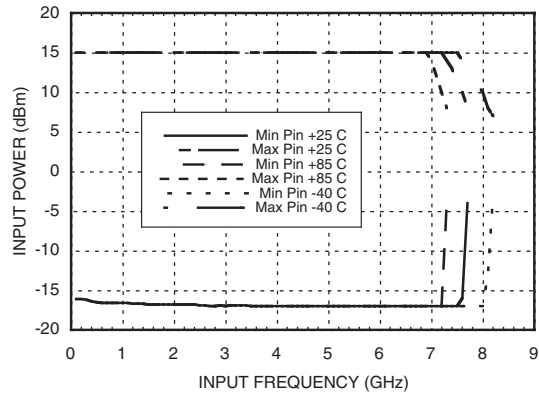

Output Power vs. Temperature

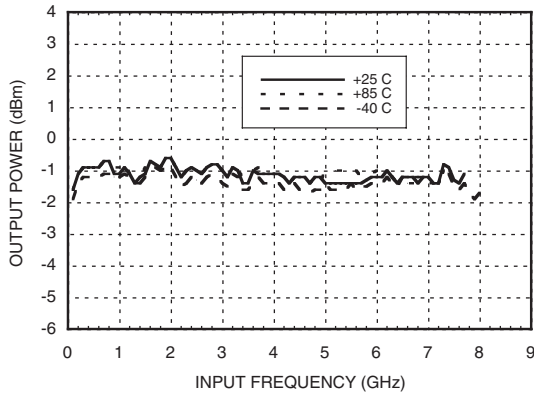

SSB Phase Noise Performance,  
Pin= 0 dBm, Fin= 6GHz, T= 25 °C

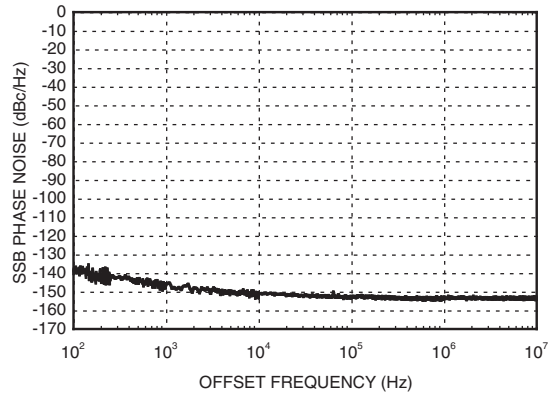

Output Harmonic Content, Pin= 0 dBm, T= 25 °C

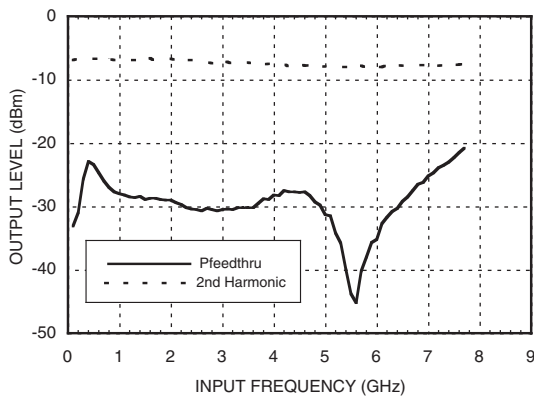

Reverse Leakage, Pin= 0 dBm, T= 25 °C

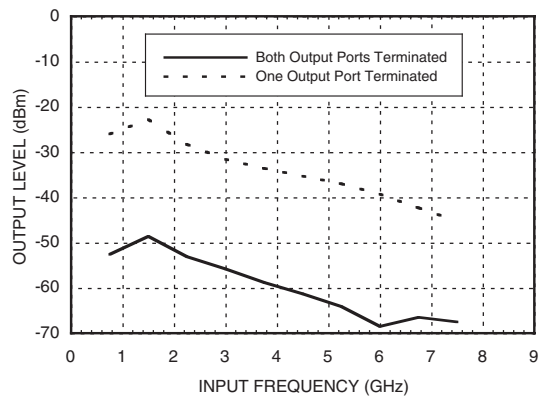

For price, delivery, and to place orders, please contact Hittite Microwave Corporation:  
 20 Alpha Road, Chelmsford, MA 01824 Phone: 978-250-3343 Fax: 978-250-3373  
 Order On-line at [www.hittite.com](http://www.hittite.com)



MICROWAVE CORPORATION v03.0705



# HMC438MS8G / 438MS8GE

**SMT GaAs HBT MMIC  
DIVIDE-BY-5, DC - 7.0 GHz**

**Output Voltage Waveform,  
Pin= 0 dBm, Fout= 882 MHz, T= 25 °C**

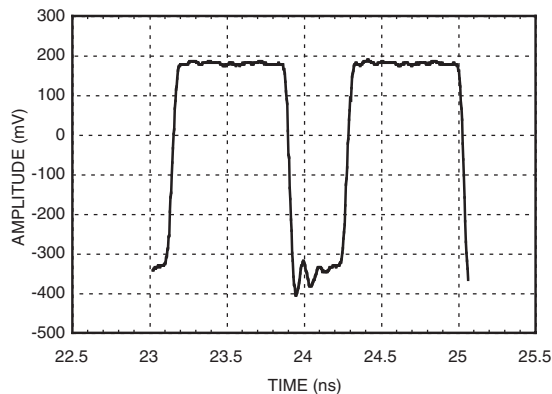

## Absolute Maximum Ratings

|  |                |
|--|----------------|
| RF Input (Vcc= +5V)  | +13 dBm        |
| Vcc  | +5.5V          |
| Maximum Channel Temperature                                  | 135 °C         |
| Continuous Pdiss (T=85 °C)<br>(derate 11.3mW/°C above 92 °C) | 485mW          |
| Storage Temperature  | -65 to +150 °C |
| Operating Temperature  | -40 to +85 °C  |

DC blocking capacitors are required at RF input and RF output ports. Choose value for lowest frequency of operation.

## Typical Supply Current vs. Vcc

| Vcc (V) | Icc (mA) |
|---------|----------|
| 4.75    | 75       |
| 5.0     | 80       |
| 5.25    | 87       |

Note: Divider will operate over full voltage range shown above



**ELECTROSTATIC SENSITIVE DEVICE  
OBSERVE HANDLING PRECAUTIONS**

## Outline Drawing

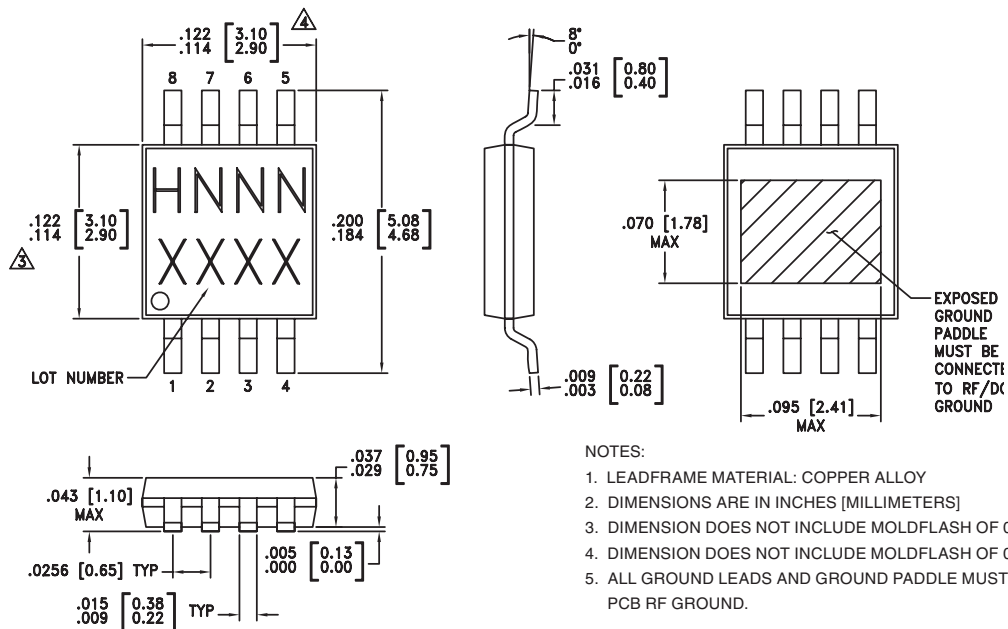

## Package Information

| Part Number | Package Body Material                              | Lead Finish   | MSL Rating          | Package Marking <sup>[3]</sup> |
|-------------|--|---------------|---------------------|--------------------------------|
| HMC438MS8G  | Low Stress Injection Molded Plastic                | Sn/Pb Solder  | MSL1 <sup>[1]</sup> | H438<br>XXXX                   |
| HMC438MS8GE | RoHS-compliant Low Stress Injection Molded Plastic | 100% matte Sn | MSL1 <sup>[2]</sup> | H438<br>XXXX                   |

[1] Max peak reflow temperature of 235 °C

[2] Max peak reflow temperature of 260 °C

[3] 4-Digit lot number XXXX

For price, delivery, and to place orders, please contact Hittite Microwave Corporation:  
 20 Alpha Road, Chelmsford, MA 01824 Phone: 978-250-3343 Fax: 978-250-3373  
 Order On-line at [www.hittite.com](http://www.hittite.com)



MICROWAVE CORPORATION v03.0705



# HMC438MS8G / 438MS8GE

**SMT GaAs HBT MMIC  
DIVIDE-BY-5, DC - 7.0 GHz**

## Pin Description

| Pin Number | Function                | Description   | Interface Schematic |
|------------|-------------------------|---|---------------------|
| 1          | Vcc                     | Supply voltage 5V ± 0.25V.  |                     |
| 2          | IN                      | RF input must be DC blocked.  |                     |
| 3          | $\overline{\text{IN}}$  | RF input 180° out of phase with pin 2 for differential operation. AC ground for single ended operation. |                     |
| 4, 5       | GND                     | All ground leads and ground paddle must be soldered to PCB RF/DC ground.                                |                     |
| 6          | $\overline{\text{OUT}}$ | Divided output 180° out of phase with pin 7.  |                     |
| 7          | OUT                     | Divided Output.   |                     |
| 8          | N/C                     | No Connection   |                     |

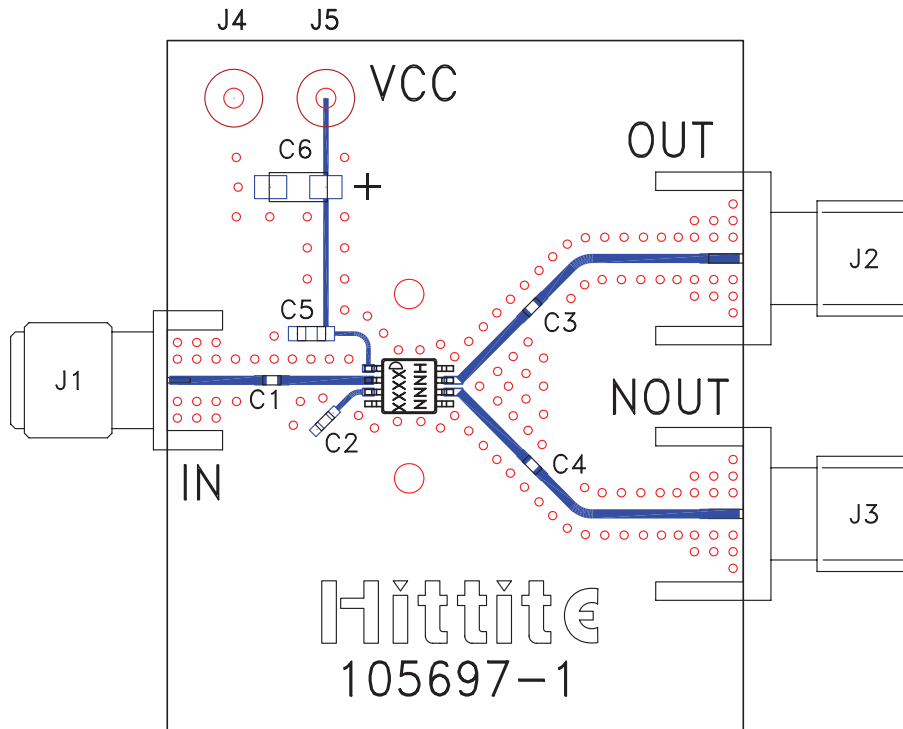
**Evaluation PCB**

**List of Materials for Evaluation PCB 105786 [1]**

| Item    | Description                          |
|---------|--------------------------------------|
| J1 - J3 | PCB Mount SMA RF Connector           |
| J4, J5  | DC Pin                               |
| C1 - C4 | 100 pF Capacitor, 0402 Pkg.          |
| C5      | 10,000 pF Capacitor, 0603 Pkg.       |
| C6      | 4.7 $\mu$ F Tantalum Capacitor       |
| U1      | HMC438MS8G / HMC438MS8GE Divide-by-5 |
| PCB [2] | 105697 Eval Board                    |

[1] Reference this number when ordering complete evaluation PCB

[2] Circuit Board Material: Rogers 4350

The circuit board used in the final application should use RF circuit design techniques. Signal lines should have 50 ohm impedance while the package ground leads and backside ground slug should be connected directly to the ground plane similar to that shown. A sufficient number of via holes should be used to connect the top and bottom ground planes. The evaluation circuit board shown is available from Hittite upon request. This evaluation board is designed for single ended input testing. J2 and J3 provide differential output signals.



MICROWAVE CORPORATION v03.0705



# HMC438MS8G / 438MS8GE

**SMT GaAs HBT MMIC**  
**DIVIDE-BY-5, DC - 7.0 GHz**

## Application Circuit

