

149-200 to 149-213



Illuminated switches, pushbutton switches EMF for panel mounting

Standards and approvals
SEV 1005, VDE 0630, SEMKO 124, CSA C22.2/14
UL 508, CEE 24



EMF 18 x 24



EMF 18 x 18



EMF ø 18



1-pole



2-pole



3-pole



4-pole

General description

EMF is a complete illuminated pushbutton switches programme for screw on panel mounting (mounting hole diameter 16 mm). The forms of lenses are available in the dimensions rectangular 18 x 24 mm, square 18 x 18 mm and round diameter 18 mm. The pushbutton switches are equipped with snap action element and 1-4 contact blocks.

Each contact block can be used as N C or N O or change-over contact (for change-over contact ext. connection between terminals 2 and 4).

Contacts in one section must be same polarity.

EMF illuminated pushbutton switches can be fitted with contactless elements on request.

Separation of the individual switching elements by contactless units permits high and low voltages to be applied to the same pushbutton switch. The 4 tin-plated terminals of each block are absolutely flux-proof.

The lenses of EMF are available in 11 different colours and can be illuminated by Midget-Groove T 1 1/4 incandescent lamps or LED. The switching positions of the alternate version of the pushbutton switches is always indicated by the position of lens.

By use of neon lamps with external resistor ≤ 250 V~, please consider relevant standards and approvals.

Approvals

SEV-Approval	Nr 87 660112 01	UL-Recognition	No E 73407
VDE-Certificate	Nr 1827	CSA-Certification	No 47016
SEMKO-Approval	Nr 8647105		

Technical data

Switch system	each contact block has one double break, snap acting switching mechanism
Switch mode	momentary or alternate action, 1- to 4-pole
Contact material	silver for applications > 15 V and 20 mA
Operating travel	3,2 mm
Actuating force	> 1,5 N
Initial contact resistance (new)	< 10 mΩ test current 1 A AC according to IEC 341-1, test 1
Breaking capacity (at ohmic load)	250 V / 5 A AC, 250 V / 0,2 A DC
Mechanical lifetime	> 2 x 10 ⁶ operations
Electrical lifetime (at ohmic load)	
5 A / 250 V AC	> 50'000 operations
4 A / 250 V AC	> 60'000 operations
2 A / 250 V AC	> 200'000 operations
1 A / 250 V AC	> 400'000 operations
Storage temperatur	-40 °C up to +85 °C
Operating temperatur	-40 °C up to +55 °C (with incandescent lamp) -40 °C up to +85 °C (without incandescent lamp)
Vibration resistance	IEC 68-2-6 test Fc, details on request
Insulation resistance	> 10 ⁴ MΩ 500 V DC according to IEC 341-1
Test voltage	> 4'000 V, 50 Hz, 1 min. between metal plate and terminals
Protection class	suitable for mounting in equipments with protection class II/IEC 536
Degree of protection	IP40 IEC 529 (mounted from the front side)
Climate category	GVF with lamp, GPF without lamp according to DIN 40040
Terminals	Max diameter of wire 2 x 0,8 mm Max diameter of stranded cable 0,75 mm ²
Solderability	350 °C, 2 s, IEC 68-2-20, test Ta, method 2
Soldering heat resistance	350 °C, 10 s, IEC 68-2-20, test Tb, method 2
Materials	temperature resistant thermoplastic, contact housing moulded in electrical high-grade thermosetting plastic current-carrying parts, Cu-alloy

149-200 F 213

SCHURTER



Illuminated switches pushbutton switches EMF

Case colour black

Standards and approvals
SEV 1005, VDE 0630, SEMKO 124, CSA C22.2/14
UL 508, CEE 24

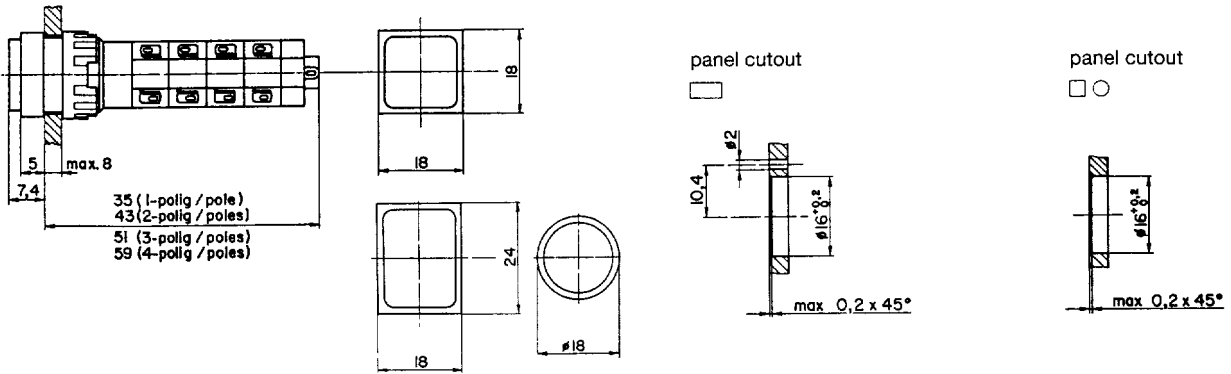
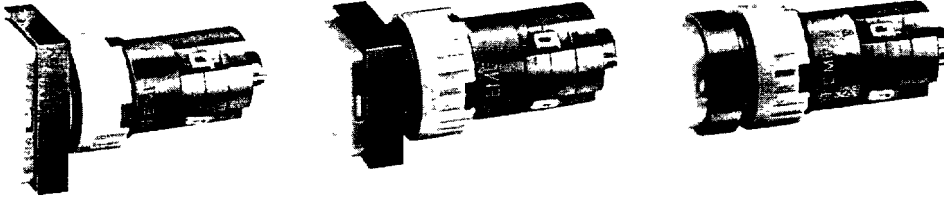

Order No. for EMF without lenses, lamps etc., accessories see page 40-42

Description	Type	Type	Contact diagram (button not depressed) for change-over contact ext connections between 2 and 4	Length A [mm]	Order No Shape of case		
					□ 18 x 24	□ 18 x 18	○ ø 18
Illuminated pushbutton 1-pole, momentary action	1			35	0041 2301	0041 2311	0041.2321
Illuminated pushbutton 2-pole, momentary action	2			43	0041 2302	0041 2312	0041 2322
Illuminated pushbutton 3-pole, momentary action	3			51	0041 2303	0041 2313	0041.2323
Illuminated pushbutton 4-pole, momentary action	4			59	0041 2304	0041.2314	0041 2324
Illuminated pushbutton 1-pole, alternate action		1		35	0041 2351	0041.2361	0041 2371
Illuminated pushbutton 2-pole, alternate action		2		43	0041.2352	0041 2362	0041 2372
Illuminated pushbutton 3-pole, alternate action		3		51	0041 2353	0041 2363	0041 2373
Illuminated pushbutton 4-pole, alternate action		4		59	0041 2354	0041 2364	0041 2374

Contacts in one section must be same polarity

Suitable holders AF for signal lamps see page 66



Availability: ex warehouse or prompt delivery



Accessories EMF























Lenses / plate inserts



Colours	 18 x 24	 18 x 18	 ø 18
clear glass	0854 0581	0854 0601	0854 0621
clear red	0854 0582	0854 0602	0854 0622
clear green	0854 0583	0854 0603	0854 0623
clear yellow	0854 0584	0854 0604	0854 0624
clear blue	0854 0585	0854 0605	0854 0625
pearl	0854 0591	0854 0611	0854 0631
diffused red	0854 0592	0854 0612	0854 0632
diffused green	0854 0593	0854 0613	0854 0633
diffused yellow	0854 0594	0854 0614	0854 0634
diffused blue •	0854 0595	0854 0615	0854 0635
black •	0854 0596	0854 0616	0854 0636

• not recommended for illuminated switches

Order No. legend plate inserts

	18 x 24	18 x 18	ø 18		18 x 24	18 x 18	ø 18
	0854 0871	0854 0872	0854.0873		0854 1414	0854 1614	0854 1814
	0854 1402	0854.1602	0854 1802		0854 1415	0854 1615	0854 1815
	0854 1403	0854 1603	0854.1803		0854 1416	0854.1616	0854.1816
	0854 1404	0854.1604	0854 1804		0854.1417	0854.1617	0854.1817
	0854.1405	0854 1605	0854 1805		0854 1418	0854.1618	0854.1818
	0854 1406	0854 1606	0854.1806		0854 1419	0854.1619	0854 1819
	0854.1407	0854 1607	0854.1807		0854.1420	0854.1620	0854.1820
	0854 1408	0854 1608	0854 1808		0854 1421	0854.1621	0854 1821
	0854 1409	0854.1609	0854.1809		0854.1422	0854.1622	0854 1822
	0854 1410	0854.1610	0854 1810		0854.1423	0854 1623	0854.1823
	0854 1411	0854 1611	0854 1811				
	0854.1412	0854 1612	0854 1812				
	0854 1413	0854 1613	0854 1813				

The white / translucent legend plate with black inscriptions use only with clear glass lenses.

Other legends on plate inserts available on request.
Availability: ex warehouse or prompt delivery



Accessories EMF

Incandescent lamps
LED's
Mounting tools

Incandescent lamp T 1³/₄ Midget Groove



Order No.

	voltage	consumption	brightness	lifetime AC	DC
0913 4001	6.3 V	200 mA	40 MSCP	50'000 h	25'000 h
0913 4002	14 V	80 mA	20 MSCP	15'000 h	7'000 h
0913 4003	28 V	40 mA	20 MSCP	10'000 h	5'000 h
0913 4004	48 V	25 mA	20 MSCP	5'000 h	2'000 h
0913 4005	60 V	20 mA	30 MSCP	1'000 h	1'000 h
0913.4006	24 V	50 mA	18 MSCP	10'000 h	5'000 h

The use of incandescent lamps > 60 V is limited by different standards

Series resistors for incandescent lamps and capacitors for the reduction of lamp voltage available on request. The permission for other ratings must be clarified according to the international testing laboratories. Incandescent lamps with lower power consumption on request

LED T 1³/₄ Midget Groove

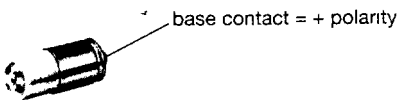

Order No.

	Operating voltage U_B [V]	Reverse voltage U_R [V]	Operating current I_F [mA]	Operating temperat °C	Storage temperat. °C	Power dissipation P_{tot} [mW]	Peak wave length λ_{peak} [nm]	Reverse current I_R [µA]	Lumin intensity I_v [mcd]
0925 0104 red	6	8	30	-25 °C up to +70 °C	-25 °C up to +85 °C	250	700	100	7
0925 0105 green	6	8	30			250	555	100	30
0925 0106 yellow	6	8	30			250	570	100	22
0925 0107 red	12	16	15			250	700	100	7
0925 0108 green	12	16	15			250	555	100	30
0925 0109 yellow	12	16	15			250	570	100	22
0925 0110 red	28	16	10			300	700	100	7
0925.0111 green	28	16	10			300	555	100	30
0925.0112 yellow	28	16	10			300	570	100	22

Lamp extractor



Order No.

0853.0621

Availability: ex warehouse or prompt delivery

Mounting key



Order No.

0853.0622



Accessories EMF

Protection shields

Protection shield against inadvertent operation (thermoplastic)

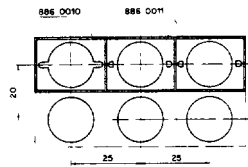
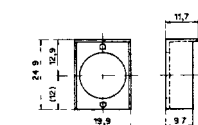
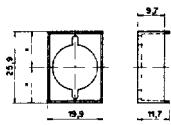

Protection shield against inadvertent operation

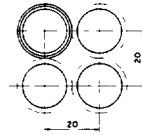
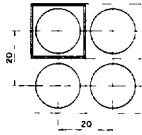
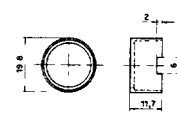
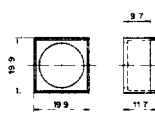

Order No.

0886.0010 single mounting

0886 0011 in-line mounting

Order No.

0886 0012

0886 0013

Splash guards IP64 (PVC)

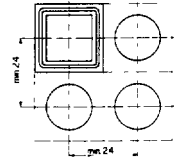
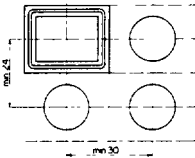
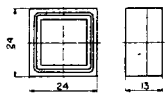
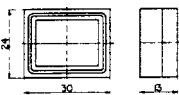
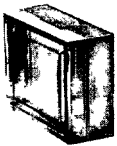

Protection cap (lockable with lead seal)

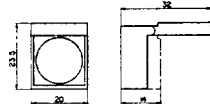
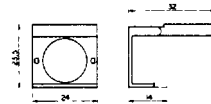

Order No.

0886 0002

0886 0001

Order No.

0886 0004

0886 0003

Blanking plate black



Order No.

0886 0005 (18 x 24)

0886.0006 (18 x 18)

Availability: ex warehouse or prompt delivery

Blanking plate black



Order No.

0886 0007 (Ø 18)



Signal-lamps AF for panel mounting

Standards and approvals
SEV 1060, VDE 0710, SEMKO 103, UL 508, CSA C 22.2-14



- Holders **AF** for interchangeable incandescent lamps and LED's (T1^{3/4} Midget Groove)
- Available for voltages 6,3 V, 14 V, 28 V, 48 V and 60 V
- Technical data of incandescent and LED's see page 41

- Selector chart of technical data see page 48
- Case colour black
- Combination terminals for solder or PCB mounting
- Accessories for lamp holders have to be ordered separately, see page 40-42 (EMF)
- Approvals.

SEV-Approval	No 91 550698 01
VDE-Mark	No. 42343
SEMKO-Approval	No 8410021
UL-Recognition	No E 73407
CSA-Certification	No LR 47016

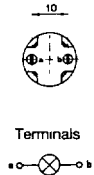
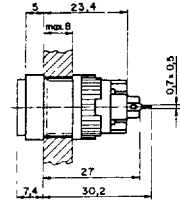
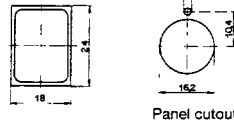
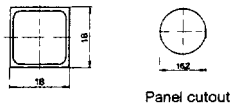
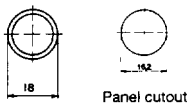
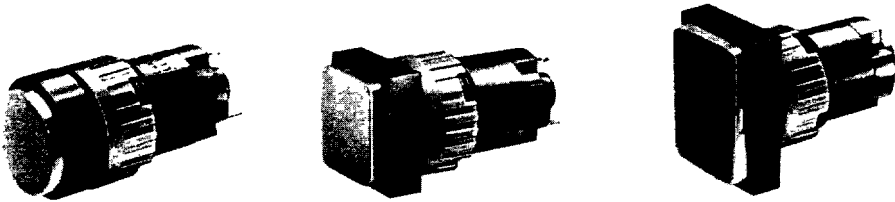

Order No.

Socket AF	ø 18 mm	Socket AF	□ 18 x 18 mm
0035 5521		0035.5511	

Order No.

Socket AF	□ 18 x 24 mm
0035 5501	

Availability: ex warehouse or prompt delivery