

**PC-17K1 • PC-17K2 • PC-17K4**

These Photocouplers consist of a Gallium Arsenide Infrared Emitting Diode and a Silicon NPN Phototransistor per a channel  
 The PC-17K1 has one channel in a 4-pin DIP package  
 The PC-17K2 has two channels in a 8-pin DIP package  
 The PC-17K4 has four channels in a 16-pin DIP package

**FEATURES**

- Small Package Size
- Collector-Emitter Voltage : Min.35V
- Current Transfer Ratio : Min.50% (at  $I_F=5mA, V_{CE}=5V$ )
- Electrical Isolation Voltage : AC5000Vrms
- Creepage/Clearance between Input and Output : Min. 7.0mm
- UL Recognized File No. E107486

**APPLICATIONS**

- Interface between two circuits of different potential
- Vending Machine, Cordless Phone, Key Phone, Fax, Motor Control
- Programmable Logic Control
- Power Supply
- Computer Terminals

**DIMENSION**

(Unit : mm)

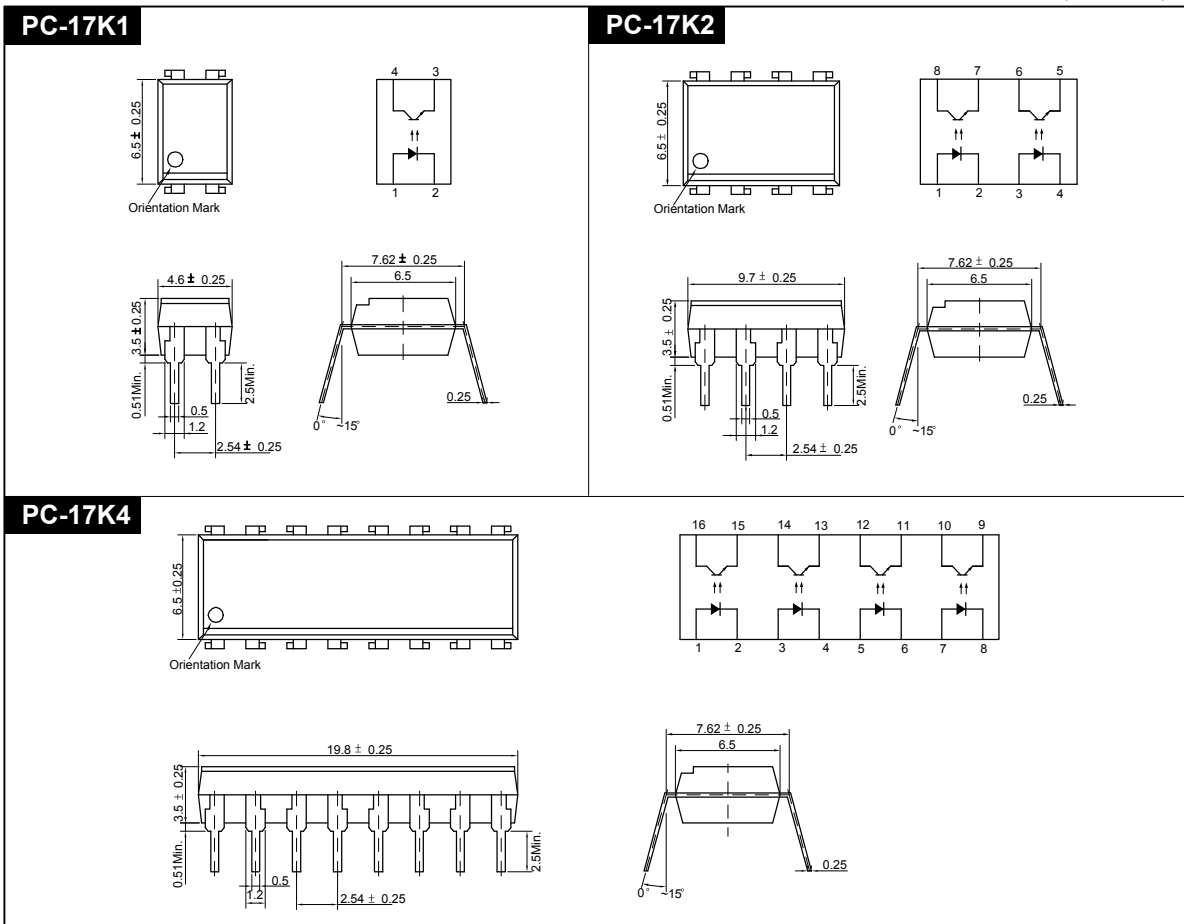

## PC-17K1 • PC-17K2 • PC-17K4

### MAXIMUM RATINGS

(Ta=25°C)

Parameter		Symbol	Rating	Unit
Input	Forward Current	IF	50	mA
	Reverse Voltage	VR	5	V
	Peak Forward Current <sup>*1</sup>	IFP	1	A
	Power Dissipation	PD	70	mW
Output	Collector-Emitter Breakdown Voltage	BVCEO	35 <sup>*4</sup>	V
	Emitter-Collector Breakdown Voltage	BVECO	6	V
	Collector Current	IC	50	mA
	Collector Power Dissipation	PC	150	mW
Input to Output Isolation Voltage <sup>*2</sup>		Viso	AC5000	Vrms
Storage Temperature		Tstg	-55~+125	°C
Operating Temperature		Topr	-30~+100	°C
Lead Soldering Temperature <sup>*3</sup>		Tsol	260	°C
Total Power Dissipation		Ptot	200	mW

\*1. Input current with 100 $\mu$ s pulse width, 1% duty cycle

\*2. Measured at RH=40~60% for 1min

\*3. 1/16 inch form case for 10sec

\*4. Customer Option

### ELECTRO-OPTICAL CHARACTERISTICS

(Ta=25°C, unless otherwise noted)

Parameter		Symbol	Condition	Min.	Typ.	Max.	Unit.
Input	Forward Voltage	VF	IF=10mA	-	1.15	1.30	V
	Reverse Current	IR	VR=5V	-	-	10	$\mu$ A
	Capacitance	CT	V=0, f=1MHz	-	30	-	pF
Output	Collector-Emitter Breakdown Voltage	BVCEO	IC=0.5mA	35	-	-	V
	Emitter-Collector Breakdown Voltage	BVECO	IE=0.1mA	6	-	-	V
	Collector Dark Current	ICEO	IF=0, VCE=24V	-	-	100	nA
	Capacitance	CCE	VCE=0, f=1MHz	-	10	-	pF
Coupled	Current Transfer Ratio <sup>*5</sup>	CTR	IF=5mA, VCE=5V	50	-	600	%
	Collector-Emitter Saturation Voltage	VCE(SAT)	IF=5mA, IC=1mA	-	0.15	0.4	V
	Input-Output Capacitance	CIO	V=0, f=1MHz	-	1	-	pF
	Input-Output Isolation Resistance	RIO	RH=40~60%, V=500V	-	10 <sup>11</sup>	-	$\Omega$
	Rise Time	tr	VCE=5V, RL=100 $\Omega$	-	4	-	$\mu$ s
	Fall Time	tf	IC=2mA	-	4	-	$\mu$ s

\*5. CTR=(IC/IF) X 100 (%)

**PC-17K1 • PC-17K2 • PC-17K4**

**Forward Current vs. Ambient Temperature**

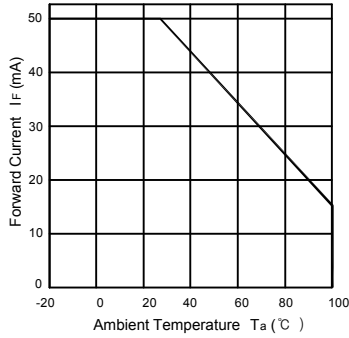

**Collector Power Dissipation vs. Ambient Temperature**

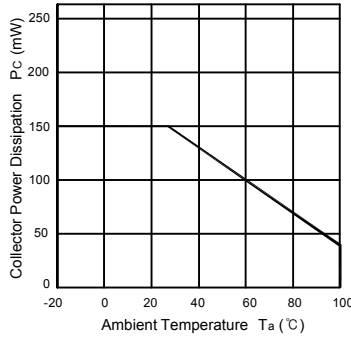

**Forward Current vs. Forward Voltage**

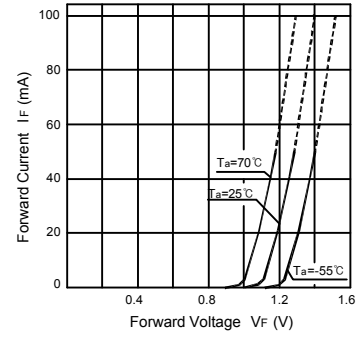

**Collector Current vs. Collector-Emitter Voltage**

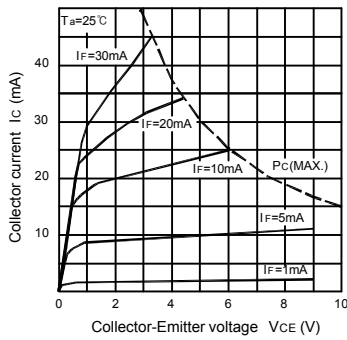

**Dark Current vs. Ambient Temperature**

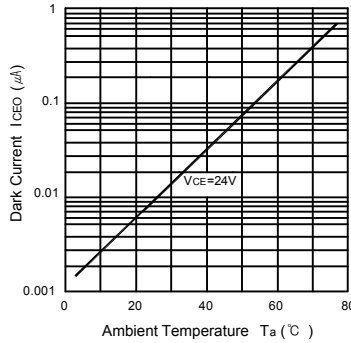

**Collector Current vs. Ambient Temperature**

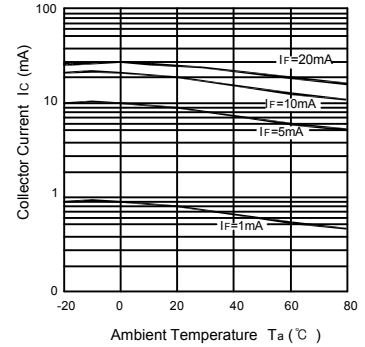

**Response Time vs. Load Resistance**

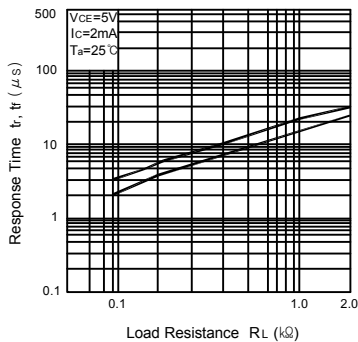

**Collector Current vs. Forward Current**

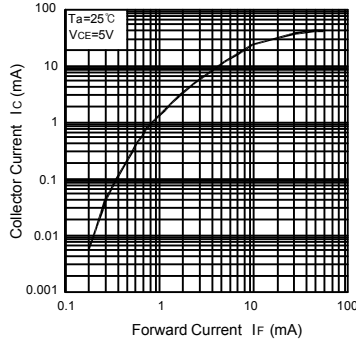

**Switching Time Test Circuit**

