

## **512Mb DDR2 SDRAM**

**HY5PS12421(L)F**  
**HY5PS12821(L)F**  
**HY5PS121621(L)F**

## Revision History

Rev.	History	Draft Date
0.0	Preliminary	Apr.2003
0.1	Changed Some Description & IDD Spec	Jun. 2003
0.2	Editorial clean up, Fixed CL3~6 & AL0~5, Defined IDD Specifications, Added Package outline, added Self-Refresh High temperature Entry, changed tRAS spec. for DDR2 400	Dec. 2003
1.0	Transferred Functional description, command truth table pages and Some contents of Operating conditions to <Device Operation>	Jul. 2004
	Modified IDD specifications.	Nov. 2004
	Changed IDD Spec.(IDD2P & IDD6)	Feb. 2005

---

## Contents

### 1. Description

#### 1.1 Device Features and Ordering Information

##### 1.1.1 Key Features

##### 1.1.2 Ordering Information

##### 1.1.3 Ordering Frequency

#### 1.2 Pin configuration

#### 1.3 Pin Description

### 2. Maximum DC ratings

#### 2.1 Absolute Maximum DC Ratings

#### 2.2 Operating Temperature Condition

### 3. AC & DC Operating Conditions

#### 3.1 DC Operating Conditions

##### 5.1.1 Recommended DC Operating Conditions(SSTL\_1.8)

##### 5.1.2 ODT DC Electrical Characteristics

#### 3.2 DC & AC Logic Input Levels

##### 3.2.1 Input DC Logic Level

##### 3.2.2 Input AC Logic Level

##### 3.2.3 AC Input Test Conditions

##### 3.2.4 Differential Input AC Logic Level

##### 3.2.5 Differential AC output parameters

#### 3.3 Output Buffer Levels

##### 3.3.1 Output AC Test Conditions

##### 3.3.2 Output DC Current Drive

##### 3.3.3 OCD default characteristics

#### 3.4 IDD Specifications & Measurement Conditions

#### 3.5 Input/Output Capacitance

### 4. AC Timing Specifications

### 5. Package Dimensions

# 1. Description

## 1.1 Device Features & Ordering Information

### 1.1.1 Key Features

- VDD=1.8V
- VDDQ=1.8V +/- 0.1V
- All inputs and outputs are compatible with SSTL\_18 interface
- Fully differential clock inputs (CK, /CK) operation
- Double data rate interface
- Source synchronous-data transaction aligned to bidirectional data strobe (DQS,  $\overline{DQS}$ )
- Differential Data Strobe ( $\overline{DQS}$ ,  $\overline{DQS}$ )
- Data outputs on DQS,  $\overline{DQS}$  edges when read (edged DQ)
- Data inputs on DQS centers when write(centered DQ)
- On chip DLL align DQ, DQS and  $\overline{DQS}$  transition with CK transition
- DM mask write data-in at the both rising and falling edges of the data strobe
- All addresses and control inputs except data, data strobes and data masks latched on the rising edges of the clock
- Programmable CAS latency 3, 4, 5 and 6 supported
- Programmable additive latency 0, 1, 2, 3, 4 and 5 supported
- Programmable burst length 4/8 with both nibble sequential and interleave mode
- Internal four bank operations with single pulsed RAS
- Auto refresh and self refresh supported
- tRAS lockout supported
- 8K refresh cycles /64ms
- JEDEC standard 60ball FBGA(x4/x8) & 84ball FBGA(x16)
- Full strength driver option controlled by EMRS
- On Die Termination supported
- Off Chip Driver Impedance Adjustment supported
- Read Data Strobe supported (x8 only)
- Self-Refresh High Temperature Entry

### Ordering Information

Part No.	Configuration	Package
HY5PS12421(L)F-X*	128Mx4	60Ball
HY5PS12821(L)F-X*	64Mx8	
HY5PS121621(L)F-X*	32Mx16	84Ball

### Operating Frequency

Grade	tCK(ns)	CL	tRCD	tRP	Unit
-E3	5	3	3	3	Clk
-C4	3.75	4	4	4	Clk
-Y5	3	5	5	5	Clk

**Note:** -X\* is the speed bin, refer to the Operation Frequency table for complete Part No.

## 1.2 Pin Configuration & Address Table

### 128Mx4 DDR2 Pin Configuration

1	2	3		7	8	9
VDD	NC	VSS	A	VSSQ	$\overline{\text{DQS}}$	VDDQ
NC	VSSQ	DM	B	DQS	VSSQ	NC
VDDQ	DQ1	VDDQ	C	VDDQ	DQ0	VDDQ
NC	VSSQ	DQ3	D	DQ2	VSSQ	NC
VDDL	VREF	VSS	E	VSSDL	CK	VDD
	CKE	$\overline{\text{WE}}$	F	$\overline{\text{RAS}}$	$\overline{\text{CK}}$	ODT
NC	BA0	BA1	G	$\overline{\text{CAS}}$	$\overline{\text{CS}}$	
	A10	A1	H	A2	A0	VDD
VSS	A3	A5	J	A6	A4	
	A7	A9	K	A11	A8	VSS
VDD	A12	NC	L	NC	A13	

### ROW AND COLUMN ADDRESS TABLE

ITEMS	128Mx4
# of Bank	4
Bank Address	BA0, BA1
Auto Precharge Flag	A10/AP
Row Address	A0 - A13
Column Address	A0-A9, A11
Page size	1 KB

## 64Mx8 DDR2 PIN CONFIGURATION

1	2	3		7	8	9
VDD	NU, $\overline{\text{RDQS}}$	VSS	A	VSSQ	$\overline{\text{DQS}}$	VDDQ
DQ6	VSSQ	DM, RDQS	B	DQS	VSSQ	DQ7
VDDQ	DQ1	VDDQ	C	VDDQ	DQ0	VDDQ
DQ4	VSSQ	DQ3	D	DQ2	VSSQ	DQ5
VDDL	VREF	VSS	E	VSSDL	CK	VDD
	CKE	$\overline{\text{WE}}$	F	$\overline{\text{RAS}}$	$\overline{\text{CK}}$	ODT
NC	BA0	BA1	G	$\overline{\text{CAS}}$	$\overline{\text{CS}}$	
	A10	A1	H	A2	A0	VDD
VSS	A3	A5	J	A6	A4	
	A7	A9	K	A11	A8	VSS
VDD	A12	NC	L	NC	A13	

### ROW AND COLUMN ADDRESS TABLE

ITEMS	64Mx8
# of Bank	4
Bank Address	BA0, BA1
Auto Precharge Flag	A10/AP
Row Address	A0 - A13
Column Address	A0-A9
Page size	1 KB

## 32Mx16 DDR2 PIN CONFIGURATION

1	2	3		7	8	9
VDD	NC	VSS	A	VSSQ	$\overline{\text{UDQS}}$	VDDQ
DQ14	VSSQ	UDM	B	UDQS	VSSQ	DQ15
VDDQ	DQ9	VDDQ	C	VDDQ	DQ8	VDDQ
DQ12	VSSQ	DQ11	D	DQ10	VSSQ	DQ13
VDD	NC	VSS	E	VSSQ	$\overline{\text{LDQS}}$	VDDQ
DQ6	VSSQ	LDM	F	LDQS	VSSQ	DQ7
VDDQ	DQ1	VDDQ	G	VDDQ	DQ0	VDDQ
DQ4	VSSQ	DQ3	H	DQ2	VSSQ	DQ5
VDDL	VREF	VSS	J	VSSDL	CK	VDD
	CKE	$\overline{\text{WE}}$	K	$\overline{\text{RAS}}$	$\overline{\text{CK}}$	ODT
NC	BA0	BA1	L	$\overline{\text{CAS}}$	$\overline{\text{CS}}$	
	A10	A1	M	A2	A0	VDD
VSS	A3	A5	N	A6	A4	
	A7	A9	P	A11	A8	VSS
VDD	A12	NC	R	NC	NC	

### ROW AND COLUMN ADDRESS TABLE

ITEMS	32Mx16
# of Bank	4
Bank Address	BA0, BA1
Auto Precharge Flag	A10/AP
Row Address	A0 - A12
Column Address	A0-A9
Page size	2 KB

### 1.3 PIN DESCRIPTION

PIN	TYPE	DESCRIPTION
CK, $\overline{CK}$	Input	Clock: CK and $\overline{CK}$ are differential clock inputs. All address and control input signals are sampled on the crossing of the positive edge of CK and negative edge of $\overline{CK}$ . Output (read) data is referenced to the crossings of CK and $\overline{CK}$ (both directions of crossing).
CKE	Input	Clock Enable: CKE HIGH activates, and CKE LOW deactivates internal clock signals, and device input buffers and output drivers. Taking CKE LOW provides PRECHARGE POWER DOWN and SELF REFRESH operation (all banks idle), or ACTIVE POWER DOWN (row ACTIVE in any bank). CKE is synchronous for POWER DOWN entry and exit, and for SELF REFRESH entry. CKE is asynchronous for SELF REFRESH exit. After $V_{REF}$ has become stable during the power on and initialization sequence, it must be maintained for proper operation of the CKE receiver. For proper self-refresh entry and exit, $V_{REF}$ must be maintained to this input. CKE must be maintained high throughout READ and WRITE accesses. Input buffers, excluding CK, $\overline{CK}$ and CKE are disabled during POWER DOWN. Input buffers, excluding CKE are disabled during SELF REFRESH.
$\overline{CS}$	Input	Chip Select : All commands are masked when $\overline{CS}$ is registered HIGH. $\overline{CS}$ provides for external bank selection on systems with multiple banks. $\overline{CS}$ is considered part of the command code.
ODT	Input	On Die Termination Control : ODT(registered HIGH) enables on die termination resistance internal to the DDR2 SDRAM. When enabled, ODT is only applied to DQ, DQS, $\overline{DQS}$ , RDQS, $\overline{RDQS}$ , and DM signal for x4,x8 configurations. For x16 configuration ODT is applied to each DQ, UDQS/ $\overline{UDQS}$ , LDQS/ $\overline{LDQS}$ , UDM and LDM signal. The ODT pin will be ignored if the Extended Mode Register(EMRS(1)) is programmed to disable ODT.
$\overline{RAS}$ , $\overline{CAS}$ , $\overline{WE}$	Input	Command Inputs: $\overline{RAS}$ , $\overline{CAS}$ and $\overline{WE}$ (along with $\overline{CS}$ ) define the command being entered.
DM (LDM, UDM)	Input	Input Data Mask : DM is an input mask signal for write data. Input Data is masked when DM is sampled High coincident with that input data during a WRITE access. DM is sampled on both edges of DQS, Although DM pins are input only, the DM loading matches the DQ and DQS loading. For x8 device, the function of DM or RDQS/ $\overline{RDQS}$ is enabled by EMRS command.
BA0 - BA2	Input	Bank Address Inputs: BA0 - BA2 define to which bank an ACTIVE, Read, Write or PRECHARGE command is being applied(For 256Mb and 512Mb, BA2 is not applied). Bank address also determines if the mode register or extended mode register is to be accessed during a MRS or EMRS cycle.
A0 -A15	Input	Address Inputs: Provide the row address for ACTIVE commands, and the column address and AUTO PRECHARGE bit for READ/WRITE commands to select one location out of the memory array in the respective bank. A10 is sampled during a precharge command to determine whether the PRECHARGE applies to one bank (A10 LOW) or all banks (A10 HIGH). If only one bank is to be precharged, the bank is selected by BA0-BA2. The address inputs also provide the op code during MODE REGISTER SET commands.
DQ	Input/Output	Data input / output : Bi-directional data bus
DQS, $\overline{DQS}$ (UDQS), $\overline{UDQS}$ (LDQS), $\overline{LDQS}$ (RDQS), $\overline{RDQS}$	Input/Output	<p>Data Strobe : Output with read data, input with write data. Edge aligned with read data, centered in write data. For the x16, LDQS correspond to the data on DQ0~DQ7; UDQS corresponds to the data on DQ8~DQ15. For the x8, an RDQS option using DM pin can be enabled via the EMRS(1) to simplify read timing. The data strobes DQS, LDQS, UDQS, and RDQS may be used in single ended mode or paired with optional complementary signals <math>\overline{DQS}</math>, <math>\overline{LDQS}</math>, <math>\overline{UDQS}</math> and <math>\overline{RDQS}</math> to provide differential pair signaling to the system during both reads and writes. An EMRS(1) control bit enables or disables all complementary data strobe signals.</p> <p>In this data sheet, "differential DQS signals" refers to any of the following with A10 = 0 of EMRS(1)        x4 DQS/<math>\overline{DQS}</math>        x8 DQS/<math>\overline{DQS}</math> if EMRS(1)[A11] = 0        x8 DQS/<math>\overline{DQS}</math>, <math>\overline{RDQS}</math>/<math>\overline{RDQS}</math>, if EMRS(1)[A11] = 1        x16 LDQS/<math>\overline{LDQS}</math> and UDQS/<math>\overline{UDQS}</math></p> <p>"single-ended DQS signals" refers to any of the following with A10 = 1 of EMRS(1)        x4 DQS        x8 DQS if EMRS(1)[A11] = 0        x8 DQS, RDQS, if EMRS(1)[A11] = 1        x16 LDQS and UDQS</p>



-Continue-

PIN	TYPE	DESCRIPTION
NC		No Connect : No internal electrical connection is present.
VDDQ	Supply	DQ Ground
VSSQ	Supply	DQ Power Supply : 1.8V +/- 0.1V
VDDL	Supply	DLL Power Supply : 1.8V +/- 0.1V
VSSDL	Supply	DLL Ground
VDD	Supply	Power Supply : 1.8V +/- 0.1V
VSS	Supply	Ground
VREF	Supply	Reference voltage for inputs for SSTL interface.

## 2. Maximum DC Ratings

### 2.1 Absolute Maximum DC Ratings

Symbol	Parameter	Rating	Units	Notes
VDD	Voltage on VDD pin relative to Vss	- 1.0 V ~ 2.3 V	V	1
VDDQ	Voltage on VDDQ pin relative to Vss	- 0.5 V ~ 2.3 V	V	1
VDDL	Voltage on VDDL pin relative to Vss	- 0.5 V ~ 2.3 V	V	1
V <sub>IN</sub> , V <sub>OUT</sub>	Voltage on any pin relative to Vss	- 0.5 V ~ 2.3 V	V	1
T <sub>STG</sub>	Storage Temperature	-55 to +100	°C	1, 2

- Stresses greater than those listed under "Absolute Maximum Ratings" may cause permanent damage to the device. This is a stress rating only and functional operation of the device at these or any other conditions above those indicated in the operational sections of this specification is not implied. Exposure to absolute maximum rating conditions for extended periods may affect reliability.
- Storage Temperature is the case surface temperature on the denter/top side of the DRAM. For the measurement conditions. Please refer to JESD51-2 standard.

### 2.2 Operating Temperature Condition

Symbol	Parameter	Rating	Units	Notes
Toper	Operating Temperature	0 to 85	°C	1,2

- Operating Temperature is the case surface temperature on the center/top side of the DRAM. For the measurement conditions, please refer to JESD51-2 standard.
- The operatin temperature range are the temperature where all DRAM specification will be supported. Outside of this temperature rang, even it is still within the limit of stress condition, some deviation on portion of operation specification may be required. During operation, the DRAM case temperature must be maintained between 0 ~ 85°C under all other specification parameters. However, in some applications, it is desirable to operate the DRAM up to 95°C case temperature. Therefore 2 spec options may exist.
  - Supporting 0 - 85°C with full JEDEC AC & DC specifications. This is the minimum requirements for all oprating temperature options.
  - Supporting 0 - 85°C and being able to extend to 95°C with doubling auto-refresh commands in frequency to a 32 ms period( $t_{RFI}=3.9\mu s$ ).

Note; Currently the periodic Self-Refresh interval is hard coded within the DRAM to a specificic value.

There is a migration plan to support higher temperature Self-Refresh entry via the control of EMRS(2) bit A7. However, since Self-Refresh control function is a migrated process. For our DDR2 module user, it is imperative to check SPD Byte 49 Bit 0 to ensure the DRAM parts support higher than 85°C case temperature Self-Refresh entry.

- if SPD Byte 49 Bit 0 is a "0" means DRAM does not support Self-Refresh at higher than 85°C, then system have to ensure the DRAM is at or below 85°C case temperature before initiating Self-Refresh operation.
- if SPD Byte 49 Bit 0 is a "1" means DRAM supports Self-Refresh at higher than 85°C case temperature, then system can use register bit A7 at EMRS(2) control DRAM to operate at proper Self-Refresh rate for higher temperature. Please also refer to EMRS(2) register definition section and DDR2 DIMM SPD definition for details.

### 3. AC & DC Operating Conditions

#### 3.1 DC Operating Conditions

##### 3.1.1 Recommended DC Operating Conditions (SSTL\_1.8)

Symbol	Parameter	Rating			Units	Notes
		Min.	Typ.	Max.		
VDD	Supply Voltage	1.7	1.8	1.9	V	
VDDL	Supply Voltage for DLL	1.7	1.8	1.9	V	4
VDDQ	Supply Voltage for Output	1.7	1.8	1.9	V	4
VREF	Input Reference Voltage	0.49*VDDQ	0.50*VDDQ	0.51*VDDQ	mV	1, 2
VTT	Termination Voltage	VREF-0.04	VREF	VREF+0.04	V	3

There is no specific device VDD supply voltage requirement for SSTL-1.8 compliance. However under all conditions VDDQ must be less than or equal to VDD.

1. The value of VREF may be selected by the user to provide optimum noise margin in the system. Typically the value of VREF is expected to be about 0.5 x VDDQ of the transmitting device and VREF is expected to track variations in VDDQ.
2. Peak to peak ac noise on VREF may not exceed +/-2% VREF (dc).
3. VTT of transmitting device must track VREF of receiving device.
4. VDDQ tracks with VDD, VDDL tracks with VDD. AC parameters are measured with VDD, VDDQ and VDDL tied together

##### 3.1.2 ODT DC electrical characteristics

PARAMETER/CONDITION	SYMBOL	MIN	NOM	MAX	UNITS	NOTES
Rtt effective impedance value for EMRS(A6,A2)=0,1; 75 ohm	Rtt1(eff)	60	75	90	ohm	1
Rtt effective impedance value for EMRS(A6,A2)=1,0; 150 ohm	Rtt2(eff)	120	150	180	ohm	1
Rtt effective impedance value for EMRS(A6,A2)=1,1; 550 ohm	Rtt2(eff)	40	50	60	ohm	1,2
Deviation of Vm with respect to VDDQ/2	delta VM	-6		+6	%	1

Note 1: Test condition for Rtt measurements

Note 2: Optional for DDR2-400/533/667

Measurement Definition for Rtt(eff): Apply  $V_{IH}(ac)$  and  $V_{IL}(ac)$  to test pin separately, then measure current  $I(V_{IH}(ac))$  and  $I(V_{IL}(ac))$  respectively.  $V_{IH}(ac)$ ,  $V_{IL}(ac)$ , and VDDQ values defined in SSTL\_18

$$R_{tt}(eff) = \frac{V_{IH}(ac) - V_{IL}(ac)}{I(V_{IH}(ac)) - I(V_{IL}(ac))}$$

Measurement Definition for VM : Measurement Voltage at test pin(mid point) with no load.

$$\text{delta VM} = \frac{2 \times V_m}{V_{DDQ}} - 1 \times 100\%$$

## 3.2 DC & AC Logic Input Levels

### 3.2.1 Input DC Logic Level

Symbol	Parameter	Min.	Max.	Units	Notes
$V_{IH}(dc)$	dc input logic high	$V_{REF} + 0.125$	$V_{DDQ} + 0.3$	V	
$V_{IL}(dc)$	dc input logic low	- 0.3	$V_{REF} - 0.125$	V	

### 3.2.2 Input AC Logic Level

Symbol	Parameter	Min.	Max.	Units	Notes
$V_{IH}(ac)$	ac input logic high	$V_{REF} + 0.250$	-	V	
$V_{IL}(ac)$	ac input logic low	-	$V_{REF} - 0.250$	V	

### 3.2.3 AC Input Test Conditions

Symbol	Condition	Value	Units	Notes
$V_{REF}$	Input reference voltage	$0.5 * V_{DDQ}$	V	1
$V_{SWING(MAX)}$	Input signal maximum peak to peak swing	1.0	V	1
SLEW	Input signal minimum slew rate	1.0	V/ns	2, 3

Notes:

- Input waveform timing is referenced to the input signal crossing through the  $V_{REF}$  level applied to the device under test.
- The input signal minimum slew rate is to be maintained over the range from  $V_{REF}$  to  $V_{IH(ac)}$  min for rising edges and the range from  $V_{REF}$  to  $V_{IL(ac)}$  max for falling edges as shown in the below figure.
- AC timings are referenced with input waveforms switching from  $V_{IL}(ac)$  to  $V_{IH}(ac)$  on the positive transitions and  $V_{IH}(ac)$  to  $V_{IL}(ac)$  on the negative transitions.

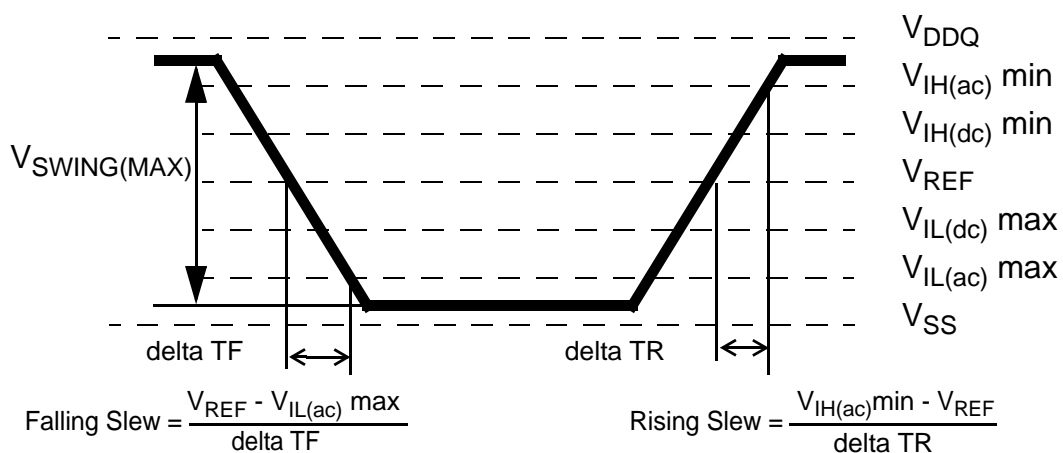

< Figure : AC Input Test Signal Waveform >

### 3.2.4 Differential Input AC logic Level

Symbol	Parameter	Min.	Max.	Units	Notes
$V_{ID(ac)}$	ac differential input voltage	0.5	$V_{DDQ} + 0.6$	V	1
$V_{IX(ac)}$	ac differential cross point voltage	$0.5 * V_{DDQ} - 0.175$	$0.5 * V_{DDQ} + 0.175$	V	2

- $V_{IN(DC)}$  specifies the allowable DC execution of each input of differential pair such as CK,  $\overline{CK}$ , DQS,  $\overline{DQS}$ , LDQS,  $\overline{LDQS}$ , UDQS and  $\overline{UDQS}$ .
- $V_{ID(DC)}$  specifies the input differential voltage  $|V_{TR} - V_{CP}|$  required for switching, where  $V_{TR}$  is the true input (such as CK, DQS, LDQS or UDQS) level and  $V_{CP}$  is the complementary input (such as  $\overline{CK}$ ,  $\overline{DQS}$ ,  $\overline{LDQS}$  or  $\overline{UDQS}$ ) level. The minimum value is equal to  $V_{IH(DC)} - V_{IL(DC)}$ .

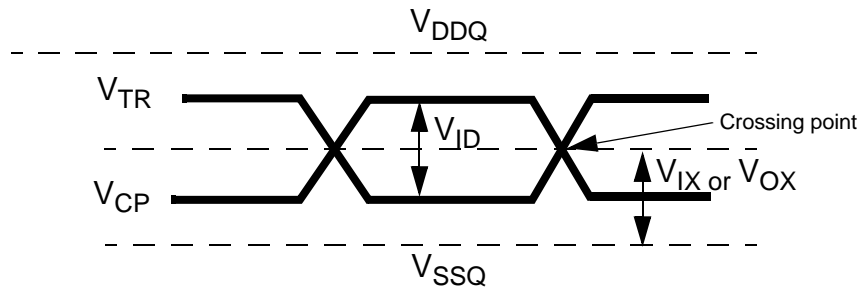

< Differential signal levels >

Notes:

- $V_{ID(AC)}$  specifies the input differential voltage  $|V_{TR} - V_{CP}|$  required for switching, where  $V_{TR}$  is the true input signal (such as CK, DQS, LDQS or UDQS) and  $V_{CP}$  is the complementary input signal (such as  $\overline{CK}$ ,  $\overline{DQS}$ ,  $\overline{LDQS}$  or  $\overline{UDQS}$ ). The minimum value is equal to  $V_{IH(AC)} - V_{IL(AC)}$ .
- The typical value of  $V_{IX(AC)}$  is expected to be about  $0.5 * V_{DDQ}$  of the transmitting device and  $V_{IX(AC)}$  is expected to track variations in  $V_{DDQ}$ .  $V_{IX(AC)}$  indicates the voltage at which differential input signals must cross.

### 3.2.5 Differential AC output parameters

Symbol	Parameter	Min.	Max.	Units	Notes
$V_{OX(ac)}$	ac differential cross point voltage	$0.5 * V_{DDQ} - 0.125$	$0.5 * V_{DDQ} + 0.125$	V	1

Notes:

- The typical value of  $V_{OX(AC)}$  is expected to be about  $0.5 * V_{DDQ}$  of the transmitting device and  $V_{OX(AC)}$  is expected to track variations in  $V_{DDQ}$ .  $V_{OX(AC)}$  indicates the voltage at which differential output signals must cross.

### 3.3 Output Buffer Characteristics

#### 3.3.1 Output AC Test Conditions

Symbol	Parameter	SSTL_18 Class II	Units	Notes
$V_{OTR}$	Output Timing Measurement Reference Level	$0.5 * V_{DDQ}$	V	1

1. The VDDQ of the device under test is referenced.

#### 3.3.2 Output DC Current Drive

Symbol	Parameter	SSTL_18	Units	Notes
$I_{OH(dc)}$	Output Minimum Source DC Current	- 13.4	mA	1, 3, 4
$I_{OL(dc)}$	Output Minimum Sink DC Current	13.4	mA	2, 3, 4

- $V_{DDQ} = 1.7\text{ V}$ ;  $V_{OUT} = 1420\text{ mV}$ .  $(V_{OUT} - V_{DDQ})/I_{OH}$  must be less than 21 ohm for values of  $V_{OUT}$  between  $V_{DDQ}$  and  $V_{DDQ} - 280\text{ mV}$ .
- $V_{DDQ} = 1.7\text{ V}$ ;  $V_{OUT} = 280\text{ mV}$ .  $V_{OUT}/I_{OL}$  must be less than 21 ohm for values of  $V_{OUT}$  between 0 V and 280 mV.
- The dc value of  $V_{REF}$  applied to the receiving device is set to  $V_{TT}$
- The values of  $I_{OH(dc)}$  and  $I_{OL(dc)}$  are based on the conditions given in Notes 1 and 2. They are used to test device drive current capability to ensure  $V_{IH\ min}$  plus a noise margin and  $V_{IL\ max}$  minus a noise margin are delivered to an SSTL\_18 receiver. The actual current values are derived by shifting the desired driver operating point (see Section 3.3) along a 21 ohm load line to define a convenient driver current for measurement.

#### 3.3.3 OCD default characteristics

Description	Parameter	Min	Nom	Max	Unit	Notes
Output impedance		12.6	18	23.4	ohms	1,2
Output impedance step size for OCD calibration		0		1.5	ohms	6
Pull-up and pull-down mismatch		0		4	ohms	1,2,3
Output slew rate	Sout	1.5	-	5	V/ns	1,4,5,6,7,8

Note 1: Absolute Specifications ( $0^{\circ}\text{C} \leq T_{CASE} \leq +tbd^{\circ}\text{C}$ ;  $V_{DD} = +1.8\text{V} \pm 0.1\text{V}$ ,  $V_{DDQ} = +1.8\text{V} \pm 0.1\text{V}$ )

Note 2: Impedance measurement condition for output source dc current:  $V_{DDQ} = 1.7\text{V}$ ;  $V_{OUT} = 1420\text{mV}$ ;  $(V_{OUT}-V_{DDQ})/I_{OH}$  must be less than 23.4 ohms for values of  $V_{OUT}$  between  $V_{DDQ}$  and  $V_{DDQ}-280\text{mV}$ .

Impedance measurement condition for output sink dc current:  $V_{DDQ} = 1.7\text{V}$ ;  $V_{OUT} = 280\text{mV}$ ;  $V_{OUT}/I_{OL}$  must be less than 23.4 ohms for values of  $V_{OUT}$  between 0V and 280mV.

Note 3: Mismatch is absolute value between pull-up and pull-dn, both are measured at same temperature and voltage.

Note 4: Slew rate measured from  $v_{il}(ac)$  to  $v_{ih}(ac)$ .

Note 5: The absolute value of the slew rate as measured from DC to DC is equal to or greater than the slew rate as measured from AC to AC. This is guaranteed by design and characterization.

Note 6: This represents the step size when the OCD is near 18 ohms at nominal conditions across all process corners/variations and represents only the DRAM uncertainty. A 0 ohm value(no calibration) can only be achieved if the OCD impedance is 18 ohms +/- 0.75 ohms under nominal conditions.

Output Slew rate load:

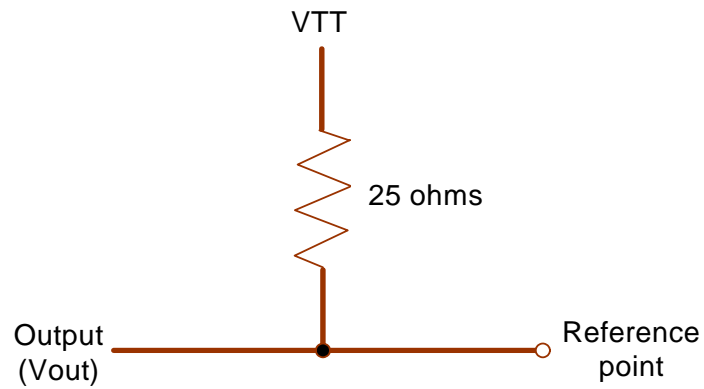

Note 7: DRAM output slew rate specification applies to 400MT/s & 533MT/s speed bins.

Note 8: Timing skew due to DRAM output slew rate mis-match between  $\overline{DQS}$  /  $\overline{DQS}$  and associated DQs is included in tDQSQ and tQHS specification.

### 3.4 IDD Specifications & Test Conditions

#### IDD Specifications(max)

Symbol		DDR2 400			DDR2 533			DDR2 667			Units
		x4	x8	x16	x4	x8	x16	x4	x8	x16	
IDD0		80	80	125	90	90	130	100	100	135	mA
IDD1		90	90	135	100	100	140	110	110	145	mA
IDD2P		6	6	6	7	7	7	8	8	8	mA
IDD2Q		35	35	35	40	40	40	50	50	50	mA
IDD2N		40	40	40	45	45	45	55	55	55	mA
IDD3P	F	20	20	20	25	25	25	30	30	30	mA
	s	5	5	5	6	6	6	7	7	7	mA
IDD3N		55	55	55	65	65	65	75	75	85	mA
IDD4W		150	150	180	180	180	220	230	230	270	mA
IDD4R		130	130	150	160	160	190	200	200	230	mA
IDD5		165	165	165	175	175	175	190	190	190	mA
IDD6	Normal	5.5	5.5	5.5	5.5	5.5	5.5	5.5	5.5	5.5	mA
	Low power	4	4	4	4	4	4	4	4	4	mA
IDD7		220	220	330	220	220	330	220	220	330	mA



## IDD Test Conditions

(IDD values are for full operating range of Voltage and Temperature, Notes 1-5)

Symbol	Conditions	Units	
IDD0	Operating one bank active-precharge current; $t_{CK} = t_{CK}(IDD)$ , $t_{RC} = t_{RC}(IDD)$ , $t_{RAS} = t_{RAS} \min(IDD)$ ; CKE is HIGH, $\overline{CS}$ is HIGH between valid commands; Address bus inputs are SWITCHING; Data bus inputs are SWITCHING	mA	
IDD1	Operating one bank active-read-precharge current; $I_{OUT} = 0mA$ ; $BL = 4$ , $CL = CL(IDD)$ , $AL = 0$ ; $t_{CK} = t_{CK}(IDD)$ , $t_{RC} = t_{RC}(IDD)$ , $t_{RAS} = t_{RAS} \min(IDD)$ , $t_{RCD} = t_{RCD}(IDD)$ ; CKE is HIGH, $\overline{CS}$ is HIGH between valid commands; Address bus inputs are SWITCHING; Data pattern is same as IDD4W	mA	
IDD2P	Precharge power-down current; All banks idle; $t_{CK} = t_{CK}(IDD)$ ; CKE is LOW; Other control and address bus inputs are STABLE; Data bus inputs are FLOATING	mA	
IDD2Q	Precharge quiet standby current; All banks idle; $t_{CK} = t_{CK}(IDD)$ ; CKE is HIGH, $\overline{CS}$ is HIGH; Other control and address bus inputs are STABLE; Data bus inputs are FLOATING	mA	
IDD2N	Precharge standby current; All banks idle; $t_{CK} = t_{CK}(IDD)$ ; CKE is HIGH, $\overline{CS}$ is HIGH; Other control and address bus inputs are SWITCHING; Data bus inputs are SWITCHING	mA	
IDD3P	Active power-down current; All banks open; $t_{CK} = t_{CK}(IDD)$ ; CKE is LOW; Other control and address bus inputs are STABLE; Data bus inputs are FLOATING	Fast PDN Exit MRS(12) = 0	mA
		Slow PDN Exit MRS(12) = 1	mA
IDD3N	Active standby current; All banks open; $t_{CK} = t_{CK}(IDD)$ , $t_{RAS} = t_{RAS} \max(IDD)$ , $t_{RP} = t_{RP}(IDD)$ ; CKE is HIGH, $\overline{CS}$ is HIGH between valid commands; Other control and address bus inputs are SWITCHING; Data bus inputs are SWITCHING	mA	
IDD4W	Operating burst write current; All banks open, Continuous burst writes; $BL = 4$ , $CL = CL(IDD)$ , $AL = 0$ ; $t_{CK} = t_{CK}(IDD)$ , $t_{RAS} = t_{RAS} \max(IDD)$ , $t_{RP} = t_{RP}(IDD)$ ; CKE is HIGH, $\overline{CS}$ is HIGH between valid commands; Address bus inputs are SWITCHING; Data bus inputs are SWITCHING	mA	
IDD4R	Operating burst read current; All banks open, Continuous burst reads, $I_{OUT} = 0mA$ ; $BL = 4$ , $CL = CL(IDD)$ , $AL = 0$ ; $t_{CK} = t_{CK}(IDD)$ , $t_{RAS} = t_{RAS} \max(IDD)$ , $t_{RP} = t_{RP}(IDD)$ ; CKE is HIGH, $\overline{CS}$ is HIGH between valid commands; Address bus inputs are SWITCHING; Data pattern is same as IDD4W	mA	
IDD5B	Burst refresh current; $t_{CK} = t_{CK}(IDD)$ ; Refresh command at every $t_{RFC}(IDD)$ interval; CKE is HIGH, $\overline{CS}$ is HIGH between valid commands; Other control and address bus inputs are SWITCHING; Data bus inputs are SWITCHING	mA	
IDD6	Self refresh current; $CK$ and $\overline{CK}$ at 0V; $CKE \leq 0.2V$ ; Other control and address bus inputs are FLOATING; Data bus inputs are FLOATING	mA	
IDD7	Operating bank interleave read current; All bank interleaving reads, $I_{OUT} = 0mA$ ; $BL = 4$ , $CL = CL(IDD)$ , $AL = t_{RCD}(IDD) - 1 * t_{CK}(IDD)$ ; $t_{CK} = t_{CK}(IDD)$ , $t_{RC} = t_{RC}(IDD)$ , $t_{RRD} = t_{RRD}(IDD)$ , $t_{RCD} = 1 * t_{CK}(IDD)$ ; CKE is HIGH, $\overline{CS}$ is HIGH between valid commands; Address bus inputs are STABLE during DESELECTs; Data pattern is same as IDD4R; - Refer to the following page for detailed timing conditions	mA	

### Note:

1. IDD specifications are tested after the device is properly initialized
2. Input slew rate is specified by AC Parametric Test Condition
3. IDD parameters are specified with ODT disabled.
4. Data bus consists of  $DQ$ ,  $DM$ ,  $DQS$ ,  $\overline{DQS}$ ,  $RDQS$ ,  $\overline{RDQS}$ ,  $LDQS$ ,  $\overline{LDQS}$ ,  $UDQS$ , and  $\overline{UDQS}$ . IDD values must be met with all combinations of EMRS bits 10 and 11.
5. Definitions for IDD
  - LOW is defined as  $V_{in} \leq V_{ILAC}(\max)$
  - HIGH is defined as  $V_{in} \geq V_{IHAC}(\min)$
  - STABLE is defined as inputs stable at a HIGH or LOW level
  - FLOATING is defined as inputs at  $V_{REF} = V_{DDQ}/2$
  - SWITCHING is defined as:
    - inputs changing between HIGH and LOW every other clock cycle (once per two clocks) for address and control signals, and
    - inputs changing between HIGH and LOW every other data transfer (once per clock) for DQ signals not including masks or strobes.

For purposes of IDD testing, the following parameters are to be utilized

	DDR2-667	DDR2-533	DDR2-400	
Parameter	5-5-5	4-4-4	3-3-3	Units
CL(IDD)	5	4	3	tCK
t <sub>RCD</sub> (IDD)	15	15	15	ns
t <sub>RC</sub> (IDD)	60	60	55	ns
t <sub>RRD</sub> (IDD)-x4/x8	7.5	7.5	7.5	ns
t <sub>RRD</sub> (IDD)-x16	9	10	10	ns
t <sub>CK</sub> (IDD)	3	3.75	5	ns
t <sub>RASmin</sub> (IDD)	45	45	40	ns
t <sub>RASmax</sub> (IDD)	70000	70000	70000	ns
t <sub>RP</sub> (IDD)	15	15	15	ns
t <sub>RFC</sub> (IDD)-256Mb	75	75	75	ns
t <sub>RFC</sub> (IDD)-512Mb	105	105	105	ns
t <sub>RFC</sub> (IDD)-1Gb	127.5	127.5	127.5	ns
t <sub>RFC</sub> (IDD)-2Gb	197.5	197.5	197.5	ns

#### Detailed IDD7

The detailed timings are shown below for IDD7. Changes will be required if timing parameter changes are made to the specification.  
 Legend: A = Active; RA = Read with Autoprecharge; D = Deselect

#### IDD7: Operating Current: All Bank Interleave Read operation

All banks are being interleaved at minimum t<sub>RC</sub>(IDD) without violating t<sub>RRD</sub>(IDD) using a burst length of 4. Control and address bus inputs are STABLE during DESELECTs. IOUT = 0mA

#### Timing Patterns for 4 bank devices x4/ x8/ x16

-DDR2-400 4/4/4: A0 RA0 A1 RA1 A2 RA2 A3 RA3 D D D D

-DDR2-400 3/3/3: A0 RA0 A1 RA1 A2 RA2 A3 RA3 D D D D

-DDR2-533 5/4/4: A0 RA0 D A1 RA1 D A2 RA2 D A3 RA3 D D D D

-DDR2-533 4/4/4: A0 RA0 D A1 RA1 D A2 RA2 D A3 RA3 D D D D

#### Timing Patterns for 8 bank devices x4/8

-DDR2-400 all bins: A0 RA0 A1 RA1 A2 RA2 A3 RA3 A4 RA4 A5 RA5 A6 RA6 A7 RA7

-DDR2-533 all bins: A0 RA0 A1 RA1 A2 RA2 A3 RA3 D D A4 RA4 A5 RA5 A6 RA6 A7 RA7 D D

#### Timing Patterns for 8 bank devices x16

-DDR2-400 all bins: A0 RA0 A1 RA1 A2 RA2 A3 RA3 D D A4 RA4 A5 RA5 A6 RA6 A7 RA7 D D

-DDR2-533 all bins: A0 RA0 D A1 RA1 D A2 RA2 D A3 RA3 D D D A4 RA4 D A5 D A6 RA6 D A7 RA7 D D D

### 3.5. Input/Output Capacitance

Parameter	Symbol	DDR2 400 DDR2 533		DDR2 667 DDR2 800		Units
		Min	Max	Min	Max	
Input capacitance, CK and $\overline{CK}$	CCK	1.0	2.0	1.0	2.0	pF
Input capacitance delta, CK and $\overline{CK}$	CDCK	x	0.25	x	0.25	pF
Input capacitance, all other input-only pins	CI	1.0	2.0	1.0	2.0	pF
Input capacitance delta, all other input-only pins	CDI	x	0.25	x	0.25	pF
Input/output capacitance, DQ, DM, DQS, $\overline{DQS}$	CIO	2.5	4.0	2.5	3.5	pF
Input/output capacitance delta, DQ, DM, DQS, $\overline{DQS}$	CDIO	x	0.5	x	0.5	pF

## 4. Electrical Characteristics & AC Timing Specification

( $0\text{ }^{\circ}\text{C} \leq T_{\text{CASE}} \leq 95\text{ }^{\circ}\text{C}$ ;  $V_{\text{DDQ}} = 1.8\text{ V} \pm 0.1\text{V}$ ;  $V_{\text{DD}} = 1.8\text{V} \pm 0.1\text{V}$ )

### Refresh Parameters by Device Density

Parameter	Symbol	256Mb	512Mb	1Gb	2Gb	4Gb	Units
Refresh to Active/Refresh command time	tRFC	75	105	127.5	195	327.5	ns
Average periodic refresh interval	tREFI	$0\text{ }^{\circ}\text{C} \leq T_{\text{CASE}} \leq 95\text{ }^{\circ}\text{C}$	7.8	7.8	7.8	7.8	ns
		$85\text{ }^{\circ}\text{C} < T_{\text{CASE}} \leq 95\text{ }^{\circ}\text{C}$	3.9	3.9	3.9	3.9	ns

### DDR2 SDRAM speed bins and tRCD, tRP and tRC for corresponding bin

Speed	DDR2-667	DDR2-533	DDR2-400	Units
Bin(CL-tRCD-tRP)	5-5-5	4-4-4	3-3-3	
Parameter	min	min	min	
CAS Latency	5	4	3	tCK
tRCD	15	15	15	ns
tRP <sup>Note1</sup>	15	15	15	ns
tRAS	45	45	40	ns
tRC	60	60	55	ns

Note 1: 8 bank device Precharge All Allowance : tRP for a Precharge All command for and 8 Bank device will equal to tRP+1\*tCK, where tRP are the values for a single bank precharge, which are shown in the above table.

## Timing Parameters by Speed Grade

Parameter	Symbol	DDR2-400		DDR2-533		Unit	Note
		min	max	min	max		
DQ output access time from $CK/\overline{CK}$	tAC	-600	+600	-500	+500	ps	
DQS output access time from $CK/\overline{CK}$	tDQSK	-500	+500	-450	+450	ps	
CK high-level width	tCH	0.45	0.55	0.45	0.55	tCK	
CK low-level width	tCL	0.45	0.55	0.45	0.55	tCK	
CK half period	tHP	min(tCL, tCH)	-	min(tCL, tCH)	-	ps	11,12
Clock cycle time, CL=x	tCK	5000	8000	3750	8000	ps	15
DQ and DM input setup time	tDS	150	-	100	-	ps	6,7,8,20
DQ and DM input hold time	tDH	275	-	225	-	ps	6,7,8,21
Control & Address input pulse width for each input	tIPW	0.6	-	0.6	-	tCK	
DQ and DM input pulse width for each input	tDIPW	0.35	-	0.35	-	tCK	
Data-out high-impedance time from $CK/\overline{CK}$	tHZ	-	tAC max	-	tAC max	ps	18
DQS low-impedance time from $CK/\overline{CK}$	tLZ(DQS)	tAC min	tAC max	tAC min	tAC max	ps	18
DQ low-impedance time from $CK/\overline{CK}$	tLZ(DQ)	2*tAC min	tAC max	2*tAC min	tAC max	ps	18
DQS-DQ skew for DQS and associated DQ signals	tDQSQ	-	350	-	300	ps	13
DQ hold skew factor	tQHS	-	450	-	400	ps	12
DQ/DQS output hold time from DQS	tQH	tHP - tQHS	-	tHP - tQHS	-	ps	
Write command to first DQS latching transition	tDOSS	WL - 0.25	WL + 0.25	WL - 0.25	WL + 0.25	tCK	
DQS input high pulse width	tDQSH	0.35	-	0.35	-	tCK	
DQS input low pulse width	tDQSL	0.35	-	0.35	-	tCK	
DQS falling edge to CK setup time	tDSS	0.2	-	0.2	-	tCK	
DQS falling edge hold time from CK	tDSH	0.2	-	0.2	-	tCK	
Mode register set command cycle time	tMRD	2	-	2	-	tCK	
Write postamble	tWPST	0.4	0.6	0.4	0.6	tCK	10
Write preamble	tWPRE	0.35	-	0.35	-	tCK	
Address and control input setup time	tIS	350	-	250	-	ps	5,7,9,23
Address and control input hold time	tIH	475	-	375	-	ps	5,7,9,23
Read preamble	tRPRE	0.9	1.1	0.9	1.1	tCK	
Read postamble	tRPST	0.4	0.6	0.4	0.6	tCK	
Active to active command period for 1KB page size products	tRRD	7.5	-	7.5	-	ns	4
Active to active command period for 2KB page size products	tRRD	10	-	10	-	ns	4
Four Active Window for 1KB page size products	tFAW	37.5	-	37.5	-	ns	

-Continued

Parameter	Symbol	DDR2-400		DDR2-533		Unit	Note
		min	max	min	max		
Four Active Window for 2KB page size products	tFAW	50	-	50	-		
$\overline{\text{CAS}}$ to $\overline{\text{CAS}}$ command delay	tCCD	2		2		tCK	
Write recovery time	tWR	15	-	15	-	ns	
Auto precharge write recovery + precharge time	tDAL	WR+tRP*	-	WR+tRP*	-	tCK	14
Internal write to read command delay	tWTR	10	-	7.5	-	ns	24
Internal read to precharge command delay	tRTP	7.5		7.5		ns	3
Exit self refresh to a non-read command	tXSNR	tRFC + 10		tRFC + 10		ns	
Exit self refresh to a read command	tXSRD	200	-	200	-	tCK	
Exit precharge power down to any non-read command	tXP	2	-	2	-	tCK	
Exit active power down to read command	tXARD	2		2		tCK	1
Exit active power down to read command (Slow exit, Lower power)	tXARDS	6 - AL		6 - AL		tCK	1, 2
CKE minimum pulse width (high and low pulse width)	t <sup>'</sup> CKE	3		3		tCK	
ODT turn-on delay	t <sup>'</sup> AOND	2	2	2	2	tCK	
ODT turn-on	t <sup>'</sup> AON	tAC(min)	tAC(max)+1	tAC(min)	tAC(max)+ <sub>1</sub>	ns	16
ODT turn-on(Power-Down mode)	t <sup>'</sup> AONPD	tAC(min)+2	2tCK+tAC(max)+1	tAC(min)+2	2tCK+tAC(max)+ <sub>1</sub>	ns	
ODT turn-off delay	t <sup>'</sup> AOFD	2.5	2.5	2.5	2.5	tCK	
ODT turn-off	t <sup>'</sup> AOF	tAC(min)	tAC(max)+0.6	tAC(min)	tAC(max)+0.6	ns	17
ODT turn-off (Power-Down mode)	t <sup>'</sup> AOFPD	tAC(min)+2	2.5tCK+tAC(max)+1	tAC(min)+2	2.5tCK+tAC(max)+1	ns	
ODT to power down entry latency	tANPD	3		3		tCK	
ODT power down exit latency	tAXPD	8		8		tCK	
OCD drive mode output delay	tOIT	0	12	0	12	ns	
Minimum time clocks remains ON after CKE asynchronously drops LOW	tDelay	tIS+tCK+tIH		tIS+tCK+tIH		ns	15

Parameter	Symbol	DDR2-667		Unit	Note
		min	max		
DQ output access time from CK/ $\overline{\text{CK}}$	tAC	-450	+450	ps	
DQS output access time from CK/ $\overline{\text{CK}}$	tDQSCK	-400	+400	ps	
CK high-level width	tCH	0.45	0.55	tCK	
CK low-level width	tCL	0.45	0.55	tCK	
CK half period	tHP	min(tCL, tCH)	-	ps	11,12
Clock cycle time, CL=x	tCK	3000	8000	ps	15
DQ and DM input setup time	tDS	50	-	ps	6,7,8,20
DQ and DM input hold time	tDH	175	-	ps	6,7,8,21
Control & Address input pulse width for each input	tIPW	0.6	-	tCK	
DQ and DM input pulse width for each input	tDIPW	0.35	-	tCK	
Data-out high-impedance time from CK/ $\overline{\text{CK}}$	tHZ	-	tAC max	ps	18
DQS low-impedance time from CK/ $\overline{\text{CK}}$	tLZ (DQS)	tAC min	tAC max	ps	18
DQ low-impedance time from CK/ $\overline{\text{CK}}$	tLZ (DQ)	2*tAC min	tAC max	ps	18
DQS-DQ skew for DQS and associated DQ signals	tDQSQ	-	240	ps	13
DQ hold skew factor	tQHS	-	340	ps	12
DQ/DQS output hold time from DQS	tQH	tHP - tQHS	-	ps	
Write command to first DQS latching transition	tDQSS	WL - 0.25	WL + 0.25	tCK	
DQS input high pulse width	tDQSH	0.35	-	tCK	
DQS input low pulse width	tDQSL	0.35	-	tCK	
DQS falling edge to CK setup time	tDSS	0.2	-	tCK	
DQS falling edge hold time from CK	tDSH	0.2	-	tCK	
Mode register set command cycle time	tMRD	2	-	tCK	
Write postamble	tWPST	0.4	0.6	tCK	10
Write preamble	tWPRE	0.35	-	tCK	
Address and control input setup time	tIS	150	-	ps	5,7,9,22
Address and control input hold time	tIH	275	-	ps	5,7,9,23
Read preamble	tRPRE	0.9	1.1	tCK	19
Read postamble	tRPST	0.4	0.6	tCK	19
Activate to precharge command	tRAS	45	70000	ns	3
Active to active command period for 1KB page size products	tRRD	7.5	-	ns	4
Active to active command period for 2KB page size products	tRRD	10	-	ns	4
Four Active Window for 1KB page size products	tFAW	37.5	-	ns	

-Continued

Parameter	Symbol	DDR2-667		Unit	Note
		min	max		
Four Active Window for 1KB page size products	tFAW	37.5	-	ns	
Four Active Window for 2KB page size products	tFAW	50	-	ns	
$\overline{\text{CAS}}$ to $\overline{\text{CAS}}$ command delay	tCCD	2		tCK	
Write recovery time	tWR	15	-	ns	
Auto precharge write recovery + precharge time	tDAL	WR+tRP	-	tCK	14
Internal write to read command delay	tWTR	7.5	-	ns	
Internal read to precharge command delay	tRTP	7.5		ns	3
Exit self refresh to a non-read command	tXSNR	tRFC + 10		ns	
Exit self refresh to a read command	tXSRD	200	-	tCK	
Exit precharge power down to any non-read command	tXP	2	-	tCK	
Exit active power down to read command	tXARD	2		tCK	1
Exit active power down to read command (Slow exit, Lower power)	tXARDS	6 - AL		tCK	1, 2
CKE minimum pulse width (high and low pulse width)	t <sup>o</sup> CKE	3		tCK	
ODT turn-on delay	t <sup>o</sup> AOND	2	2	tCK	
ODT turn-on	t <sup>o</sup> AON	tAC(min)	tAC(max)+0.7	ns	6,16
ODT turn-on(Power-Down mode)	t <sup>o</sup> AONPD	tAC(min)+2	2tCK+tAC(max)+1	ns	
ODT turn-off delay	t <sup>o</sup> AOFD	2.5	2.5	tCK	
ODT turn-off	t <sup>o</sup> AOF	tAC(min)	tAC(max)+ 0.6	ns	17
ODT turn-off (Power-Down mode)	t <sup>o</sup> AOFPD	tAC(min)+2	2.5tCK+tAC(max)+1	ns	
ODT to power down entry latency	tANPD	3		tCK	
ODT power down exit latency	tAXPD	8		tCK	
OCD drive mode output delay	tOIT	0	12	ns	
Minimum time clocks remains ON after CKE asynchronously drops LOW	tDelay	tIS+tCK+tIH		ns	15

## General notes, which may apply for all AC parameters

### 1. Slew Rate Measurement Levels

- Output slew rate for falling and rising edges is measured between  $V_{TT} - 250\text{ mV}$  and  $V_{TT} + 250\text{ mV}$  for single ended signals. For differential signals (e.g.  $DQS - \overline{DQS}$ ) output slew rate is measured between  $DQS - \overline{DQS} = -500\text{ mV}$  and  $DQS - \overline{DQS} = +500\text{ mV}$ . Output slew rate is guaranteed by design, but is not necessarily tested on each device.
- Input slew rate for single ended signals is measured from dc-level to ac-level: from  $V_{REF} - 125\text{ mV}$  to  $V_{REF} + 250\text{ mV}$  for rising edges and from  $V_{REF} + 125\text{ mV}$  and  $V_{REF} - 250\text{ mV}$  for falling edges. For differential signals (e.g.  $CK - \overline{CK}$ ) slew rate for rising edges is measured from  $CK - \overline{CK} = -250\text{ mV}$  to  $CK - \overline{CK} = +500\text{ mV}$  (250mV to -500 mV for falling edges).
- VID is the magnitude of the difference between the input voltage on  $CK$  and the input voltage on  $\overline{CK}$ , or between  $DQS$  and  $\overline{DQS}$  for differential strobe.

### 2. DDR2 SDRAM AC timing reference load

The following figure represents the timing reference load used in defining the relevant timing parameters of the part. It is not intended to be either a precise representation of the typical system environment nor a depiction of the actual load presented by a production tester. System designers will use IBIS or other simulation tools to correlate the timing reference load to a system environment. Manufacturers will correlate to their production test conditions (generally a coaxial transmission line terminated at the tester electronics).

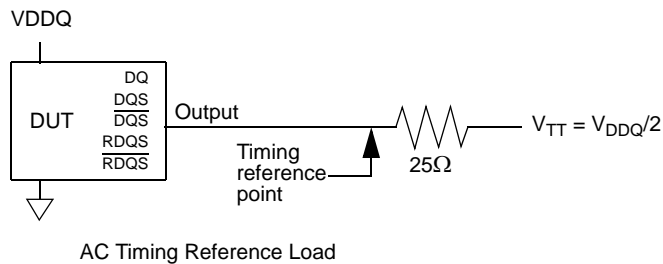

The output timing reference voltage level for single ended signals is the crosspoint with  $V_{TT}$ . The output timing reference voltage level for differential signals is the crosspoint of the true (e.g.  $DQS$ ) and the complement (e.g.  $\overline{DQS}$ ) signal.

### 3. DDR2 SDRAM output slew rate test load

Output slew rate is characterized under the test conditions as shown below.

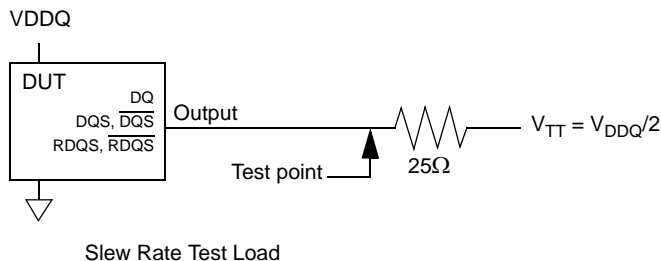

### 4. Differential data strobe

DDR2 SDRAM pin timings are specified for either single ended mode or differential mode depending on the setting of the EMRS "Enable DQS" mode bit; timing advantages of differential mode are realized in system design. The method by which the DDR2 SDRAM pin timings are measured is mode dependent. In single



VREF. In differential mode, these timing relationships are measured relative to the crosspoint of DQS and its complement,  $\overline{DQS}$ . This distinction in timing methods is guaranteed by design and characterization. Note that when differential data strobe mode is disabled via the EMRS, the complementary pin,  $\overline{DQS}$ , must be tied externally to VSS through a 20 ohm to 10 K ohm resistor to insure proper operation.

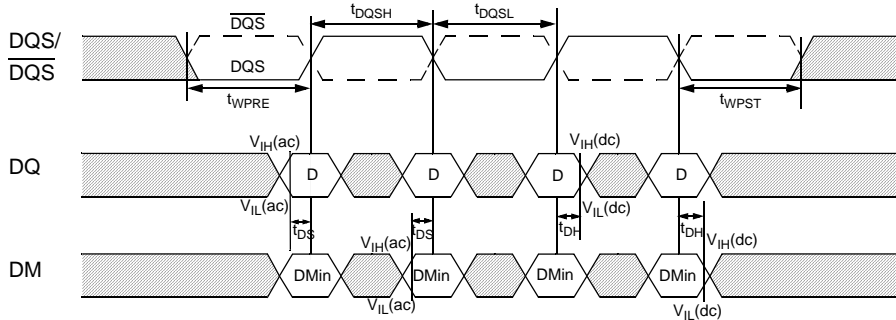

Figure -- Data input (write) timing

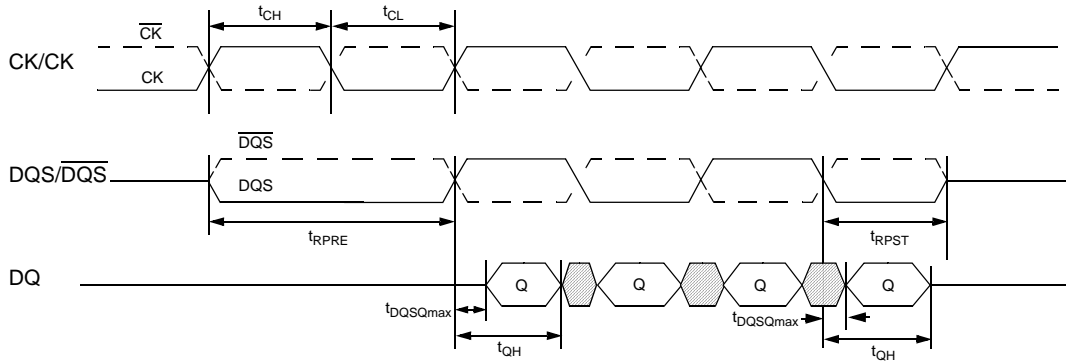

Figure -- Data output (read) timing

5. AC timings are for linear signal transitions. See System Derating for other signal transitions.
6. These parameters guarantee device behavior, but they are not necessarily tested on each device. They may be guaranteed by device design or tester correlation.
7. All voltages referenced to VSS.
8. Tests for AC timing, IDD, and electrical (AC and DC) characteristics, may be conducted at nominal reference/supply voltage levels, but the related specifications and device operation are guaranteed for the full voltage range specified.

## Specific Notes for dedicated AC parameters

1. User can choose which active power down exit timing to use via MRS(bit 12). tXARD is expected to be used for fast active power down exit timing. tXARDS is expected to be used for slow active power down exit timing where a lower power value is defined by each vendor data sheet.
2. AL = Additive Latency
3. This is a minimum requirement. Minimum read to precharge timing is AL + BL/2 providing the tRTP and tRAS(min) have been satisfied.
4. A minimum of two clocks (2 \* tCK) is required irrespective of operating frequency
5. Timings are guaranteed with command/address input slew rate of 1.0 V/ns. See System Derating for other slew rate values.
6. Timings are guaranteed with data, mask, and (DQS/RDQS in singled ended mode) input slew rate of 1.0 V/ns. See System Derating for other slew rate values.
7. Timings are guaranteed with CK/ $\overline{\text{CK}}$  differential slew rate of 2.0 V/ns. Timings are guaranteed for DQS signals with a differential slew rate of 2.0 V/ns in differential strobe mode and a slew rate of 1V/ns in single ended mode. See System Derating for other slew rate values.
8. tDS and tDH derating

tDS, tDH Derating Values(ALL units in 'ps', Note 1 applies to entire Table)																			
		DQS, DQS Differential Slew Rate																	
		4.0 V/ns		3.0 V/ns		2.0 V/ns		1.8 V/ns		1.6 V/ns		1.4 V/ns		1.2 V/ns		1.0 V/ns		0.8 V/ns	
		$\Delta tD$ S	$\Delta tD$ H	$\Delta tD$ S	$\Delta tD$ H	$\Delta tD$ S	$\Delta tD$ H	$\Delta tD$ S	$\Delta tD$ H	$\Delta tD$ S	$\Delta tD$ H	$\Delta tD$ S	$\Delta tD$ H	$\Delta tD$ S	$\Delta tD$ H	$\Delta tD$ S	$\Delta tD$ H	$\Delta tD$ S	$\Delta tD$ H
DQ Slew rate V/ns	2.0	125	45	125	45	+125	+45	-	-	-	-	-	-	-	-	-	-	-	-
	1.5	83	21	83	21	+83	+21	95	33	-	-	-	-	-	-	-	-	-	-
	1.0	0	0	0	0	0	0	12	12	24	24	-	-	-	-	-	-	-	-
	0.9	-	-	-11	-14	-11	-14	1	-2	13	10	25	22	-	-	-	-	-	-
	0.8	-	-	-	-	-25	-31	-13	-19	-1	-7	11	5	23	17	-	-	-	-
	0.7	-	-	-	-	-43	-54	-31	-42	-42	-19	-7	-8	5	-6	17	6	-	-
	0.6	-	-	-	-	-67	-83	-	-	-43	-59	-31	-47	-19	-35	-7	-23	5	-11
	0.5	-	-	-	-	-110	-125	-	-	-	-	-74	-89	-62	-77	-50	-65	-38	-53
	0.4	-	-	-	-	-175	-188	-	-	-	-	-	-	-127	-140	-115	-128	-103	-116

1) For all input signals the total tDS(setup time) and tDH(hold time) required is calculated by adding the datasheet value to the derating value listed in Table x.

Setup(tDS) nominal slew rate for a rising signal is defined as the slew rate between the last crossing of VREF(dc) and the first crossing of Vih(ac)min. Setup(tDS) nominal slew rate for a falling signal is defined as the slew rate between the last crossing of VREF(dc) and the first crossing of Vil(ac)max. If the actual signal is always earlier than the nominal slew rate line between shaded 'VREF(dc) to ac region', use nominal slew rate for derating value(see Fig a.) If the actual signal is later than the nominal slew rate line anywhere between shaded 'VREF(dc) to ac region', the slew rate of a tangent line to the actual signal from the ac level to dc level is used for derating value(see Fig b.)

Hold(tDH) nominal slew rate for a rising signal is defined as the slew rate rate between the last crossing of Vil(dc) max and the first crossing of VREF(dc). Hold (tDH) nominal slew rate for a falling signal is defined as the slew rate between the last crossing of Vih(dc) min and the first crossing of VREF(dc). If the actual signal is earlier than the nominal slew rate line anywhere between shaded 'dc to VREF(dc) region', the slew rate of a tangent line to the actual signal from the dc level to VREF(dc) level is used for derating value(see

Fig d.)

Although for slow slew rates the total setup time might be negative(i.e. a valid input signal will not have reached VIH/IL(ac) at the time of the rising clock transition) a valid input signal is still required to complete the transition and reach VIH/IL(ac). For slew rate in between the values listed in table x, the derating valued may obtained by linear interpolation. These values are typically not subject to production test. They are verified by design and characterization.

**Fig. a Illustration of nominal slew rate for tIS,tDS**

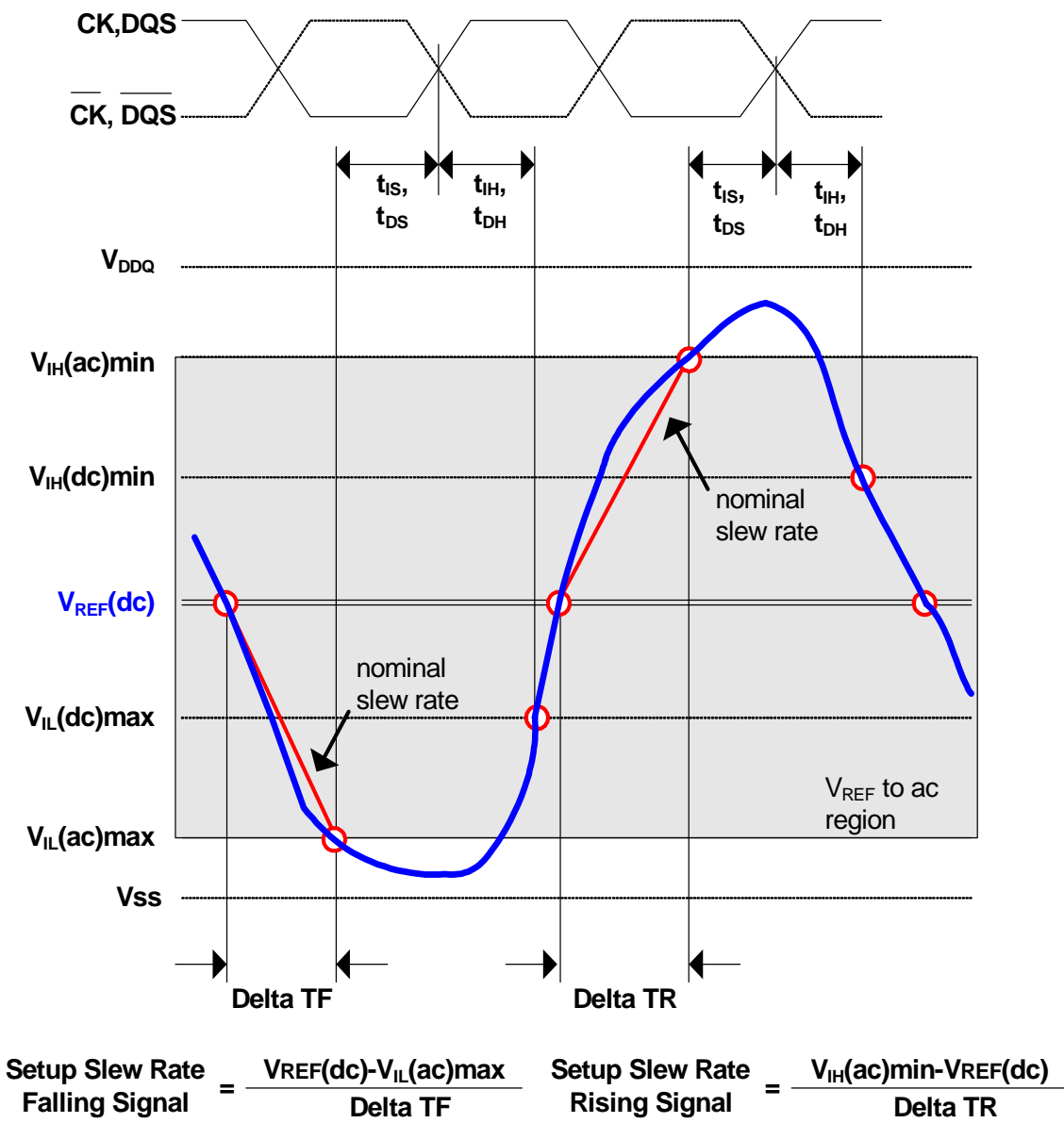

Fig. -b Illustration of tangent line for tIS,tDS

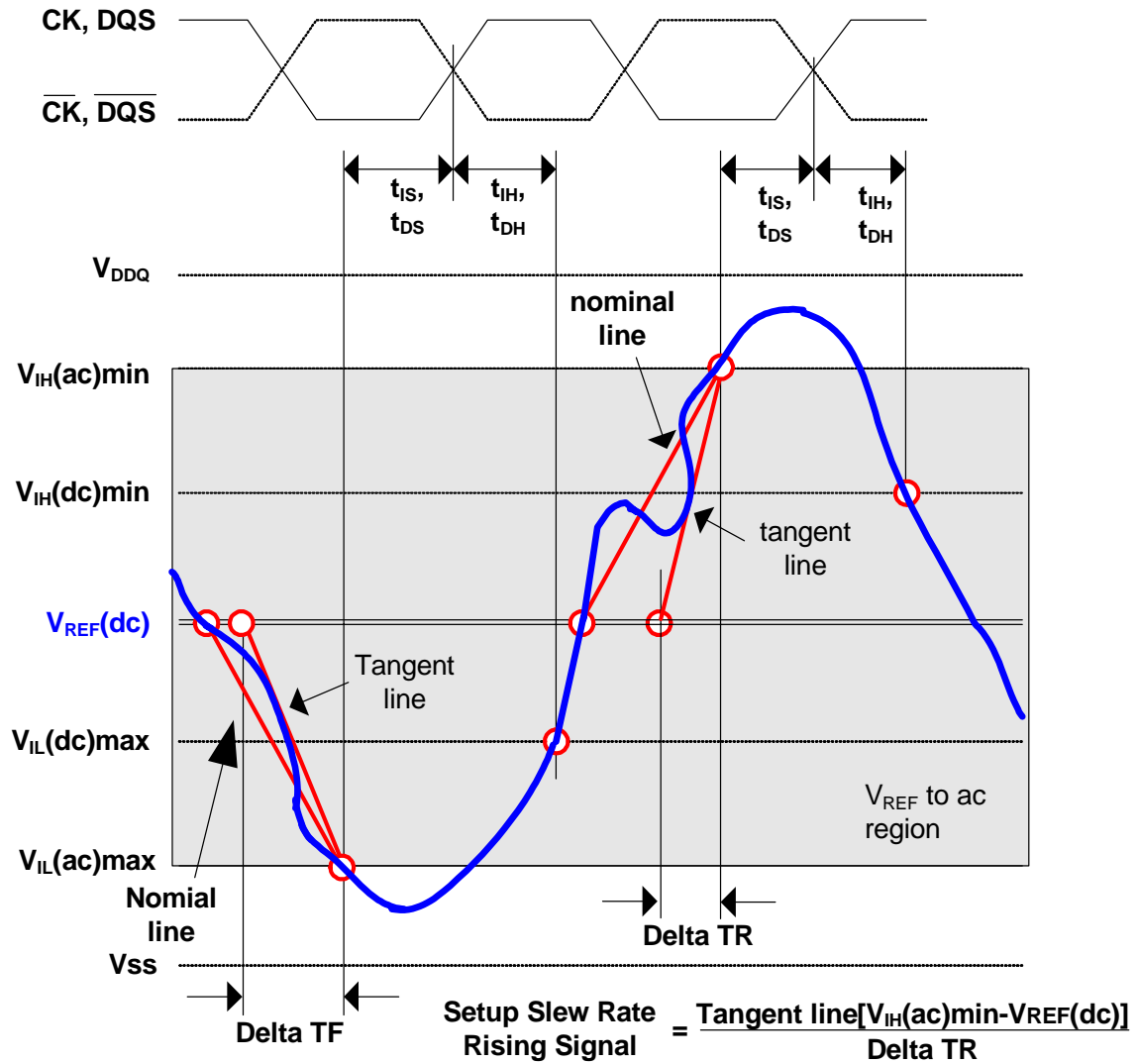

Fig. -c Illustration of nominal line for tIH, tDH

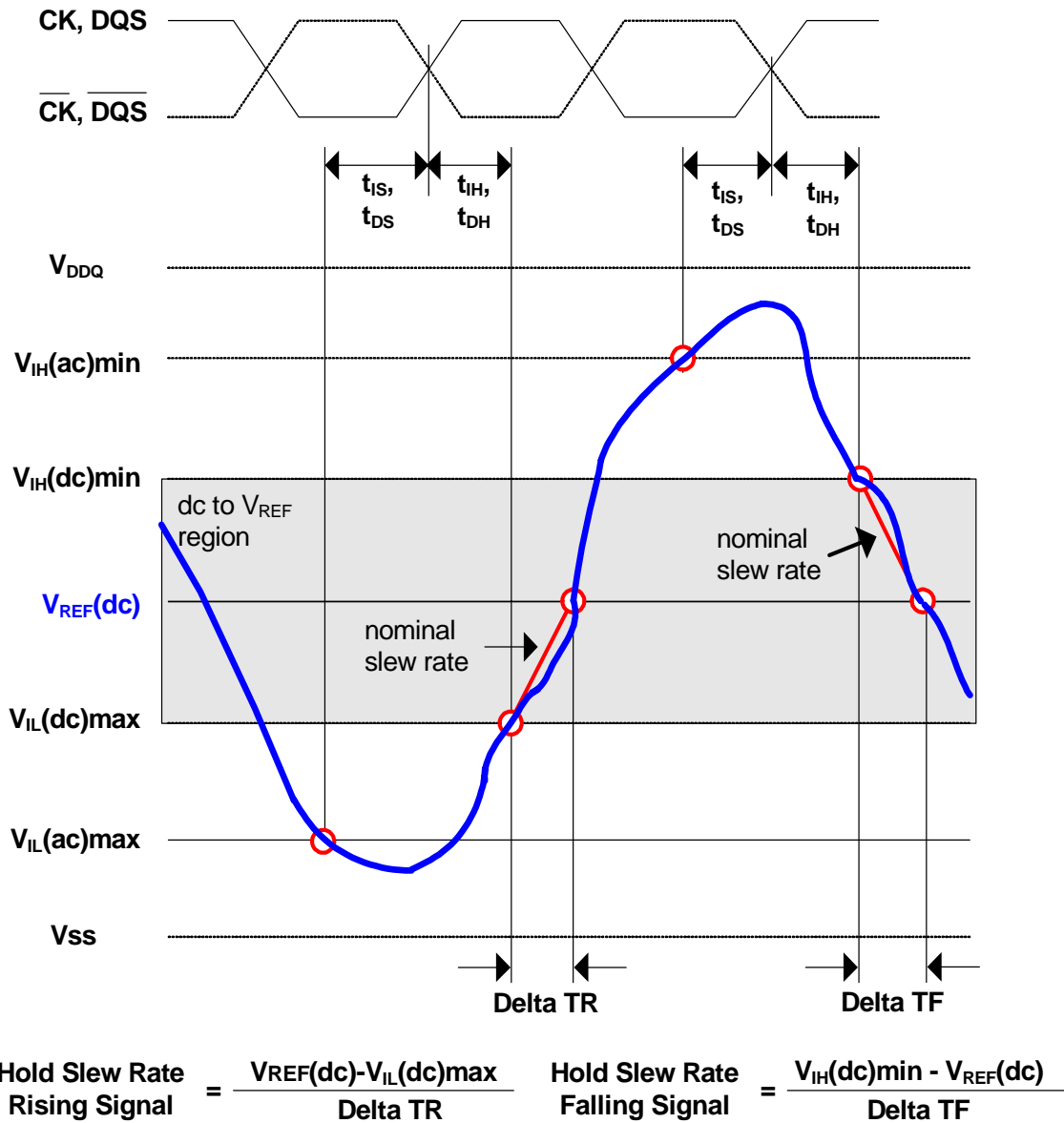
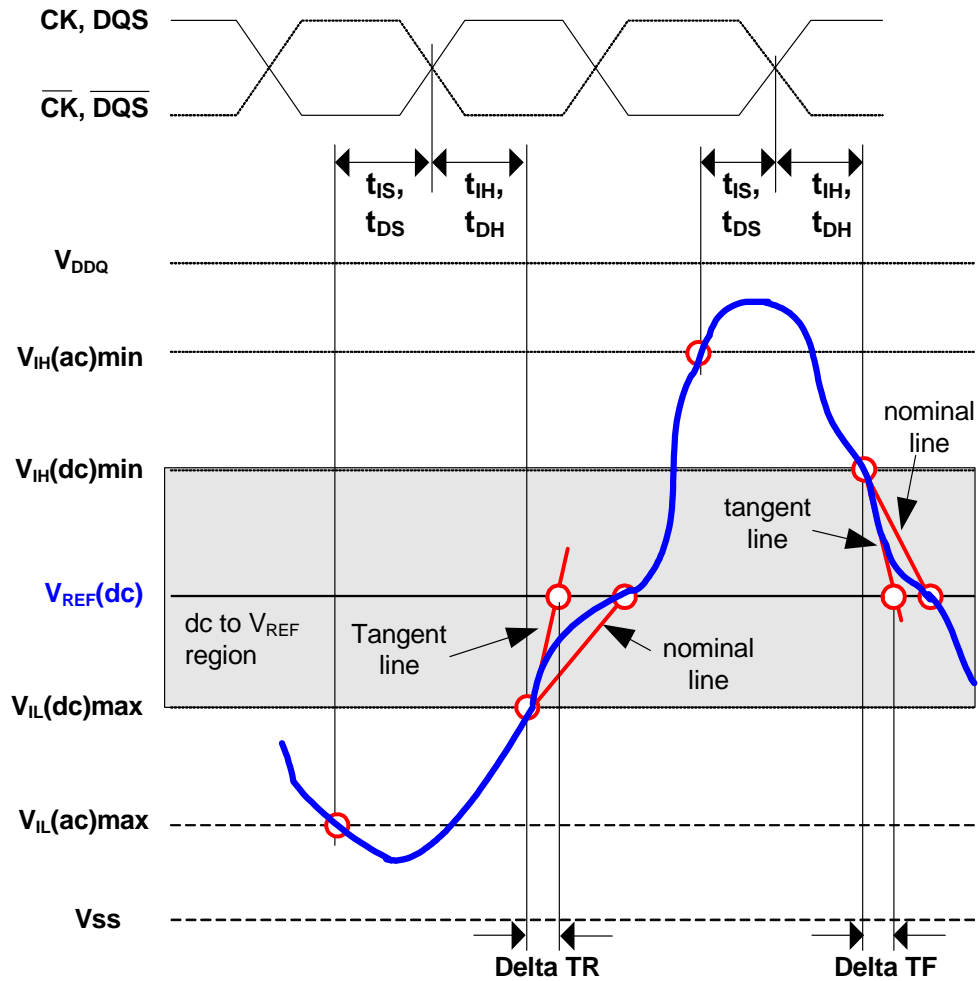

Fig. -d Illustration of tangent line for tIH , tDH



$$\text{Hold Slew Rate Rising Signal} = \frac{\text{Tangent line}[V_{REF}(dc) - V_{IL}(ac)max]}{\text{Delta TR}}$$

$$\text{Hold Slew Rate Falling Signal} = \frac{\text{Tangent line}[V_{IH}(ac)min - V_{REF}(dc)]}{\text{Delta TF}}$$

9. tIS and tIH (input setup and hold) derating

tIS, tIH Derating Values											
		CK, CK Differential Slew Rate						Units		Notes	
		2.0 V/ns		1.5 V/ns		1.0 V/ns					
		$\Delta tIS$	$\Delta tIH$	$\Delta tIS$	$\Delta tIH$	$\Delta tIS$	$\Delta tIH$				
Command / Address Slew rate(V/ns)	4.0	+187	+94	TBD	TBD	TBD	TBD	ps	1		
	3.5	+179	+89	TBD	TBD	TBD	TBD	ps	1		
	3.0	+167	+83	TBD	TBD	TBD	TBD	ps	1		
	2.5	+150	+75	TBD	TBD	TBD	TBD	ps	1		
	2.0	+125	+45	TBD	TBD	TBD	TBD	ps	1		
	1.5	+83	+21	TBD	TBD	TBD	TBD	ps	1		
	1.0	+0	0	TBD	TBD	TBD	TBD	ps	1		
	0.9	-11	-14	TBD	TBD	TBD	TBD	ps	1		
	0.8	-25	-31	TBD	TBD	TBD	TBD	ps	1		
	0.7	-43	-54	TBD	TBD	TBD	TBD	ps	1		
	0.6	-67	-83	TBD	TBD	TBD	TBD	ps	1		
	0.5	-100	-125	TBD	TBD	TBD	TBD	ps	1		
	0.4	-150	-188	TBD	TBD	TBD	TBD	ps	1		
	0.3	-223	-292	TBD	TBD	TBD	TBD	ps	1		
	0.25	-250	-375	TBD	TBD	TBD	TBD	ps	1		
	0.2	-500	-500	TBD	TBD	TBD	TBD	ps	1		
0.15	-750	-708	TBD	TBD	TBD	TBD	ps	1			
0.1	-1250	-1125	TBD	TBD	TBD	TBD	ps	1			

1) For all input signals the total tIS(setup time) and tIH(hold) time) required is calculated by adding the datasheet value to the derating value listed in above Table.

Setup(tIS) nominal slew rate for a rising signal is defined as the slew rate between the last crossing of  $V_{REF}(dc)$  and the first crossing of  $V_{IH}(ac)min$ . Setup(tIS) nominal slew rate for a falling signal is defined as the slew rate between the last crossing of  $V_{REF}(dc)$  and the first crossing of  $V_{IL}(ac)max$ . If the actual signal is always earlier than the nominal slew rate for line between shaded ' $V_{REF}(dc)$  to ac region', use nominal slew rate for derating value(see fig a.) If the actual signal is later than the nominal slew rate line anywhere between shaded ' $V_{REF}(dc)$  to ac region', the slew rate of a tangent line to the actual signal from the ac level to dc level is used for derating value(see Fig b.)

Hold(tIH) nominal slew rate for a rising signal is defined as the slew rate between the last crossing of  $V_{IL}(dc)max$  and the first crossing of  $V_{REF}(dc)$ . Hold(tIH) nominal slew rate for a falling signal is defined as the slew rate between the last crossing of  $V_{REF}(dc)$ . If the actual signal signal is always later than the nominal slew rate line between shaded ' $dc$  to  $V_{REF}(dc)$  region', use nominal slew rate for derating value(see Fig.c) If the actual signal is earlier than the nominal slew rate line anywhere between shaded ' $dc$  to  $V_{REF}(dc)$  region', the slew rate of a tangent line to the actual signal from the dc level to  $V_{REF}(dc)$  level is used for derating value(see Fig d.)

Although for slow rates the total setup time might be negative(i.e. a valid input signal will not have reached  $V_{IH/IL}(ac)$  at the time of the rising clock transition) a valid input signal is still required to complete the transition and reach  $V_{IH/IL}(ac)$ .

For slew rates in between the values listed in table, the derating values may obtained by linear interpolation.

These values are typically not subject to production test. They are verified by design and characterization.

10. The maximum limit for this parameter is not a device limit. The device will operate with a greater value for this parameter, but system performance (bus turnaround) will degrade accordingly.

11. MIN ( t CL, t CH) refers to the smaller of the actual clock low time and the actual clock high time as provided to the device (i.e. this value can be greater than the minimum specification limits for t CL and t CH). For example, t CL and t CH are = 50% of the period, less the half period jitter ( t JIT(HP)) of the clock source, and less the half period jitter due to crosstalk ( t JIT(crosstalk)) into the clock traces.

12. t QH = t HP – t QHS, where:

tHP = minimum half clock period for any given cycle and is defined by clock high or clock low ( tCH, tCL).

tQHS accounts for:

1) The pulse duration distortion of on-chip clock circuits; and

2) The worst case push-out of DQS on one transition followed by the worst case pull-in of DQ on the next transition, both of which are, separately, due to data pin skew and output pattern effects, and p-channel to n-channel variation of the output drivers.

13. tDQSQ: Consists of data pin skew and output pattern effects, and p-channel to n-channel variation of the output drivers as well as output slew rate mismatch between DQS/  $\overline{DQS}$  and associated DQ in any given cycle.

14. t DAL = (nWR) + ( tRP/tCK):

For each of the terms above, if not already an integer, round to the next highest integer. tCK refers to the application clock period. nWR refers to the t WR parameter stored in the MRS.

Example: For DDR533 at t CK = 3.75 ns with t WR programmed to 4 clocks. tDAL = 4 + (15 ns / 3.75 ns) clocks = 4 + (4)clocks=8clocks.

15. The clock frequency is allowed to change during self-refresh mode or precharge power-down mode. In case of clock frequency change during precharge power-down, a specific procedure is required as described in section 2.9.

16. ODT turn on time min is when the device leaves high impedance and ODT resistance begins to turn on.

ODT turn on time max is when the ODT resistance is fully on. Both are measured from tAOND.

17. ODT turn off time min is when the device starts to turn off ODT resistance.

ODT turn off time max is when the bus is in high impedance. Both are measured from tAOFD.

18. tHZ and tLZ transitions occur in the same access time as valid data transitions. These parameters are referenced to a specific voltage level which specifies when the device output is no longer driving (tHZ), or begins driving (tLZ). Below figure shows a method to calculate the point when device is no longer driving (tHZ), or begins driving (tLZ) by measuring the signal at two different voltages. The actual voltage measurement points are not critical as long as the calculation is consistent.

19. tRPST end point and tRPRE begin point are not referenced to a specific voltage level but specify when the device output is no longer driving (tRPST), or begins driving (tRPRE). Below figure shows a method to calculate these points when the device is no longer driving (tRPST), or begins driving (tRPRE). Below Figure shows a method to calculate different voltages. The actual voltage measurement points are not critical as long as the calculation is consistent.



these points when the device is no longer driving (tRPST), or begins driving (tRPRE) by measuring the signal at two

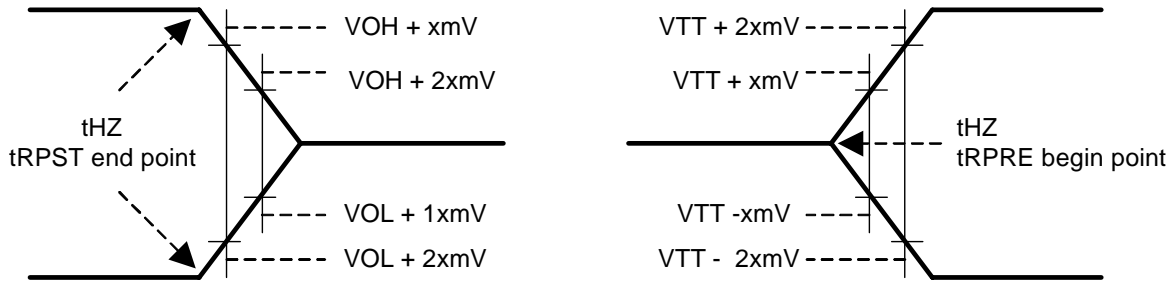

$t_{HZ}$  , tRPST end point =  $2 \cdot T_1 - T_2$

$t_{LZ}$  , tRPRE begin point =  $2 \cdot T_1 - T_2$

20. Input waveform timing with differential data strobe enabled MR[bit10]=0, is referenced from the input signal crossing at the  $V_{IH}(ac)$  level to the differential data strobe crosspoint for a rising signal, and from the input signal crossing at the  $V_{IL}(ac)$  level to the differential data strobe crosspoint for a falling signal applied to the device under test.

21. Input waveform timing with differential data strobe enabled MR[bit10]=0, is referenced from the input signal crossing at the  $V_{IH}(dc)$  level to the differential data strobe crosspoint for a rising signal and  $V_{IL}(dc)$  to the differential data strobe crosspoint for a falling signal applied to the device under test.

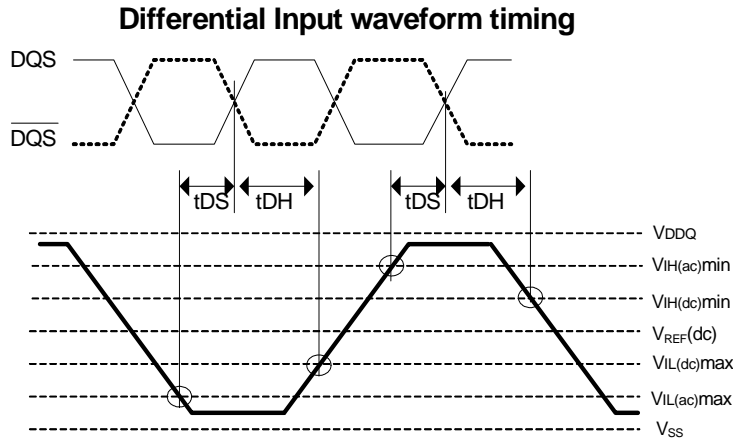

22. Input waveform timing is referenced from the input signal crossing at the  $V_{IH}(ac)$  level for a rising signal and  $V_{IL}(ac)$  for a falling signal applied to the device under test.

23. Input waveform timing is referenced from the input signal crossing at the  $V_{IL}(dc)$  level for a rising signal and  $V_{IH}(dc)$  for a falling signal applied to the device under test.

## 5. PACKAGE DIMENSIONS

### Package Dimension(x4/x8)

#### 60Ball Fine Pitch Ball Grid Array Outline

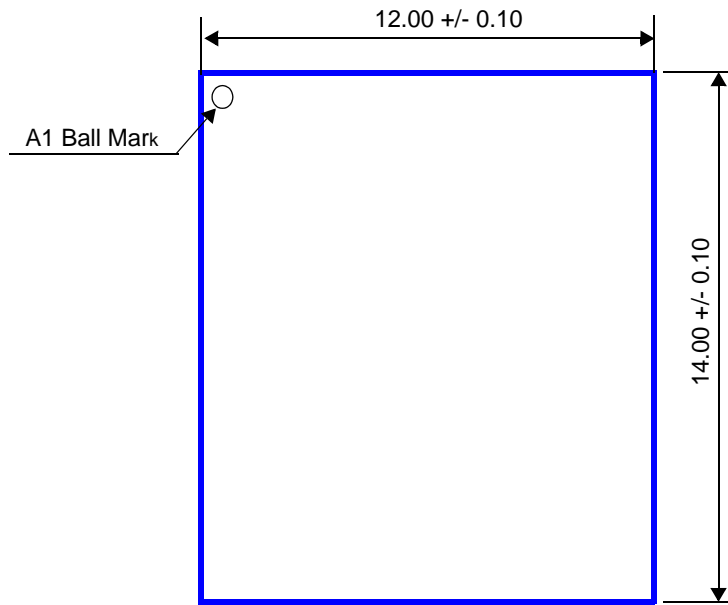

<Top View>

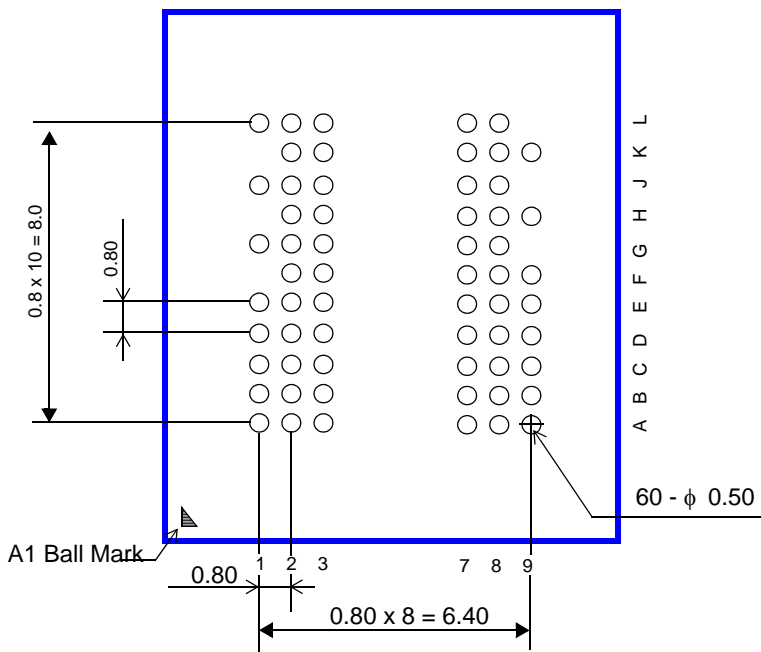

<Bottom View>

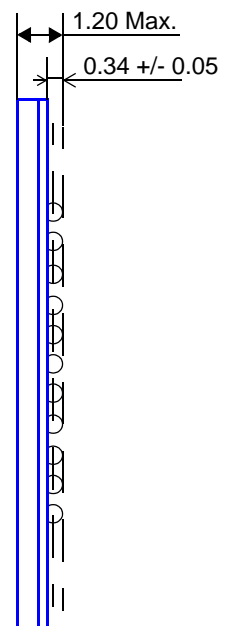

note: all dimension units are Millimeters.

## Package Dimension(x16)

### 84Ball Fine Pitch Ball Grid Array Outline

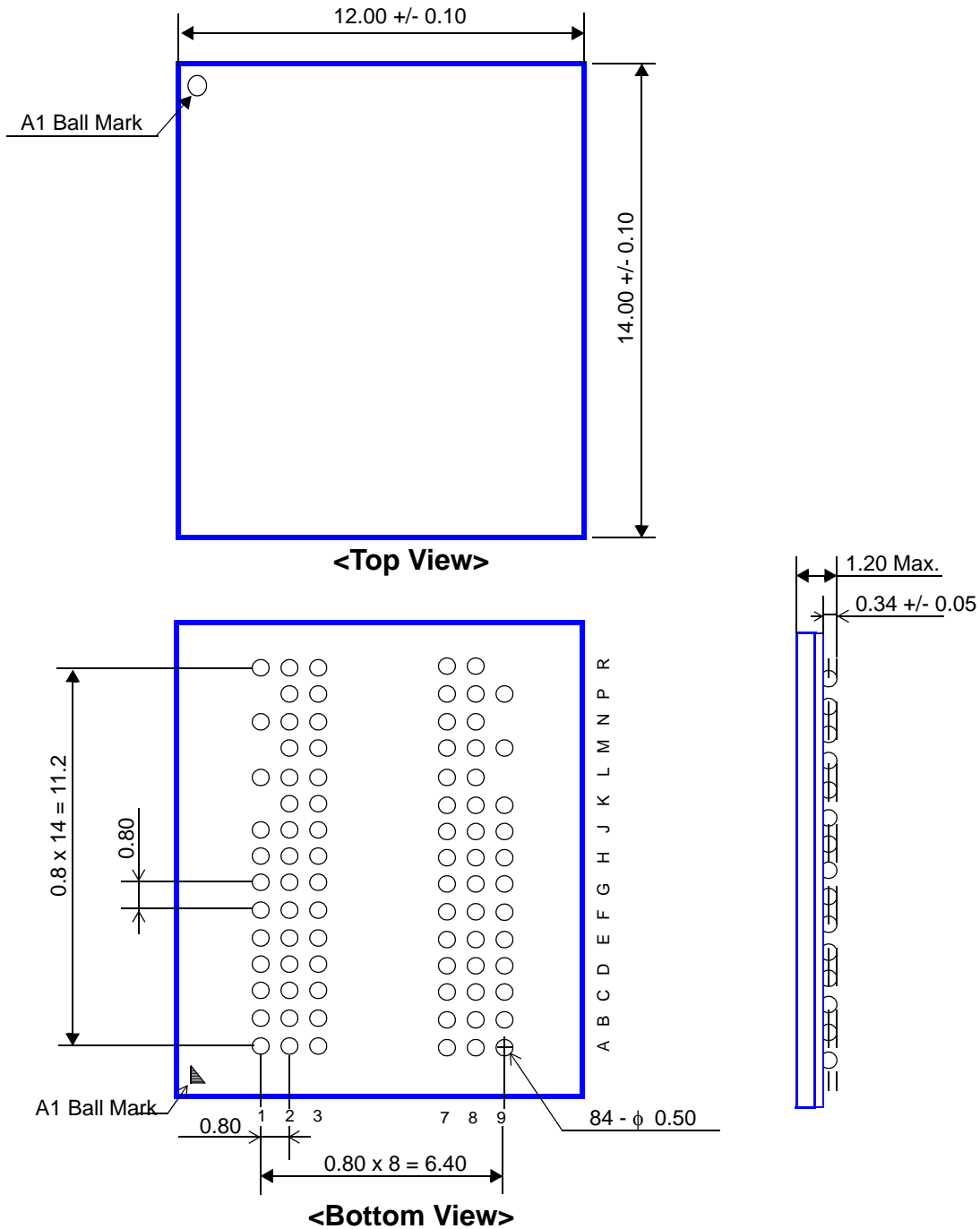

note: all dimension units are Millimeters.