

Low Cost 5V/ ± 5 V 300MHz Triple Video Amplifier in 3mm \times 3mm QFN

FEATURES

- **300MHz Bandwidth on Single 5V and ± 5 V** ($A_V = 1, 2$ and -1)
- **0.1dB Gain Flatness: 150MHz** ($A_V = 1, 2$ and -1)
- **High Slew Rate: 800V/ μ s**
- **Wide Supply Range:**
 - ± 2 V to ± 6 V (Dual Supply)
 - 4V to 12V (Single Supply)
- **80mA Output Current**
- **Low Supply Current: 3.9mA/Amplifier**
- **Shutdown Mode**
- **Fast Turn-On Time: 30ns**
- **Fast Turn-Off Time: 40ns**
- **Small 0.75mm Tall 16-Lead 3mm \times 3mm QFN Package**

APPLICATIONS

- RGB/ $Y_P B_R$ Cable Drivers
- LCD Projectors
- KVM Switches
- A/V Receivers
- MUX Amplifiers
- Composite Video Cable Drivers
- ADC Drivers

DESCRIPTION

The LT[®]6559 is a low cost, high speed, triple amplifier that has been optimized for excellent video performance on a single 5V supply, yet fits in the small footprint of a 3mm \times 3mm QFN package. With a -3 dB bandwidth of 300MHz, a 0.1dB bandwidth of 150MHz, and a slew rate of 800V/ μ s, the LT6559's dynamic performance is an excellent match for high speed RGB or $Y_P B_R$ video applications.

For multiplexing applications such as KVM switches or selectable video inputs, each channel has an independent high speed enable/disable pin. Each amplifier will turn on in 30ns and off in 40ns. When enabled, each amplifier draws 3.9mA from a 5V supply. The LT6559 operates on a single supply voltage ranging from 4V to 12V, and on split supplies ranging from ± 2 V to ± 6 V.

The LT6559 comes in a compact 16-lead 3mm \times 3mm QFN package, and operates over a -40°C to 85°C temperature range. The LT6559 is manufactured on Linear Technology's proprietary complementary bipolar process.

LT, LT, LTC and LTM are registered trademarks of Linear Technology Corporation. All other trademarks are the property of their respective owners.

TYPICAL APPLICATION

3-Input Video MUX Cable Driver

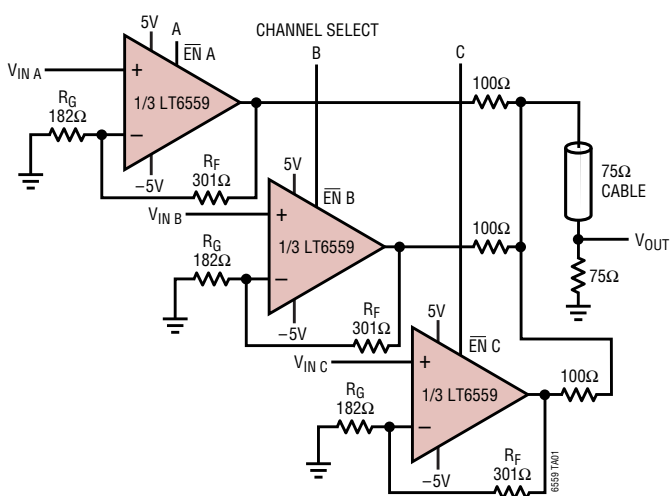

Square Wave Response

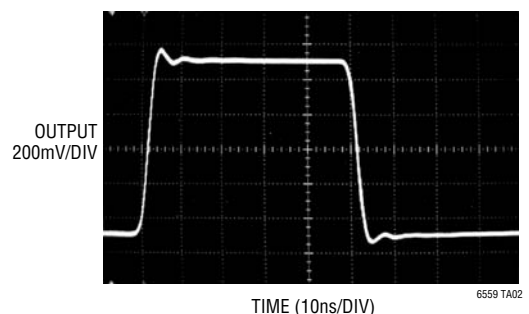

$R_L = 100\Omega$
 $R_F = R_G = 301\Omega$
 $f = 10\text{MHz}$

ABSOLUTE MAXIMUM RATINGS

(Note 1)

Total Supply Voltage (V⁺ to V⁻) 12.6V
 Input Current (Note 2)..... ±10mA
 Output Current ±100mA
 Differential Input Voltage (Note 2) ±5V
 Output Short-Circuit Duration (Note 3) Continuous
 Operating Temperature Range (Note 9) -40°C to 85°C
 Specified Temperature Range (Note 4) .. -40°C to 85°C
 Storage Temperature Range..... -65°C to 125°C
 Junction Temperature (Note 5) 125°C

PACKAGE/ORDER INFORMATION

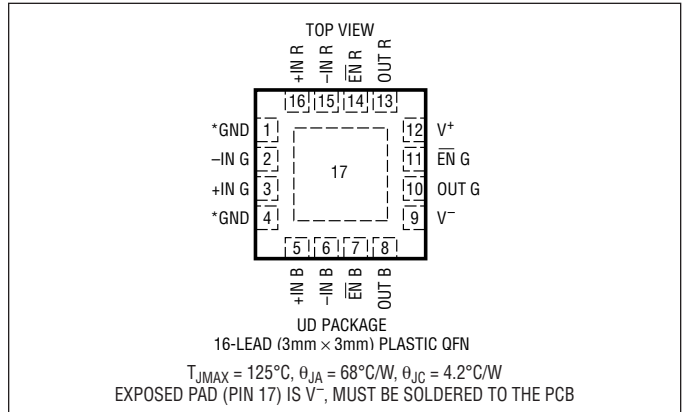

ORDER PART NUMBER	UD PART MARKING
LT6559CUD	LCHG
Order Options Tape and Reel: Add #TR Lead Free: Add #PBF Lead Free Tape and Reel: Add #TRPBF Lead Free Part Marking: http://www.linear.com/leadfree/	

Consult LTC Marketing for parts specified with wider operating temperature ranges.
 * Ground pins are not internally connected. For best channel isolation, connect to ground.

5V ELECTRICAL CHARACTERISTICS The ● denotes specifications which apply over the specified operating temperature range, otherwise specifications are at T_A = 25°C. For each amplifier: V_{CM} = 2.5V, V_S = 5V, EN = 0V, pulse tested, unless otherwise noted. (Note 4)

SYMBOL	PARAMETER	CONDITIONS	MIN	TYP	MAX	UNITS
V _{OS}	Input Offset Voltage			1.5	10	mV
					12	mV
ΔV _{OS} /ΔT	Input Offset Voltage Drift			15		μV/°C
I _{IN+}	Noninverting Input Current			10	25	μA
					30	μA
I _{IN-}	Inverting Input Current			10	60	μA
					70	μA
e _n	Input Noise Voltage Density	f = 1kHz, R _F = 1k, R _G = 10Ω, R _S = 0Ω		4.5		nV/√Hz
+i _n	Noninverting Input Noise Current Density	f = 1kHz		6		pA/√Hz
-i _n	Inverting Input Noise Current Density	f = 1kHz		25		pA/√Hz
R _{IN}	Input Resistance	V _{IN} = ±1V		0.14		MΩ
C _{IN}	Input Capacitance	Amplifier Enabled Amplifier Disabled		2.0 2.5		pF pF
C _{OUT}	Output Capacitance	Amplifier Disabled		8.5		pF
V _{INH}	Input Voltage Range, High		3.5	4.0		V
V _{INL}	Input Voltage Range, Low			1.0	1.5	V
V _{OUTH}	Maximum Output Voltage Swing, High	R _L = 100k	4.1	4.15		V
V _{OUTL}	Maximum Output Voltage Swing, Low	R _L = 100k		0.85	0.9	V
V _{OUTH}	Maximum Output Voltage Swing, High	R _L = 150Ω R _L = 150Ω	3.85 3.65	3.95		V V

6559f

5V ELECTRICAL CHARACTERISTICS The ● denotes specifications which apply over the specified operating temperature range, otherwise specifications are at $T_A = 25^\circ\text{C}$. For each amplifier: $V_{CM} = 2.5\text{V}$, $V_S = 5\text{V}$, $\overline{\text{EN}} = 0\text{V}$, pulse tested, unless otherwise noted. (Note 4)

SYMBOL	PARAMETER	CONDITIONS	MIN	TYP	MAX	UNITS
V_{OUTL}	Maximum Output Voltage Swing, Low	$R_L = 150\Omega$ $R_L = 150\Omega$		1.05	1.15 1.35	V V
CMRR	Common Mode Rejection Ratio	$V_{CM} = 1.5\text{V}$ to 3.5V	40	50		dB
PSRR	Power Supply Rejection Ratio	$V_S = \pm 2\text{V}$ to $\pm 5\text{V}$, $\overline{\text{EN}} = V^-$	56	70		dB
R_{OL}	Transimpedance, $\Delta V_{OUT}/\Delta I_{IN}^-$	$V_{OUT} = 1.5\text{V}$ to 3.5V , $R_L = 150\Omega$	40	80		$k\Omega$
I_{OUT}	Maximum Output Current	$R_L = 0\Omega$		65		mA
I_S	Supply Current per Amplifier			3.9	6.1	mA
	Disable Supply Current per Amplifier	$\overline{\text{EN}}$ Pin Voltage = 4.5V , $R_L = 150\Omega$		0.1	100	μA
$I_{\overline{\text{EN}}}$	Enable Pin Current			30		μA
SR	Slew Rate (Note 6)	$A_V = 10$, $R_L = 150\Omega$, $V_S = \pm 5\text{V}$		500		$\text{V}/\mu\text{s}$
t_{ON}	Turn-On Delay Time (Note 7)	$R_F = R_G = 301\Omega$, $R_L = 150\Omega$, $V_S = \pm 5\text{V}$		30	75	ns
t_{OFF}	Turn-Off Delay Time (Note 7)	$R_F = R_G = 301\Omega$, $R_L = 150\Omega$, $V_S = \pm 5\text{V}$		40	100	ns
t_r , t_f	Small-Signal Rise and Fall Time	$R_F = R_G = 301\Omega$, $R_L = 150\Omega$, $V_{OUT} = 1\text{V}_{P-P}$, $V_S = \pm 5\text{V}$		1.3		ns
t_{PD}	Propagation Delay	$R_F = R_G = 301\Omega$, $R_L = 150\Omega$, $V_{OUT} = 1\text{V}_{P-P}$, $V_S = \pm 5\text{V}$		2.5		ns
os	Small-Signal Overshoot	$R_F = R_G = 301\Omega$, $R_L = 150\Omega$, $V_{OUT} = 1\text{V}_{P-P}$, $V_S = \pm 5\text{V}$		10		%
t_S	Settling Time	0.1%, $A_V = -1\text{V}$, $R_F = R_G = 301\Omega$, $R_L = 150\Omega$, $V_S = \pm 5\text{V}$		25		ns
dG	Differential Gain (Note 8)	$R_F = R_G = 301\Omega$, $R_L = 150\Omega$, $V_S = \pm 5\text{V}$		0.13		%
dP	Differential Phase (Note 8)	$R_F = R_G = 301\Omega$, $R_L = 150\Omega$, $V_S = \pm 5\text{V}$		0.10		DEG

$\pm 5\text{V}$ ELECTRICAL CHARACTERISTICS The ● denotes specifications which apply over the specified operating temperature range, otherwise specifications are at $T_A = 25^\circ\text{C}$. For each amplifier: $V_{CM} = 0\text{V}$, $V_S = \pm 5\text{V}$, $\overline{\text{EN}} = 0\text{V}$, pulse tested, unless otherwise noted. (Note 4)

SYMBOL	PARAMETER	CONDITIONS	MIN	TYP	MAX	UNITS
V_{OS}	Input Offset Voltage			1.5	10	mV
$\Delta V_{OS}/\Delta T$	Input Offset Voltage Drift			15		$\mu\text{V}/^\circ\text{C}$
I_{IN}^+	Noninverting Input Current			10	25	μA
I_{IN}^-	Inverting Input Current			10	60	μA
e_n	Input Noise Voltage Density	$f = 1\text{kHz}$, $R_F = 1\text{k}$, $R_G = 10\Omega$, $R_S = 0\Omega$		4.5		$\text{nV}/\sqrt{\text{Hz}}$
$+i_n$	Noninverting Input Noise Current Density	$f = 1\text{kHz}$		6		$\text{pA}/\sqrt{\text{Hz}}$
$-i_n$	Inverting Input Noise Current Density	$f = 1\text{kHz}$		25		$\text{pA}/\sqrt{\text{Hz}}$
R_{IN}	Input Resistance	$V_{IN} = \pm 3.5\text{V}$		1		$\text{M}\Omega$
C_{IN}	Input Capacitance	Amplifier Enabled Amplifier Disabled		2.0 2.5		pF pF
C_{OUT}	Output Capacitance	Amplifier Disabled		8.5		pF
V_{INH}	Input Voltage Range, High	$V_S = \pm 5\text{V}$	3.5	4.0		V
V_{INL}	Input Voltage Range, Low			-4.0	-3.5	V
V_{OUTH}	Maximum Output Voltage Swing, High	$R_L = 100\text{k}$	4.0	4.2		V

6559f

±5V ELECTRICAL CHARACTERISTICS

The ● denotes specifications which apply over the specified operating temperature range, otherwise specifications are at $T_A = 25^\circ\text{C}$. For each amplifier: $V_{CM} = 0\text{V}$, $V_S = \pm 5\text{V}$, $\overline{\text{EN}} = 0\text{V}$, pulse tested, unless otherwise noted. (Note 4)

SYMBOL	PARAMETER	CONDITIONS	MIN	TYP	MAX	UNITS
V_{OUTL}	Maximum Output Voltage Swing, Low	$R_L = 100\text{k}$		-4.2	-4.0	V
V_{OUTH}	Maximum Output Voltage Swing, High	$R_L = 150\Omega$ $R_L = 150\Omega$	● 3.4 3.2	3.6		V V
V_{OUTL}	Maximum Output Voltage Swing, Low	$R_L = 150\Omega$ $R_L = 150\Omega$	●	-3.6	-3.4 -3.2	V V
CMRR	Common Mode Rejection Ratio	$V_{CM} = \pm 3.5\text{V}$		42	52	dB
PSRR	Power Supply Rejection Ratio	$V_S = \pm 2\text{V}$ to $\pm 5\text{V}$, $\overline{\text{EN}} = V^-$		56	70	dB
R_{OL}	Transimpedance, $\Delta V_{OUT}/\Delta I_{IN^-}$	$V_{OUT} = \pm 2\text{V}$, $R_L = 150\Omega$		40	100	k Ω
I_{OUT}	Maximum Output Current	$R_L = 0\Omega$		100		mA
I_S	Supply Current per Amplifier	$V_{OUT} = 0\text{V}$	●	4.6	6.5	mA
	Disable Supply Current per Amplifier	$\overline{\text{EN}}$ Pin Voltage = 4.5V, $R_L = 150\Omega$	●	0.1	100	μA
$I_{\overline{\text{EN}}}$	Enable Pin Current			30		μA
SR	Slew Rate (Note 6)	$A_V = 10$, $R_L = 150\Omega$		500	800	V/ μs
t_{ON}	Turn-On Delay Time (Note 7)	$R_F = R_G = 301\Omega$, $R_L = 150\Omega$		30	75	ns
t_{OFF}	Turn-Off Delay Time (Note 7)	$R_F = R_G = 301\Omega$, $R_L = 150\Omega$		40	100	ns
t_r , t_f	Small-Signal Rise and Fall Time	$R_F = R_G = 301\Omega$, $R_L = 150\Omega$, $V_{OUT} = 1\text{V}_{P-P}$		1.3		ns
t_{PD}	Propagation Delay	$R_F = R_G = 301\Omega$, $R_L = 150\Omega$, $V_{OUT} = 1\text{V}_{P-P}$		2.5		ns
os	Small-Signal Overshoot	$R_F = R_G = 301\Omega$, $R_L = 150\Omega$, $V_{OUT} = 1\text{V}_{P-P}$		10		%
t_S	Settling Time	0.1%, $A_V = -1$, $R_F = R_G = 301\Omega$, $R_L = 150\Omega$		25		ns
dG	Differential Gain (Note 8)	$R_F = R_G = 301\Omega$, $R_L = 150\Omega$		0.13		%
dP	Differential Phase (Note 8)	$R_F = R_G = 301\Omega$, $R_L = 150\Omega$		0.10		DEG

Note 1: Stresses beyond those listed under Absolute Maximum Ratings may cause permanent damage to the device. Exposure to any Absolute Maximum Rating condition for extended periods may affect device reliability and lifetime.

Note 2: This parameter is guaranteed to meet specified performance through design and characterization. It has not been tested.

Note 3: A heat sink may be required depending on the power supply voltage and how many amplifiers have their outputs short circuited.

Note 4: The LT6559 is guaranteed to meet specified performance from 0°C to 70°C and is designed, characterized and expected to meet these extended temperature limits, but is not tested or QA sampled at -40°C and 85°C .

Note 5: T_J is calculated from the ambient temperature T_A and the power dissipation P_D according to the following formula: $T_J = T_A + (P_D \cdot 68^\circ\text{C/W})$

Note 6: At $\pm 5\text{V}$, slew rate is measured at $\pm 2\text{V}$ on a $\pm 3\text{V}$ output signal. At 5V , slew rate is measured from 2V to 3V on a 1.5V to 3.5V output signal. Slew

rate is 100% production tested at $\pm 5\text{V}$ for both the rising and falling edge of the B channel. The slew rate of the R and G channels is guaranteed through design and characterization.

Note 7: Turn-on delay time (t_{ON}) is measured from control input to appearance of 1V at the output, for $V_{IN} = 1\text{V}$. Likewise, turn-off delay time (t_{OFF}) is measured from control input to appearance of 0.5V on the output for $V_{IN} = 0.5\text{V}$. This specification is guaranteed by design and characterization.

Note 8: Differential gain and phase are measured using a Tektronix TSG120YC/NTSC signal generator and a Tektronix 1780R Video Measurement Set. The resolution of this equipment is 0.1% and 0.1° . Ten identical amplifier stages were cascaded giving an effective resolution of 0.01% and 0.01° .

Note 9: The LT6559 is guaranteed functional over the operating temperature range of -40°C to 85°C .

TYPICAL AC PERFORMANCE

V_S (V)	A_V	R_L (Ω)	R_F (Ω)	R_G (Ω)	SMALL SIGNAL -3dB BW (MHz)	SMALL SIGNAL 0.1dB BW (MHz)	SMALL SIGNAL PEAKING (dB)
± 5 , 5	1	150	365	-	300	150	0.05
± 5 , 5	2	150	301	301	300	150	0
± 5 , 5	-1	150	301	301	300	150	0

6559f

TYPICAL PERFORMANCE CHARACTERISTICS

Closed-Loop Gain vs Frequency
($A_V = 1$)

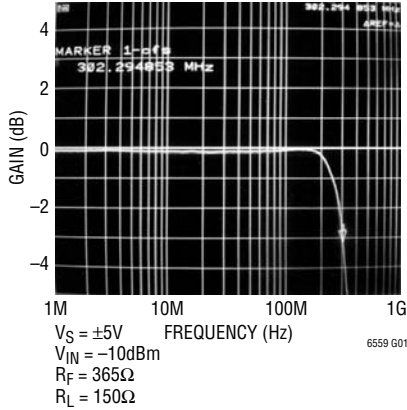

Closed-Loop Gain vs Frequency
($A_V = 2$)

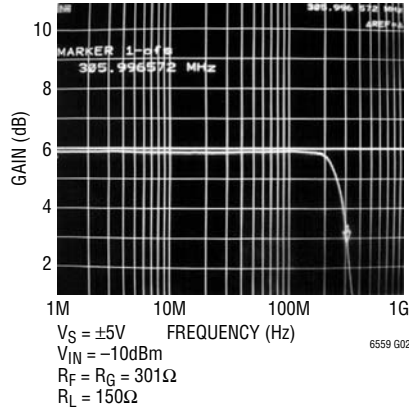

Closed-Loop Gain vs Frequency
($A_V = -1$)

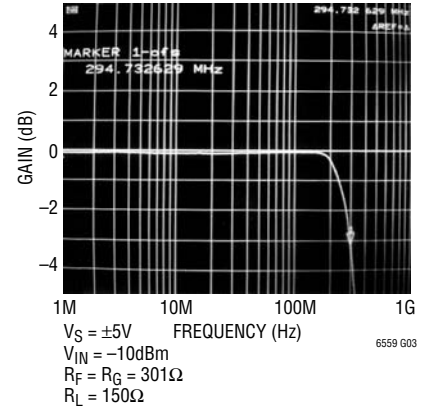

Large-Signal Transient Response
($A_V = 1$)

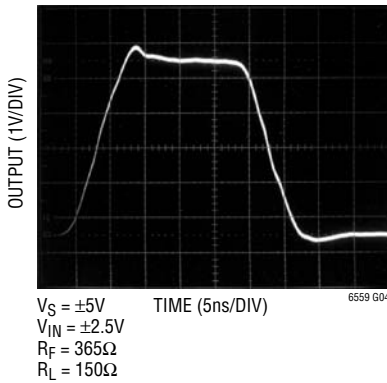

Large-Signal Transient Response
($A_V = 2$)

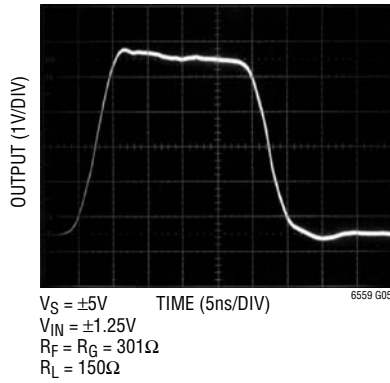

Large-Signal Transient Response
($A_V = -1$)

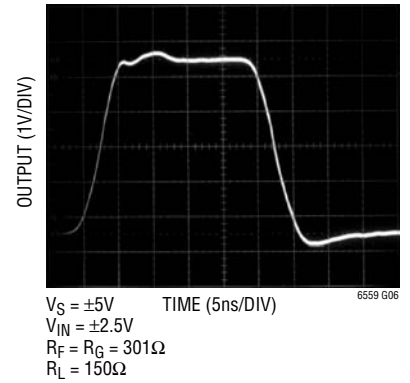

2nd and 3rd Harmonic Distortion vs Frequency

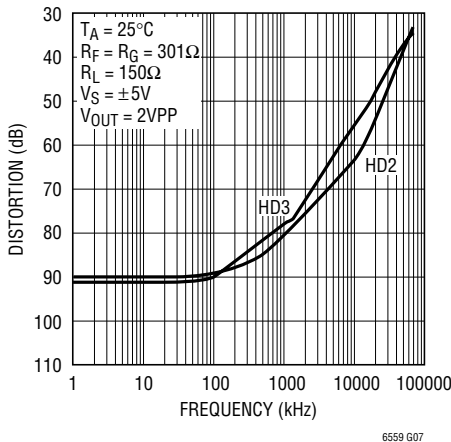

Maximum Undistorted Output Voltage vs Frequency

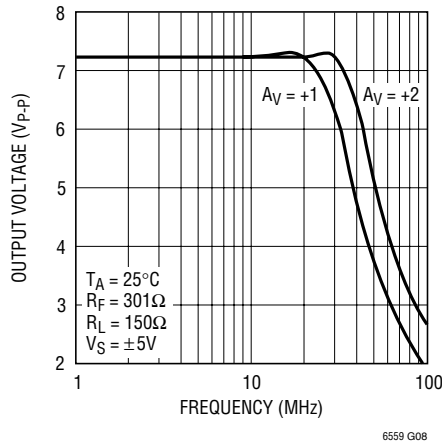

PSRR vs Frequency

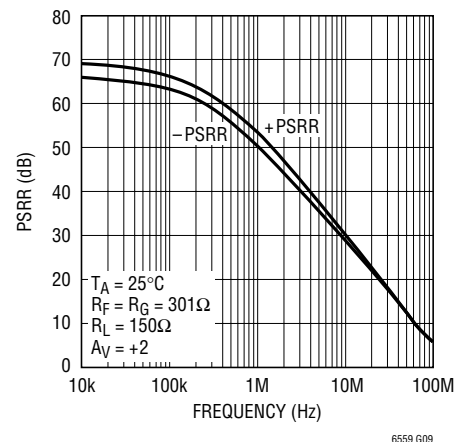

TYPICAL PERFORMANCE CHARACTERISTICS

Input Voltage Noise and Current Noise vs Frequency

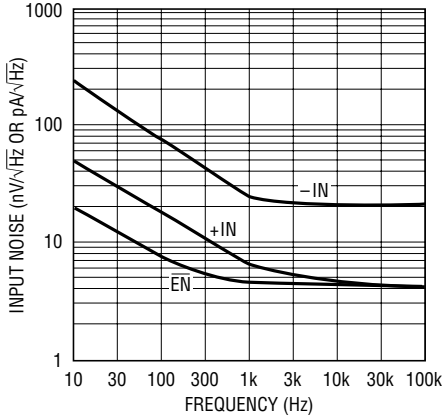

6559 G10

Output Impedance vs Frequency

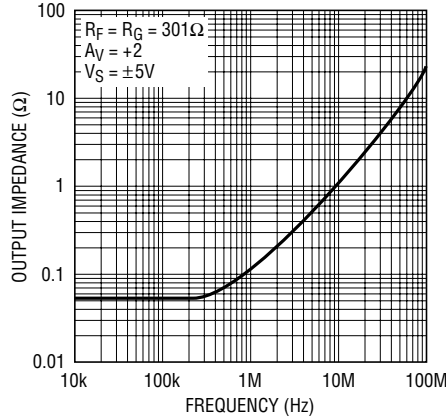

6559 G11

Output Impedance (Disabled) vs Frequency

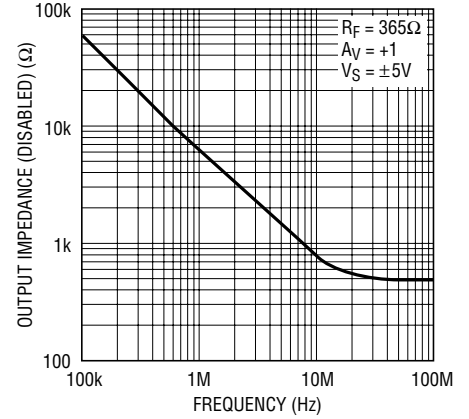

6559 G12

Maximum Capacitive Load vs Feedback Resistor

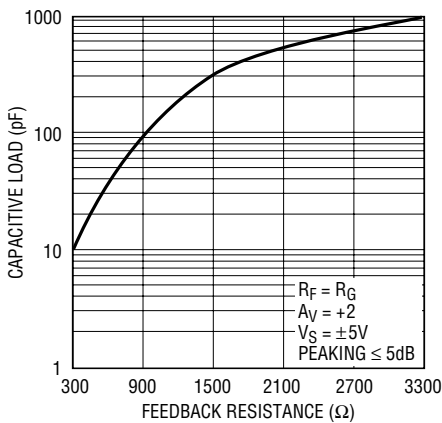

6559 G13

Capacitive Load vs Output Series Resistor

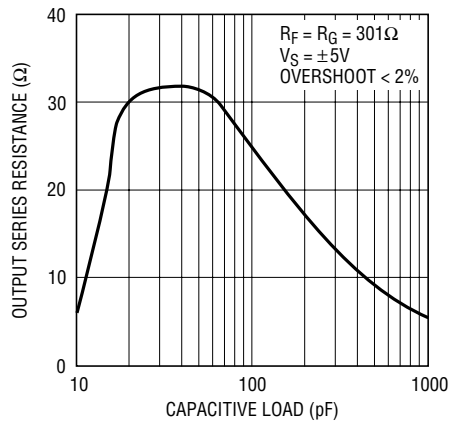

6559 G14

Supply Current per Amplifier vs Supply Voltage

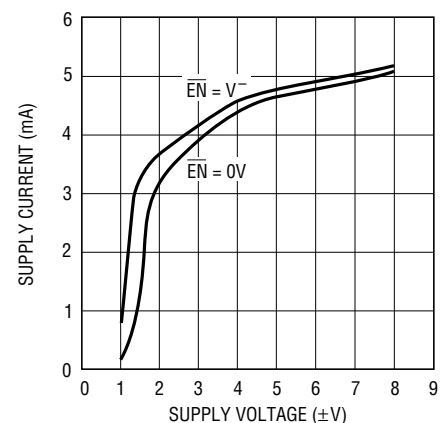

6559 G15

Output Voltage Swing vs Temperature

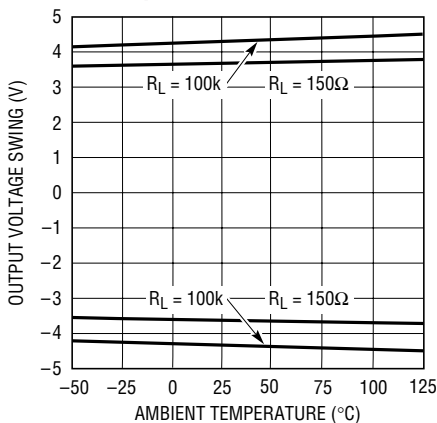

6559 G16

Enable Pin Current vs Temperature

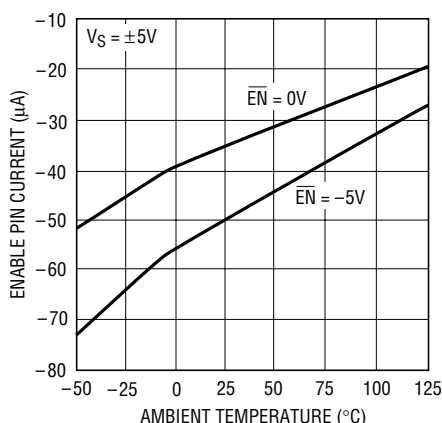

6559 G17

Positive Supply Current per Amplifier vs Temperature

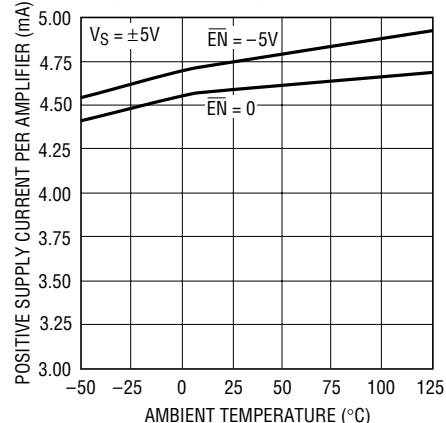

6559 G18

TYPICAL PERFORMANCE CHARACTERISTICS

Input Offset Voltage vs Temperature

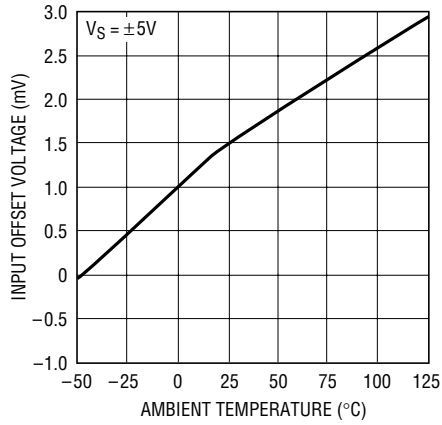

6559 G19

Input Bias Currents vs Temperature

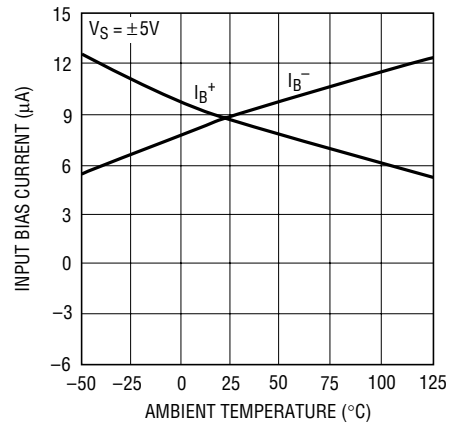

6559 G20

All Hostile Crosstalk

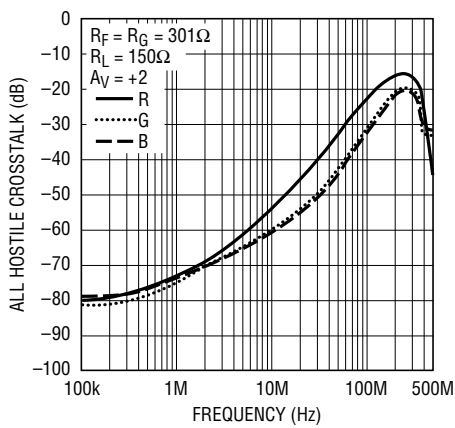

6559 G21

All Hostile Crosstalk (Disabled)

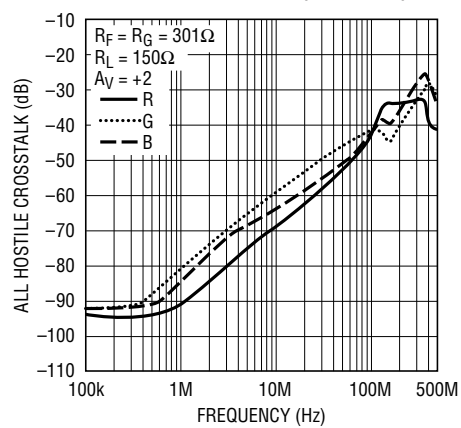

6559 G24

Propagation Delay

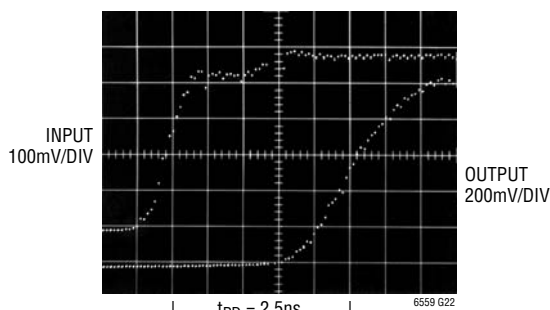

6559 G22

$A_V = +2$
 $R_L = 150\Omega$
 $R_F = R_G = 301\Omega$

Rise Time and Overshoot

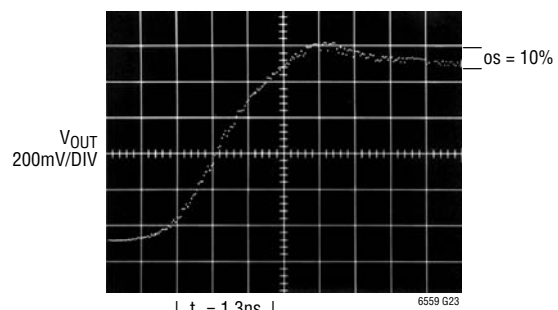

6559 G23

$A_V = +2$
 $R_L = 150\Omega$
 $R_F = R_G = 301\Omega$

PIN FUNCTIONS

GND (Pins 1, 4): Ground. Not connected internally.

-IN G (Pin 2): Inverting Input of G Channel Amplifier.

+IN G (Pin 3): Noninverting Input of G Channel Amplifier.

+IN B (Pin 5): Noninverting Input of B Channel Amplifier.

-IN B (Pin 6): Inverting Input of B Channel Amplifier.

$\overline{\text{EN}} \text{ B (Pin 7)}$: B Channel Enable Pin. Logic low to enable.

OUT B (Pin 8): B Channel Output.

V^- (Pin 9): Negative Supply Voltage, Usually Ground or $-5V$.

OUT G (Pin 10): G Channel Output.

$\overline{\text{EN}} \text{ G (Pin 11)}$: G Channel Enable Pin. Logic low to enable.

V^+ (Pin 12): Positive Supply Voltage, Usually 5V.

OUT R (Pin 13): R Channel Output.

$\overline{\text{EN}} \text{ R (Pin 14)}$: R Channel Enable Pin. Logic low to enable.

-IN R (Pin 15): Inverting Input of R Channel Amplifier.

+IN R (Pin 16): Noninverting Input of R Channel Amplifier.

Exposed Pad (Pin 17): V^- . Must Be Soldered to the PCB.

APPLICATIONS INFORMATION

Feedback Resistor Selection

The small-signal bandwidth of the LT6559 is set by the external feedback resistors and the internal junction capacitors. As a result, the bandwidth is a function of the supply voltage, the value of the feedback resistor, the closed-loop gain and the load resistor. Optimized for $\pm 5V$ and single-supply 5V operation, the LT6559 has a $-3dB$ bandwidth of 300MHz at gains of +1, -1 , or +2. Refer to the resistor selection guide in the Typical AC Performance table.

Capacitance on the Inverting Input

Current feedback amplifiers require resistive feedback from the output to the inverting input for stable operation. Take care to minimize the stray capacitance between the output and the inverting input. Capacitance on the inverting input to ground will cause peaking in the frequency response and overshoot in the transient response.

Capacitive Loads

The LT6559 can drive many capacitive loads directly when the proper value of feedback resistor is used. The required value for the feedback resistor will increase as load capacitance increases and as closed-loop gain decreases. Alternatively, a small resistor (5Ω to 35Ω) can be put in series with the output to isolate the capacitive load from the amplifier output. This has the advantage that the ampli-

fier bandwidth is only reduced when the capacitive load is present. The disadvantage is that the gain is a function of the load resistance.

Power Supplies

The LT6559 will operate from single or split supplies from $\pm 2V$ (4V total) to $\pm 6V$ (12V total). It is not necessary to use equal value split supplies, however the offset voltage and inverting input bias current will change. The offset voltage changes about $600\mu V$ per volt of supply mismatch. The inverting bias current will typically change about $2\mu A$ per volt of supply mismatch.

Slew Rate

Unlike a traditional voltage feedback op amp, the slew rate of a current feedback amplifier is dependent on the amplifier gain configuration. In a current feedback amplifier, both the input stage and the output stage have slew rate limitations. In the inverting mode, and for gains of 2 or more in the noninverting mode, the signal amplitude between the input pins is small and the overall slew rate is that of the output stage. For gains less than 2 in the noninverting mode, the overall slew rate is limited by the input stage.

The input slew rate of the LT6559 is approximately $600V/\mu s$ and is set by internal currents and capacitances. The output slew rate is set by the value of the feedback resistor and

6559f

APPLICATIONS INFORMATION

internal capacitance. At a gain of 2 with 301Ω feedback and gain resistors and ±5V supplies, the output slew rate is typically 800V/μs. Larger feedback resistors will reduce the slew rate as will lower supply voltages.

Enable/Disable

Each amplifier of the LT6559 has a unique high impedance, zero supply current mode which is controlled by its own \overline{EN} pin. These amplifiers are designed to operate with CMOS logic; the amplifiers draw 0.1μA of current when these pins are high or floated. To activate each amplifier, its \overline{EN} pin is normally pulled to a logic low. However, supply current will vary as the voltage between the V^+ supply and \overline{EN} is varied. As seen in Figure 1, I_S does vary with $(V^+ - V_{\overline{EN}})$, particularly when the voltage difference is less than 3V. For normal operation, it is important to keep the \overline{EN} pin at least 3V below the V^+ supply. If a V^+ of less than 3V is used, for the amplifier to remain enabled at all times the \overline{EN} pin should be tied to the V^- supply. The enable pin current is approximately 30μA when activated. If using CMOS open-drain logic, an external 1k pull-up resistor is recommended to ensure that the LT6559 remains disabled regardless of any CMOS drain-leakage currents.

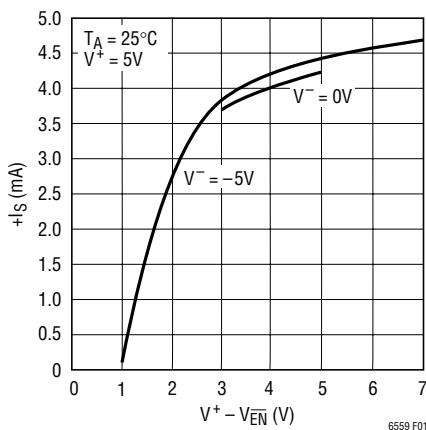

Figure 1. I_S vs $(V^+ - V_{\overline{EN}})$

The enable/disable times are very fast when driven from standard 5V CMOS logic. Each amplifier enables in about 30ns (50% point to 50% point) while operating on ±5V supplies (Figure 2). Likewise, the disable time is approximately 40ns (50% point to 50% point) (Figure 3).

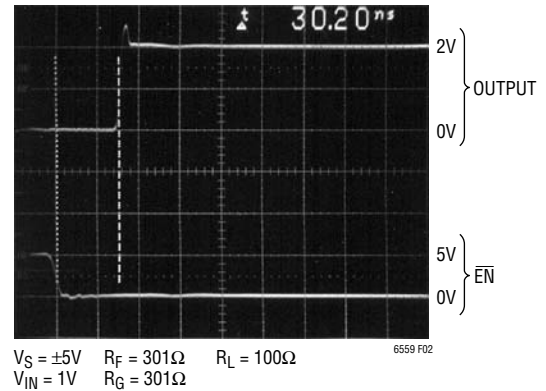

Figure 2. Amplifier Enable Time, $A_V = 2$

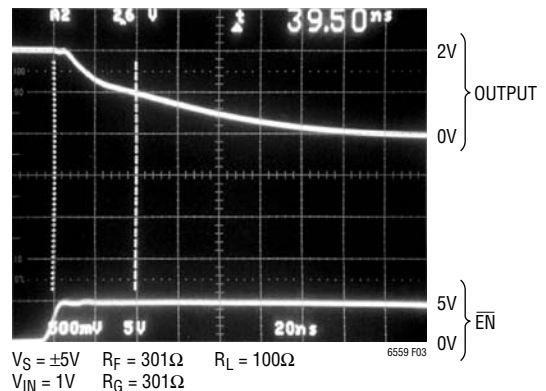

Figure 3. Amplifier Disable Time, $A_V = 2$

Differential Input Signal Swing

To avoid any breakdown condition on the input transistors, the differential input swing must be limited to ±5V. In normal operation, the differential voltage between the input pins is small, so the ±5V limit is not an issue. In the disabled mode however, the differential swing can be the same as the input swing, and there is a risk of device breakdown if the input voltage range has not been properly considered.

TYPICAL APPLICATIONS

3-Input Video MUX Cable Driver

The application on the first page of this data sheet shows a low cost, 3-input video MUX cable driver. The scope photo below (Figure 4) displays the cable output of a 30MHz square wave driving 150Ω. In this circuit the active amplifier is loaded by the sum of R_F and R_G of each disabled amplifier. Resistor values have been chosen to keep the total back termination at 75Ω while maintaining a gain of 1 at the 75Ω load. The switching time between any two channels is approximately 32ns when both enable pins are driven (Figure 5).

When building the board, care was taken to minimize trace lengths at the inverting inputs. The ground plane was also pulled a few millimeters away from R_F and R_G on both sides of the board to minimize stray capacitance.

Using the LT6559 to Drive LCD Displays

Driving a variety of XGA and UXGA LCD displays can be a difficult problem because they are usually a capacitive load of over 300pF, and require fast settling.

The LT6559 is particularly well suited for driving these LCD displays because it can drive large capacitive loads with a small series resistor at the output, minimizing settling time. As seen in Figure 6, at a gain of +3 with a 16.9Ω output series resistor and a 330pF load, the LT6559 is capable of settling to 0.1% in 30ns for a 6V step.

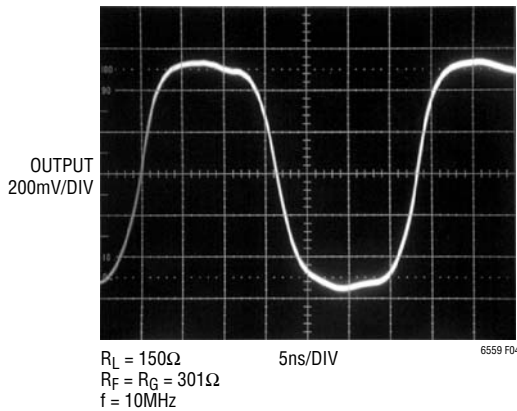

Figure 4. Square Wave Response

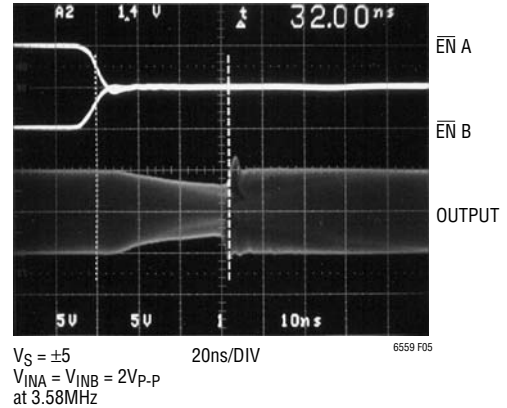

Figure 5. 3-Input Video MUX Switching Response ($A_V = 2$)

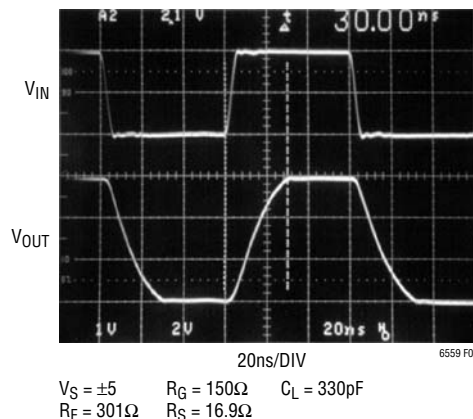

Figure 6. Large-Signal Pulse Response

TYPICAL APPLICATIONS

Y_PB_PR to RGB Conversion

Two LT6559s can be used to map the Y_PB_PR “component” video into the RGB color space as shown in Figure 8. The Y input is properly terminated with 75Ω and buffered with a gain of 2 by amplifier A2. The P_R input is terminated and buffered with a gain of 2.8 by amplifier A1. The P_B input is terminated and buffered with a gain of 3.6 by amplifier A3.

Amplifier B1 performs an equally weighted addition of amplifiers A1 and A2 outputs, thereby producing 2(Y + 1.4P_R), which generates the desired R signal at the terminated load due to the voltage division by 2 caused by the termination resistors. Amplifier B3 forms the equally weighted addition of amplifiers A2 and A3 outputs, thereby producing 2(Y + 1.8P_B), which generates the desired B signal at the terminated load.

Amplifier B2 performs a weighted summation of all three inputs. The P_B signal is amplified overall by:

$$\frac{-301}{1.54k} \cdot 3.6 = 2(-0.34)$$

The P_R signal is amplified overall by:

$$\frac{-301}{590} \cdot 2.8 = 2(-0.71)$$

The Y signal is amplified overall by:

$$\frac{1k}{1k + 698} \cdot 1 + \frac{301}{590 \parallel 1.54k} \cdot 2 = 2(1)$$

Therefore the amplifier B2 output is:

$$2(Y - 0.34P_B - 0.71P_R)$$

which generates the desired G signal at the terminated load.

The sync present on the Y input is reconstructed on all three R, G, and B outputs.

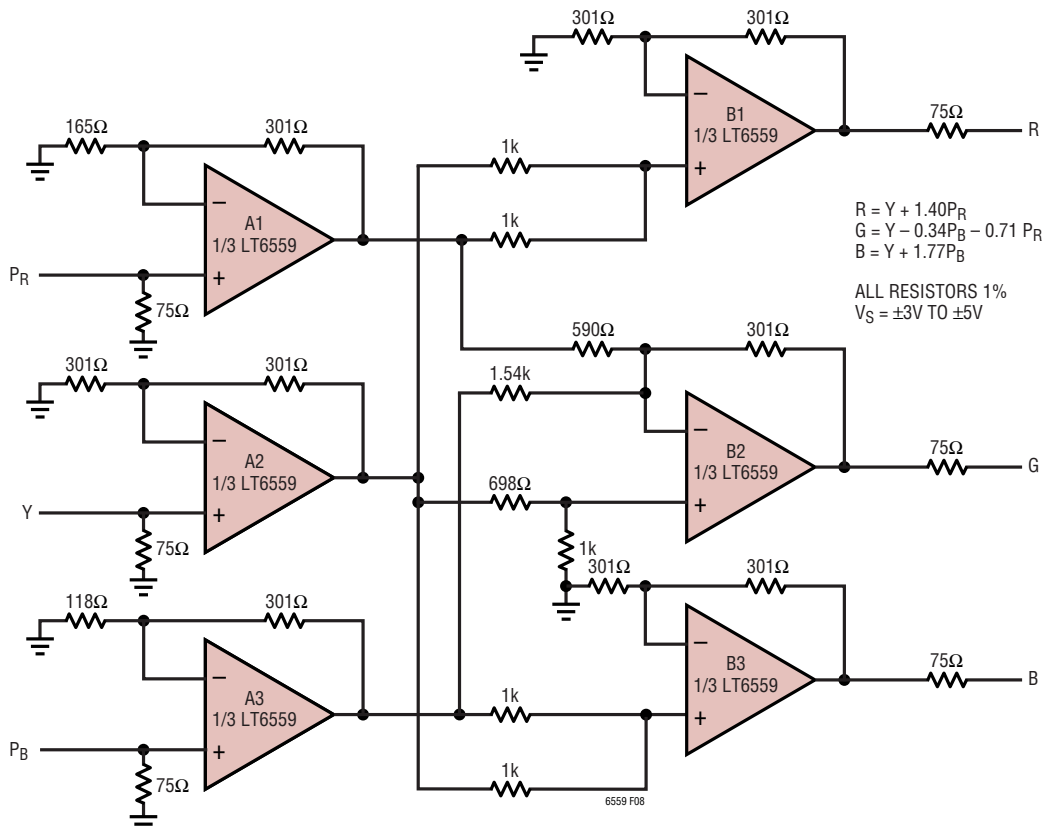

Figure 8. Y_PB_PR to RGB Conversion

TYPICAL APPLICATIONS

Application (Demo) Boards

The DC1063A demo board has been created for evaluating the LT6559 and is available directly from Linear Technology. It has been designed as an RGB video buffer/cable driver, using standard VGA 15-pin D-Sub (HD-15) connectors for input and output signals. All sync signals are also passed directly from the input to the output, so the LT6559's performance can be determined by applying a 5V supply to the DC1063A demo board and then inserting the board between a computer's analog video output and

a monitor. Schematics for the DC1063A demo board can be found on the back page of this datasheet.

As seen in the DC1063A schematic, each amplifier is configured in a gain of 2, with a 75Ω back-termination resulting in a final gain of 1. Each input is properly terminated for 75Ω input impedance with AC coupling capacitors at each input and output. Additionally, for proper operation, the positive input of each amplifier is biased to mid-supply with a high impedance resistor divider.

As seen below, the DC1063A is a 2-sided board.

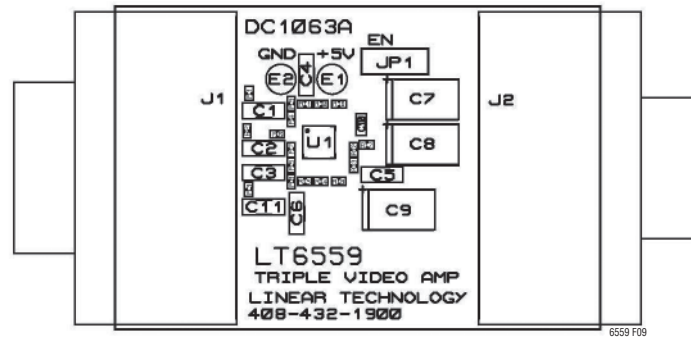

Figure 9. DC1063A Component Locator

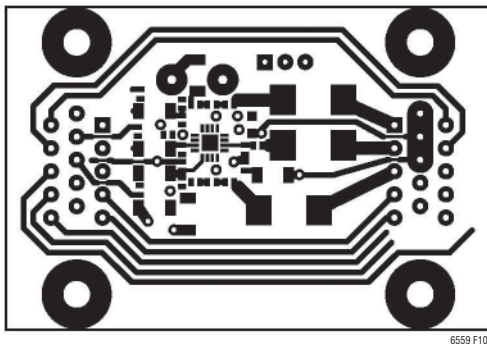

Figure 10. DC1063A Top Side

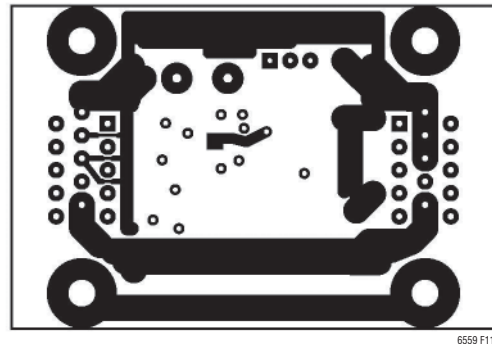
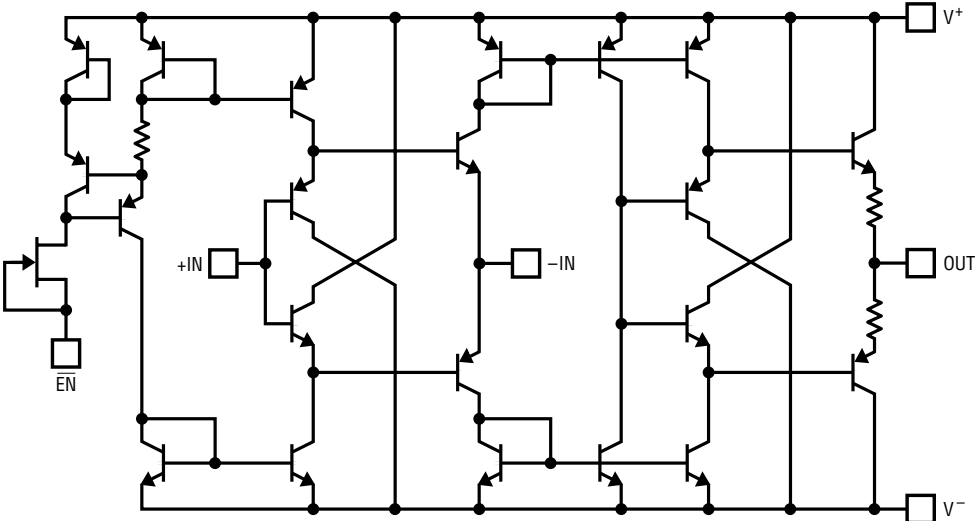

Figure 11. DC1063A Bottom Side

SIMPLIFIED SCHEMATIC, each amplifier



6559 SS

PACKAGE DESCRIPTION

UD Package
16-Lead Plastic QFN (3mm × 3mm)
 (Reference LTC DWG # 05-08-1691)

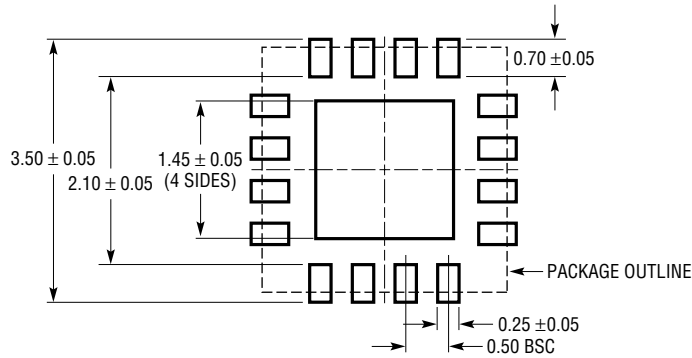

RECOMMENDED SOLDER PAD PITCH AND DIMENSIONS

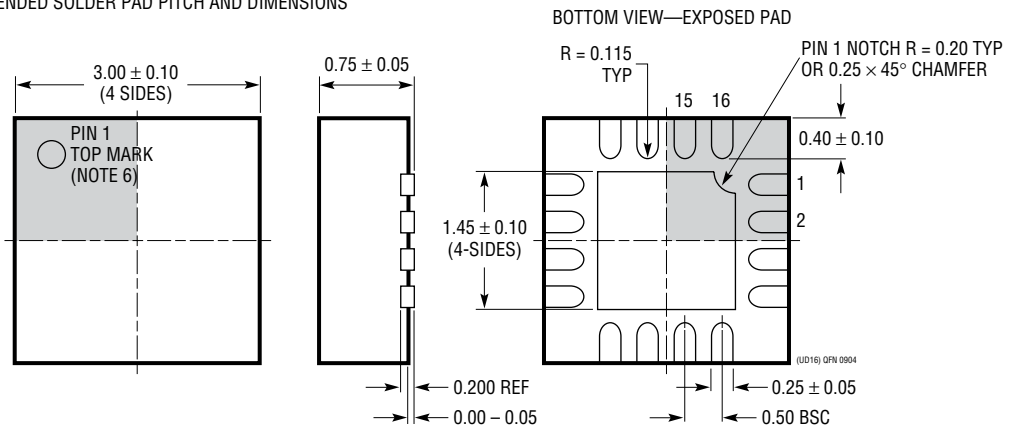

- NOTE:
1. DRAWING CONFORMS TO JEDEC PACKAGE OUTLINE MO-220 VARIATION (WEED-2)
 2. DRAWING NOT TO SCALE
 3. ALL DIMENSIONS ARE IN MILLIMETERS
 4. DIMENSIONS OF EXPOSED PAD ON BOTTOM OF PACKAGE DO NOT INCLUDE MOLD FLASH. MOLD FLASH, IF PRESENT, SHALL NOT EXCEED 0.15mm ON ANY SIDE
 5. EXPOSED PAD SHALL BE SOLDER PLATED
 6. SHADED AREA IS ONLY A REFERENCE FOR PIN 1 LOCATION ON THE TOP AND BOTTOM OF PACKAGE

TYPICAL APPLICATION

DC1063A Demo Circuit Schematic

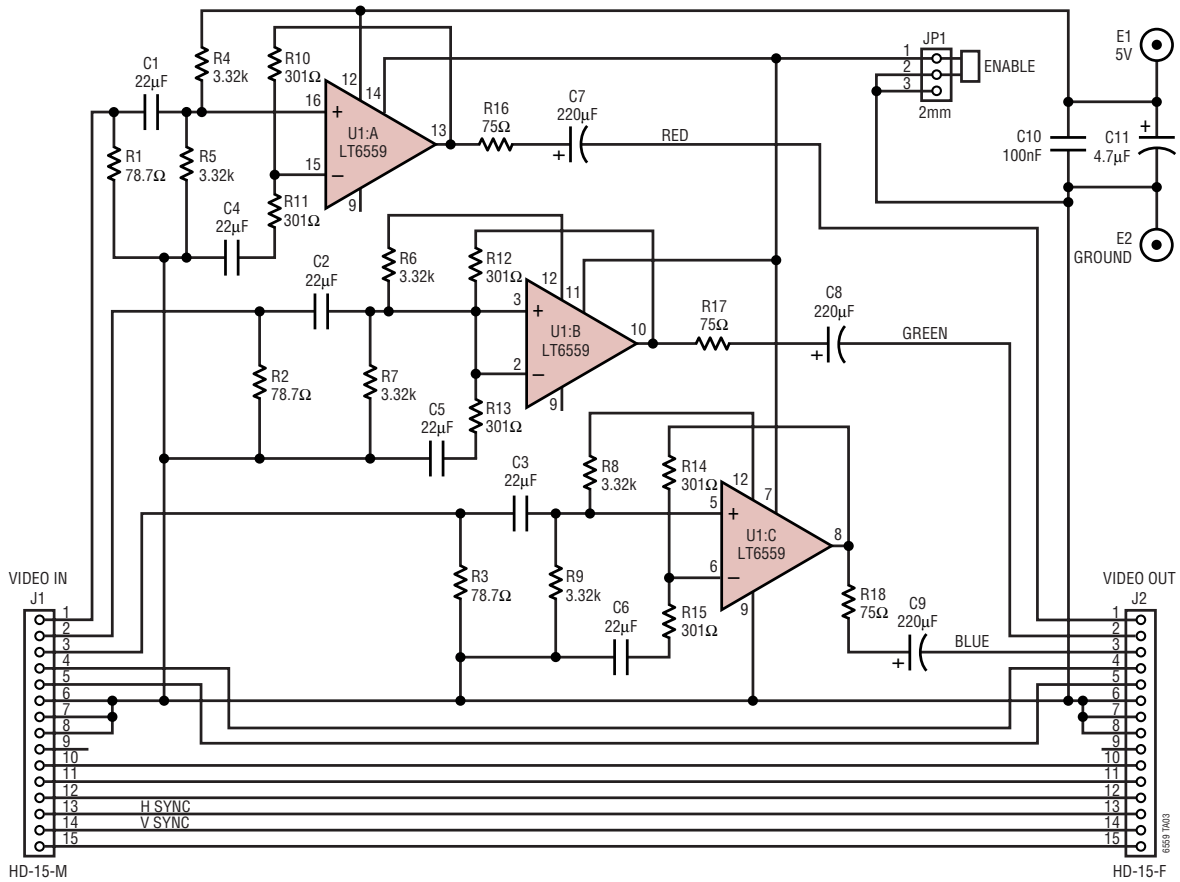

RELATED PARTS

PART NUMBER	DESCRIPTION	COMMENTS
LT1203/LT1205	150MHz Video Multiplexers	2:1 and Dual 2:1 MUXs with 25ns Switch Time
LT1204	4-Input Video MUX with Current Feedback Amplifier	Cascadable Enable 64:1 Multiplexing
LT1395/LT1396/LT1397	Single/Dual/Quad Current Feedback Amplifiers	400MHz Bandwidth, 0.1dB Flatness >100MHz
LT1399	300MHz Triple Current Feedback Amplifier	0.1dB Gain Flatness to 150MHz, Shutdown
LT1675/LT1675-1	Triple/Single 2:1 Buffered Video Multiplexer	2.5ns Switching Time, 250MHz Bandwidth
LT1806/LT1807	Single/Dual 325MHz Rail-to-Rail In/Out Op Amp	Low Distortion, Low Noise
LT1809/LT1810	Single/Dual 180MHz Rail-to-Rail In/Out Op Amp	Low Distortion, Low Noise
LT6550/LT6551	3.3V Triple and Quad Video Buffers	110MHz Gain of 2 Buffers in MS Package
LT6553	650MHz Gain of 2 Triple Video Amplifier	
LT6554	650MHz Gain of 1 Triple Video Amplifier	Same Pinout as the LT6553 but Optimized for High Impedance Loads
LT6555	650MHz Gain of 2 Triple 2:1 Video Multiplexor	
LT6556	750MHz Gain of 1 Triple 2:1 Video Multiplexor	Same Pinout as the LT6553 but Optimized for High Impedance Loads
LT6557	500MHz Gain of 2 Single-Supply Triple Video Amplifier	Optimized for Single 5V Supply, 2200V/μs Slew Rate, Input Bias Control
LT6558	550MHz Gain of 1 Single-Supply Triple Video Amplifier	Optimized for Single 5V Supply, 2200V/μs Slew Rate, Input Bias Control