



Product Description: T315XW02 TFT-LCD PANEL with RoHS guarantee			
-----			
AUO Model Name: T315XW02 VL			
Customer Part No/Project Name:			
Customer Signature	Date	AUO	Date
		Approved By:	
		Reviewed By:	
		Prepared By: CT Wu	



**Document Version : 0.2**

**Date : 2007/10/24**

## **Product Specifications**

**31.5" WXGA Color TFT-LCD Module  
Model Name: T315XW02 VL**

**(\*) Preliminary Specifications  
( ) Final Specifications**

## Contents

No	
	COVER
	CONTENTS
	RECORD OF REVISIONS
1	GENERAL DESCRIPTION
2	ABSOLUTE MAXIMUM RATINGS
3	ELECTRICAL SPECIFICATIONS
3-1	ELECTRICAL CHARACTERISTICS
3-2	INTERFACE CONNECTIONS
3-3	SIGNAL TIMING SPECIFICATIONS
3-4	SIGNAL TIMING WAVEFORMS
3-5	COLOR INPUT DATA REFERENCE
3-6	POWER SEQUENCE
4	OPTICAL SPECIFICATIONS
5	MECHANICAL CHARACTERISTICS
6	RELIABILITY
7	INTERNATIONAL STANDARDS
7-1	SAFETY
7-2	EMC
8	PACKING
9	PRECAUTIONS



## 1. General Description

This specification applies to the 31.51 inch Color TFT-LCD Module T315XW02 VL. This LCD module has a TFT active matrix type liquid crystal panel 1366x768 pixels, and diagonal size of 31.51 inch. This module supports 1366x768 XGA-WIDE mode (Non-interlace). Each pixel is divided into Red, Green and Blue sub-pixels or dots which are arranged in vertical stripes. Gray scale or the brightness of the sub-pixel color is determined with a 8-bit gray scale signal for each dot.

The T315XW02 VL has been designed to apply the 8-bit 1 channel LVDS interface method. It is intended to support displays where high brightness, wide viewing angle, high color saturation, and high color depth are very important.

The T315XW02 VL model is RoHS verified, which can be distinguished on panel label.

### \* General Information

Items	Specification	Unit	Note
Active Screen Size	31.51 inches		
Display Area	697.685 (H) x 392.256(V)	mm	
Outline Dimension	760.0(H) x 450.0(V) x 45(D)	mm	With inverter
Driver Element	a-Si TFT active matrix		
Display Colors	16.7M	Colors	
Number of Pixels	1366 x 768	Pixel	
Pixel Pitch	0.51075	mm	
Pixel Arrangement	RGB vertical stripe		
Display Mode	Normally Black		
Surface Treatment	AG, 3H		

## 2. Absolute Maximum Ratings

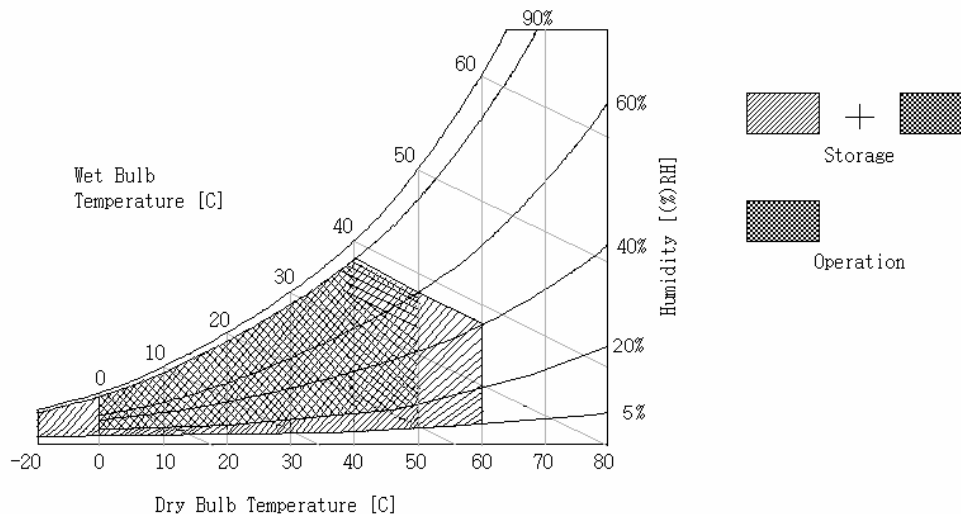
The following are maximum values which, if exceeded, may cause permanent damage to the unit.

Item	Symbol	Min	Max	Unit	Conditions
Logic/LCD Drive Voltage	Vcc	-0.3	14	[Volt]	Note 1
Input Voltage of Signal	Vin	-0.3	3.6	[Volt]	Note 1
BLU Input Voltage	VDDDB	-0.3	28	[Volt]	Note 1
BLU Brightness Control Voltage	Vdim	-0.3	7.0	[Volt]	Note 1
Operating Temperature	TOP	0	+50	[°C]	Note 2
Operating Humidity	HOP	10	90	[%RH]	Note 2
Storage Temperature	TST	-20	+60	[°C]	Note 2
Storage Humidity	HST	10	90	[%RH]	Note 2
Panel Surface Temperature	PST		65	[°C]	

Note 1: Duration:50 msec.

Note 2 : Maximum Wet-Bulb should be 39°C and No condensation.

The relative humidity must not exceed 90% non-condensing at temperatures of 40°C or less. At temperatures greater than 40°C, the wet bulb temperature must not exceed 39°C.



### 3. Electrical Specification

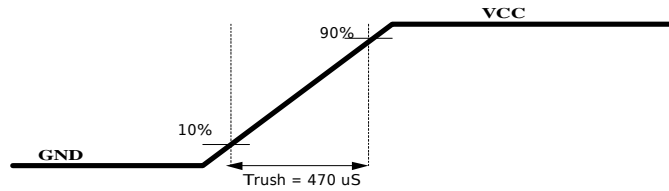
The T315XW02 VL requires two power inputs. One is employed to power the LCD electronics and to drive the TFT array and liquid crystal. The second input power for the BLU, is to power inverter..

#### 3-1 Electrical Characteristics

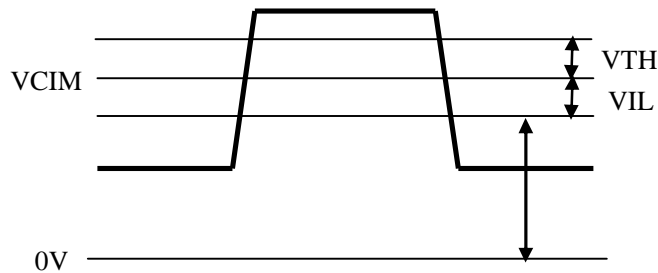
Parameter			Values			Unit	Notes
			Min	Typ	Max		
LCD:							
Power Supply Input Voltage		V <sub>CC</sub>	10.8	12	13.2	Vdc	1
Power Supply Input Current		I <sub>CC</sub>	-	0.55	0.65	A	2
Power Consumption		P <sub>C</sub>	-	6.6	7.5	Watt	2
Inrush Current		I <sub>RUSH</sub>	-	-	6	A <sub>peak</sub>	3
LVDS Interface	Differential Input High Threshold Voltage	V <sub>TH</sub>	100			mV	4
	Differential Input Low Threshold Voltage	V <sub>TL</sub>	100			mV	4
	Common Input Voltage	V <sub>CIM</sub>	1.10	1.25	1.40	V	4
CMOS Interface	Input High Threshold Voltage	V <sub>IH</sub> (High)	2.4		3.3	Vdc	
	Input Low Threshold Voltage	V <sub>IL</sub> (Low)	0		0.7	Vdc	
Backlight Power Consumption		P <sub>DDb</sub>	87.4	92	96.6	Watt	8
Life Time			50,000			Hours	9

**Note :**

1. The ripple voltage should be controlled under 10% of V<sub>CC</sub>
2. V<sub>CC</sub>=12.0V,  $f_v = 60\text{Hz}$ ,  $f_{\text{CLK}}=81.5\text{Mhz}$ , 25°C, Test Pattern : White Pattern
3. Measurement condition :



4.  $V_{CIM} = 1.2V$



5. The performance of the Lamp in LCM, for example life time or brightness, is extremely influenced by the characteristics of the DC-AC Inverter. So all the parameters of an inverter should be carefully designed so as not to produce too much leakage current from high-voltage output of the inverter. When you design or order the inverter, please make sure unwanted lighting caused by the mismatch of the lamp and the inverter (no lighting, flicker, etc) never occurs. When you confirm it, the LCD Assembly should be operated in the same condition as installed in your instrument.
6. Do not attach a conducting tape to lamp connecting wire. If the lamp wire attach to conducting tape, TFT-LCD Module have a low luminance and the inverter has abnormal action because leakage current occurs between lamp wire and conducting tape.
7. The relative humidity must not exceed 80% non-condensing at temperatures of 40°C or less. At temperatures greater than 40°C, the wet bulb temperature must not exceed 39°C. When operate at low temperatures, the brightness of CCFL will drop and the life time of CCFL will be reduced.
8. The measured data is without boost function
9. W/O boost function Lifetime is defined and judged for lamp when analog and PWM dimming are maximum values. With boost function Lifetime is defined and judged for lamp when boost function is high (3.3V).



### 3-2 Interface Connections

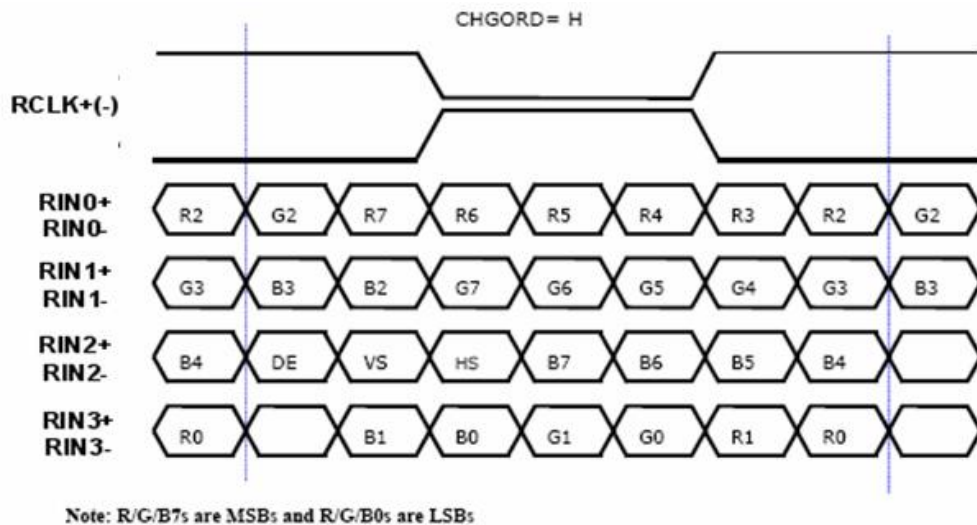
- Connector on Panel: **FI-X30SSL-HF** (Manufactured by JAE) or Equivalent
- Mating connector: FI-30C2L (Manufactured by JAE) or Equivalent

Pin No	Symbol	Description	Default
1	VCC	+12V, DC, Regulated	
2	VCC	+12V, DC, Regulated	
3	VCC	+12V, DC, Regulated	
4	VCC	+12V, DC, Regulated	
5	GND	Ground and Signal Return	
6	GND	Ground and Signal Return	
7	GND	Ground and Signal Return	
8	GND	Ground and Signal Return	
9	LVDS Option	Low/Open for Normal (NS), High for JEIDA	NS mode
10	Reserved	Open	AUO internal test
11	GND	Ground and Signal Return for LVDS	
12	RIN0-	LVDS Channel 0 negative	
13	RIN0+	LVDS Channel 0 positive	
14	GND	Ground and Signal Return for LVDS	
15	RIN1-	LVDS Channel 1 negative	
16	RIN1+	LVDS Channel 1 positive	
17	GND	Ground and Signal Return for LVDS	
18	RIN2-	LVDS Channel 2 negative	
19	RIN2+	LVDS Channel 2 positive	
20	GND	Ground and Signal Return for LVDS	
21	RCLK-	LVDS Clock negative	
22	RCLK+	LVDS Clock positive	
23	GND	Ground and Signal Return for LVDS	
24	RIN3-	LVDS Channel 3 negative	
25	RIN3+	LVDS Channel 3 positive	
26	GND	Ground and Signal Return for LVDS	
27	Reserved	Open or High	AUO internal test
28	Reserved	Open or High	AUO internal test
29	GND	Ground and Signal Return	
30	GND	Ground and Signal Return	

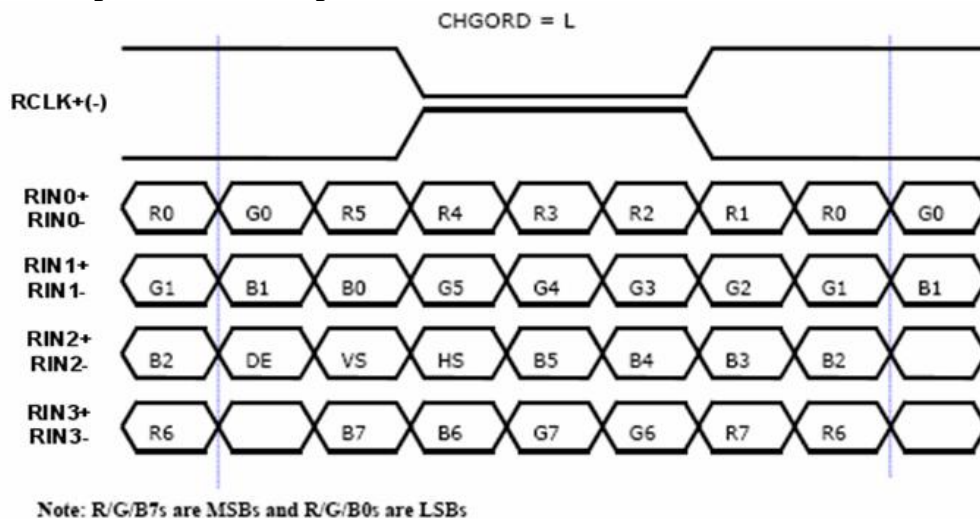
**Note:**

1. All GND (ground) pins should be connected together and should also be connected to the LCD's metal frame. All Vcc (power input) pins should be connected together.
2. For Pin 10, 27 and 28, panel will not damage if negligently connect these pins to high or low

### LVDS Option = High



### LVDS Option = Low or Open



## BACKLIGHT CONNECTOR PIN CONFIGURATION -

### 1. Electrical specification

Item	Symb.	Condition	Spec			Unit	Note
			Min	Typ	Max		
Input Voltage	VDDB	---	21.6	24.0	26.4	VDC	
Input Current	IDDB	VDDB=24V	3.64	3.83	4.03	ADC	1
Input Power	PDDB	VDDB=24V	87.4	92.0	96.6	W	1
Inrush Current	IRUSH	VDDB=24V	---	---	5.0	ADC	1,2
On/Off Control Voltage	VBLON	ON	VDDB=24V	2.0	---	5.0	VDC
		OFF	VDDB=24V	0.0	---	0.8	
On/Off Control Current	IBLON	VDDB=24V	0.0	---	1.5	mADC	
Dimming Control Voltage	VDIM	MAX	VDDB=24V	---	3.3	---	VDC
		MIN	VDDB=24V	---	0.0	---	
PWM Function	V_PWM	MAX	---	2.0	---	5.0	VDC
		MIN	---	0.0	---	0.8	
External PWM Control Current	I_EPWM	---	---	---	1.5	mADC	
External PWM Duty Ratio	D_EPWM	---	20	---	100	%	
External PWM Frequency	F_EPWM	---	120	180	300	Hz	

Note1 : VDIM= 3.3V (MAX)

( Ta=25±5°C , Turn on for 45minutes )

Note 2 : Measurement condition Rising time = 20 ms (VDDB : 10%~90%);

### 2. Input specification

CN1: JST PHR-14 or equivalent

No	Symbol	Description
1	VDDB (Main Power)	DC input 24.0 VDC
2	VDDB (Main Power)	DC input 24.0 VDC
3	VDDB (Main Power)	DC input 24.0 VDC
4	VDDB (Main Power)	DC input 24.0 VDC
5	VDDB (Main Power)	DC input 24.0 VDC
6	GND	Ground
7	GND	Ground
8	GND	Ground
9	GND	Ground
10	GND	Ground
11	Reserved	Please leave it open
12	VBLON (Enable Pin)	On/Off control Signal; High/Open: On; Low: Off
13	VDIM/PDIM (LCD Bright)	VDIM: Internal PWM Dimming control signal input (DC 0~3.3V) PDIM: External PWM Dimming control signal input (AC 0~3.3V, Duty: 20%~100%) (3.3V : Maximum brightness, 0V min brightness)
14	VDIM/PDIM Selection	VDIM: High/Open PDIM: GND

### 3-3 Signal Timing Specifications

This is the signal timing required at the input of the User connector. All of the interface signal timing should be satisfied with the following specifications for its proper operation.

\* Timing Table

DE only Mode

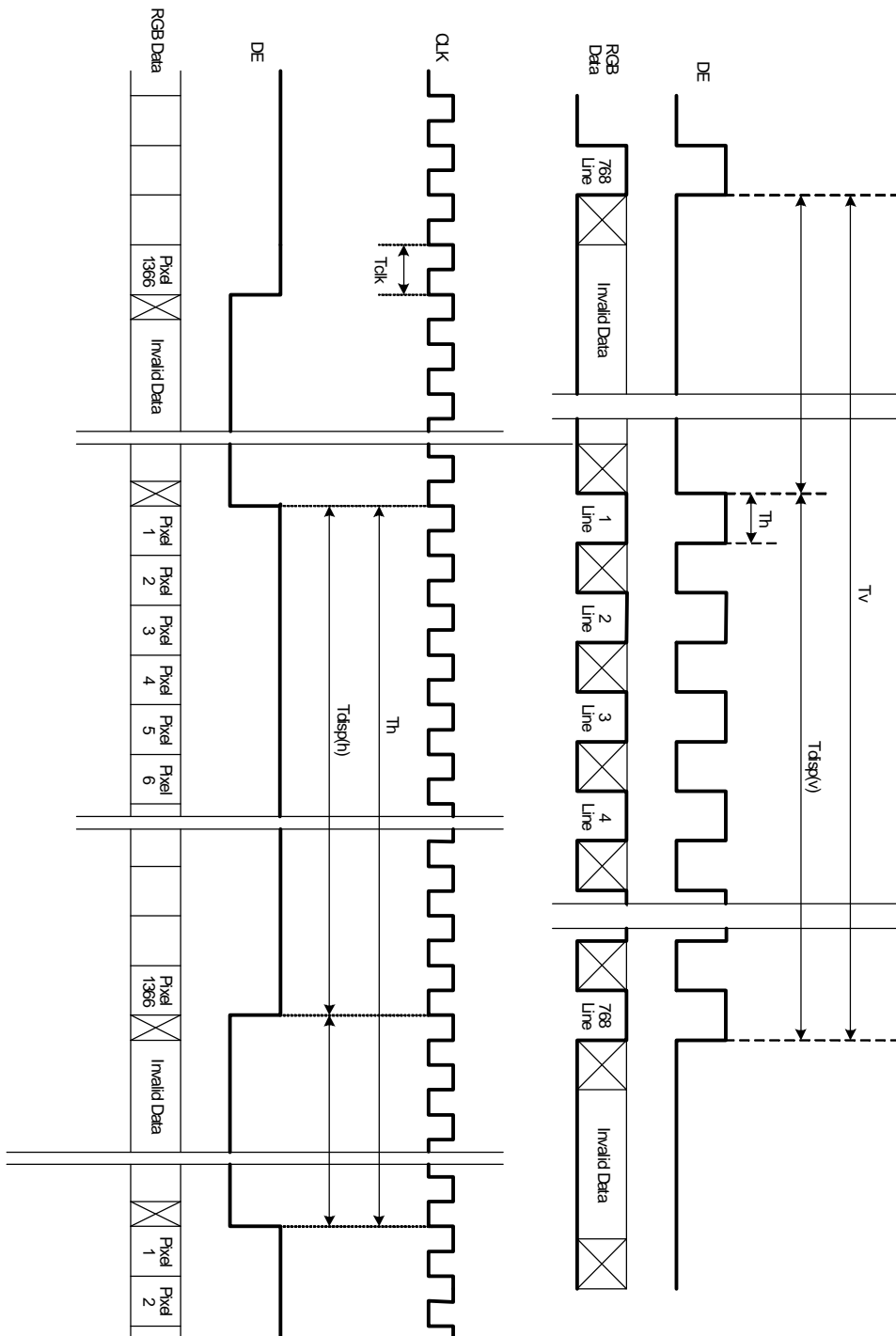
Vertical Frequency:

Signal	Item	Symbol	Min.	Typ.	Max.	Unit	Notes
Vertical Section	Period	Tv	784	806	1015	Th	
	Active	Tdisp(v)	768			Th	
	Blanking	Tblk(v)	16	38	247	Th	
Horizontal Section	Period	Th	1440	1560	1900	Tclk	
	Active	Tdisp(h)	1366			Tclk	
	Blanking	Tblk(h)	48	194	534	Tclk	
LVDS Clock	Frequency	Fclk (1/Tclk)	60	80	85	MHz	
Vertical Frequency	Frequency	Fv	47	60	63	Hz	
Horizontal Frequency	Frequency	Fh	43	48	53	kHz	

Notes:

- 1.) Display position is specific by the rise of DE signal only.  
Horizontal display position is specified by the rising edge of 1<sup>st</sup> DCLK after the rise of 1<sup>st</sup> DE, is displayed on the left edge of the screen.  
Vertical display position is specified by the rise of DE after a “Low” level period equivalent to eight times of horizontal period. The 1<sup>st</sup> data corresponding to one horizontal line after the rise the of 1<sup>st</sup> DE is displayed at the top line of screen.
- 3.) If a period of DE “High” is less than 1366 DCLK or less than 768 lines, the rest of the screen displays black.
- 4.) The display position does not fit to the screen if a period of DE “High” and the effective data period do not synchronize with each other.

### 3-4 Signal Timing Waveforms





### 3-5 Color Input Data Reference

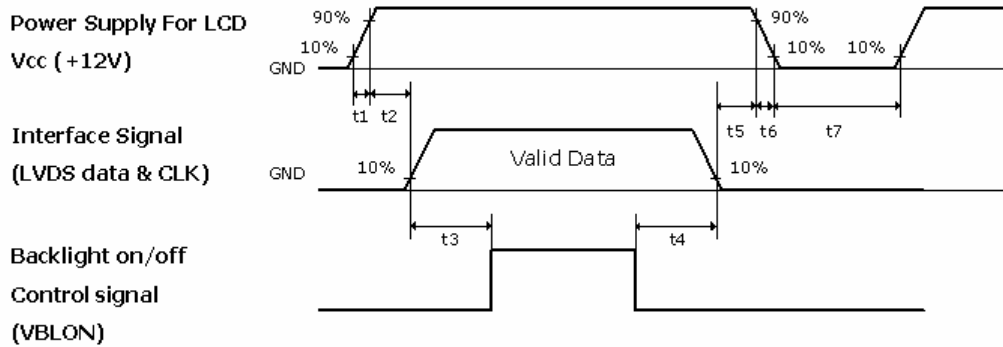
The brightness of each primary color (red, green and blue) is based on the 8 bit gray scale data input for the color; the higher the binary input, the brighter the color. The table below provides a reference for color versus data input.

COLOR DATA REFERENCE

Color		Input Color Data																							
		RED								GREEN								BLUE							
		MSB				LSB				MSB				LSB				MSB				LSB			
		R7	R6	R5	R4	R3	R2	R1	R0	G7	G6	G5	G4	G3	G2	G1	G0	B7	B6	B5	B4	B3	B2	B1	B0
Basic Color	Black	0	0	0	0	0	0	0	0	0	0	0	0	0	0	0	0	0	0	0	0	0	0	0	0
	Red(255)	1	1	1	1	1	1	1	1	0	0	0	0	0	0	0	0	0	0	0	0	0	0	0	0
	Green(255)	0	0	0	0	0	0	0	0	1	1	1	1	1	1	1	1	0	0	0	0	0	0	0	0
	Blue(255)	0	0	0	0	0	0	0	0	0	0	0	0	0	0	0	0	1	1	1	1	1	1	1	1
	Cyan	0	0	0	0	0	0	0	0	1	1	1	1	1	1	1	1	1	1	1	1	1	1	1	1
	Magenta	1	1	1	1	1	1	1	1	0	0	0	0	0	0	0	0	1	1	1	1	1	1	1	1
	Yellow	1	1	1	1	1	1	1	1	1	1	1	1	1	1	1	1	0	0	0	0	0	0	0	0
White	1	1	1	1	1	1	1	1	1	1	1	1	1	1	1	1	1	1	1	1	1	1	1	1	
RED	RED(000)	0	0	0	0	0	0	0	0	0	0	0	0	0	0	0	0	0	0	0	0	0	0	0	0
	RED(001)	0	0	0	0	0	0	0	1	0	0	0	0	0	0	0	0	0	0	0	0	0	0	0	0
	----																								
	RED(254)	1	1	1	1	1	1	1	0	0	0	0	0	0	0	0	0	0	0	0	0	0	0	0	0
	RED(255)	1	1	1	1	1	1	1	1	0	0	0	0	0	0	0	0	0	0	0	0	0	0	0	0
GREEN	GREEN(000)	0	0	0	0	0	0	0	0	0	0	0	0	0	0	0	0	0	0	0	0	0	0	0	0
	GREEN(001)	0	0	0	0	0	0	0	0	0	0	0	0	0	0	0	1	0	0	0	0	0	0	0	0
	----																								
	GREEN(254)	0	0	0	0	0	0	0	0	1	1	1	1	1	1	1	0	0	0	0	0	0	0	0	0
	GREEN(255)	0	0	0	0	0	0	0	0	1	1	1	1	1	1	1	1	0	0	0	0	0	0	0	0
BLUE	BLUE(000)	0	0	0	0	0	0	0	0	0	0	0	0	0	0	0	0	0	0	0	0	0	0	0	0
	BLUE(001)	0	0	0	0	0	0	0	0	0	0	0	0	0	0	0	0	0	0	0	0	0	0	0	1
	-----																								
	BLUE(254)	0	0	0	0	0	0	0	0	0	0	0	0	0	0	0	0	1	1	1	1	1	1	1	0
	BLUE(255)	0	0	0	0	0	0	0	0	0	0	0	0	0	0	0	0	1	1	1	1	1	1	1	1

### 3-6 Power Sequence for LCD Module

#### 3.6.1 Power Sequence for LCD



Parameter	Values			Units
	Min.	Typ.	Max.	
t1	0.4	-	30	ms
t2	0.1	-	50	ms
t3	200	-	-	ms
t4	10	-	-	ms
t5	0.1	-	50	ms
t6		-	300	ms
t7	300	-	-	ms

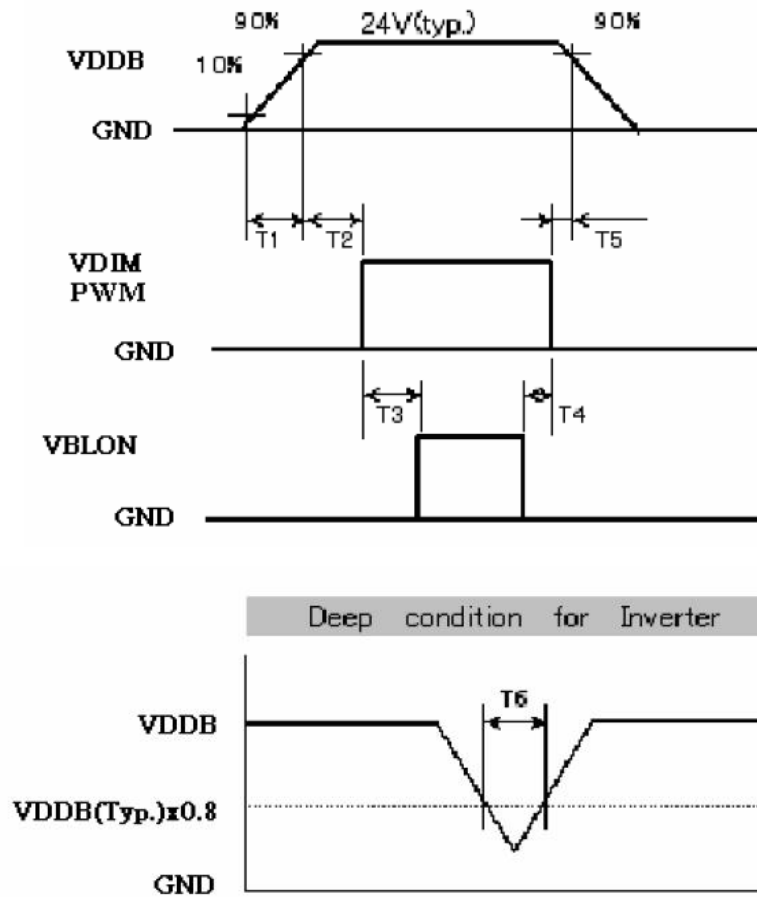
**Note:**

The timing controller will not be damaged in case of TV set AC input power suddenly shut down.

Once power reset, it should follow power sequence as spec. definition.

- (1) Apply the lamp voltage within the LCD operation range. When the back-light turns on before the LCD operation or the LCD turns off before the back-light turns off, the display may momentarily become abnormal screen.

### 3.6.2 Power Sequence for Inverter



Parameter	Values			Units
	Min.	Typ.	Max.	
T1	20	-	-	ms
T2	50	-	-	ms
T3	0	-	-	ms
T4	0	-	-	ms
T5	0	-	-	ms
T6	-	-	10	ms

**Note:**

In case of  $t_3=200\text{ms}$ , uniformity and optical performance are not guaranteed. But it will not damage power supplier and inverter.

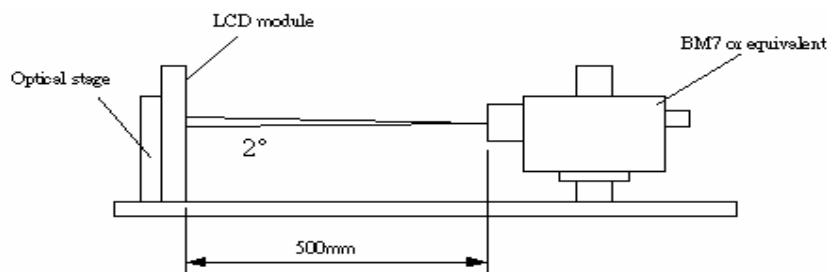
In case of  $t_7=1000\text{ms}$ , inverter operation is guaranteed. But brightness control depends on lamp response time.



## 4. Optical Specification

Optical characteristics are determined after the unit has been 'ON' and stable for approximately 45 minutes in a dark environment at 25°C. The values specified are at an approximate distance 50cm from the LCD surface at a viewing angle of  $\Phi$  and  $\theta$  equal to 0°.

**Fig.1 1 presents additional information concerning the measurement equipment and method.**



Parameter	Symbol	Values			Units	Notes
		Min.	Typ.	Max.		
Contrast Ratio	CR	1200	2000			1
Surface Luminance, white	LWH	400	450		cd/m <sup>2</sup>	2
Luminance Variation	$\delta_{\text{WHITE}}$   9 p			1.30		3
Response time	Ton / Toff	Ton & Toff	15/5	17/8	ms	4
	Gray to Gray	T $\gamma$	6.5	8	ms	5
Color Gamut	NTSC		72		%	
Color Coordinates						
	RED	R <sub>X</sub>		0.64		
		R <sub>Y</sub>		0.33		
	GREEN	G <sub>X</sub>	Typ.-0.03	0.28	Typ.+0.03	
		G <sub>Y</sub>		0.60		
	BLUE	B <sub>X</sub>		0.15		
		B <sub>Y</sub>		0.05		
	WHITE	W <sub>X</sub>		0.28		
		W <sub>Y</sub>		0.29		
Viewing Angle						
	x axis, right( $\varphi=0^\circ$ )	$\theta_r$		89	Degree	6
	x axis, left( $\varphi=180^\circ$ )	$\theta_l$		89		
	y axis, up( $\varphi=90^\circ$ )	$\theta_u$		89		
	y axis, down ( $\varphi=0^\circ$ )	$\theta_d$		89		

**Note:**

1. Contrast Ratio (CR) is defined mathematically as:

$$\text{Contrast Ratio} = \frac{\text{Surface Luminance of } L_{on1}}{\text{Surface Luminance of } L_{off1}}$$

2. Surface luminance is luminance value at point 1 across the LCD surface 50cm from the surface with all pixels displaying white. From more information see FIG 2. When  $V_{DDB} = 24V$ ,  $I_{DDB} = 5A$ .  $L_{WH} = L_{on1}$

Where  $L_{on1}$  is the luminance with all pixels displaying white at center 1 location.

3. The variation in surface luminance,  $\delta_{WHITE}$  is defined (center of Screen) as:

$$\delta_{WHITE(9P)} = \frac{\text{Maximum}(L_{on1}, L_{on2}, \dots, L_{on9})}{\text{Minimum}(L_{on1}, L_{on2}, \dots, L_{on9})}$$

4. Response time is the time required for the display to transition from black to white ( $T_{on}$ ) and from white to black ( $T_{off}$ ). For additional information see FIG3.

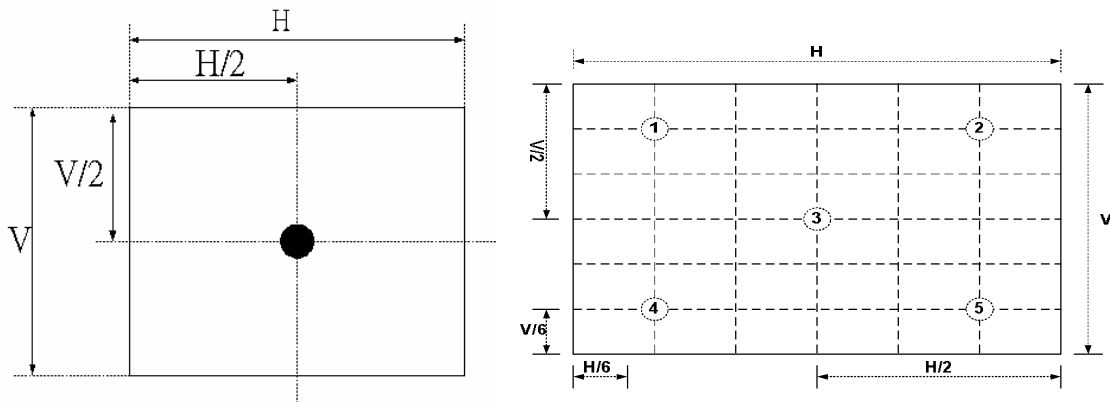
5. Response time  $T_{\gamma}$  is the average time required for display transition by switching the input signal for five luminance ratio (0%,25%,50%,75%,100% brightness matrix) and is based on  $f_v = 60\text{Hz}$  to optimize.

	0%	25%	50%	75%	100%
0%		t:0%-25%	t:0%-50%	t:0%-75%	t:0%-100%
25%	t:25%-0%		t:25%-50%	t:25%-75%	t:25%-100%
50%	t:50%-0%	t:50%-25%		t:50%-75%	t:50%-100%
75%	t:75%-0%	t:75%-25%	t:75%-50%		t:75%-100%
100%	t:100%-0%	t:100%-25%	t:100%-50%	t:100%-75%	

6. Viewing angle is the angle at which the contrast ratio is greater than 10. The angles are determined for the horizontal or x axis and the vertical or y axis with respect to the z axis which is normal to the LCD surface.

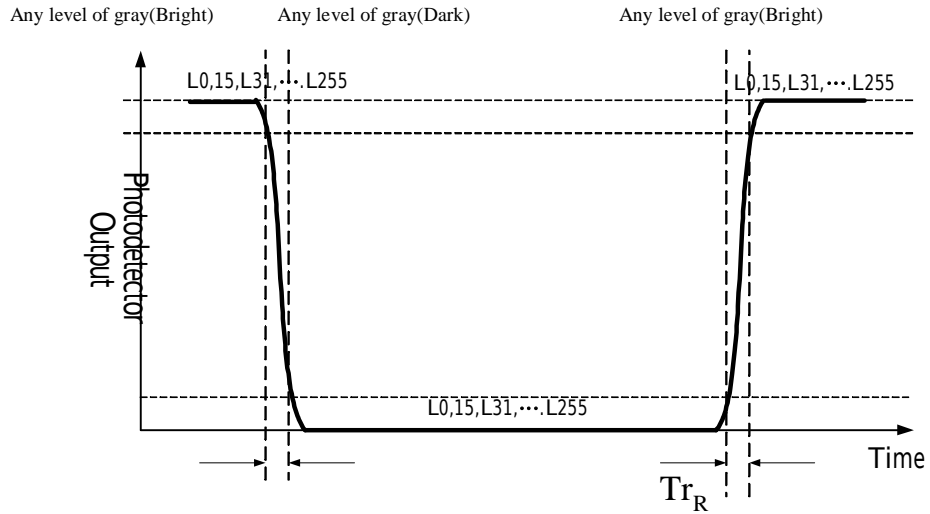
For more information see FIG4.

**FIG. 2 Luminance**

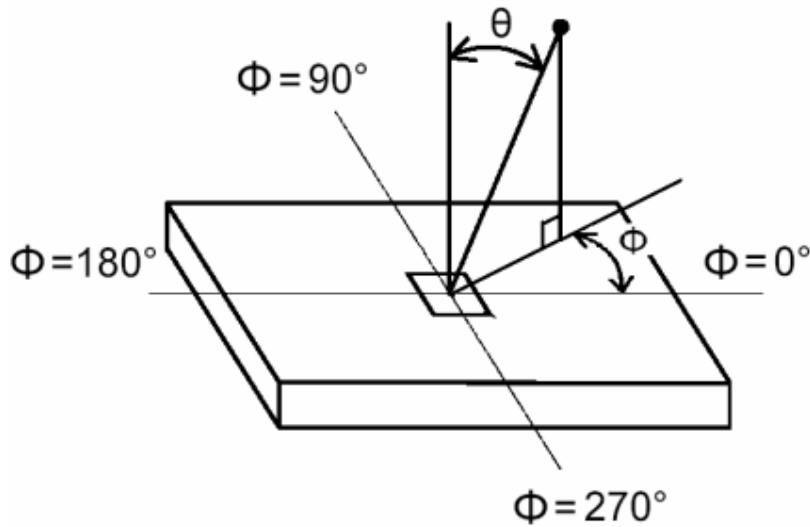


**FIG.3 Response Time**

The response time is defined as the following figure and shall be measured by switching the input signal for “any level of gray(bright)” and “any level of gray(dark)”.



**FIG.4 Viewing angle**



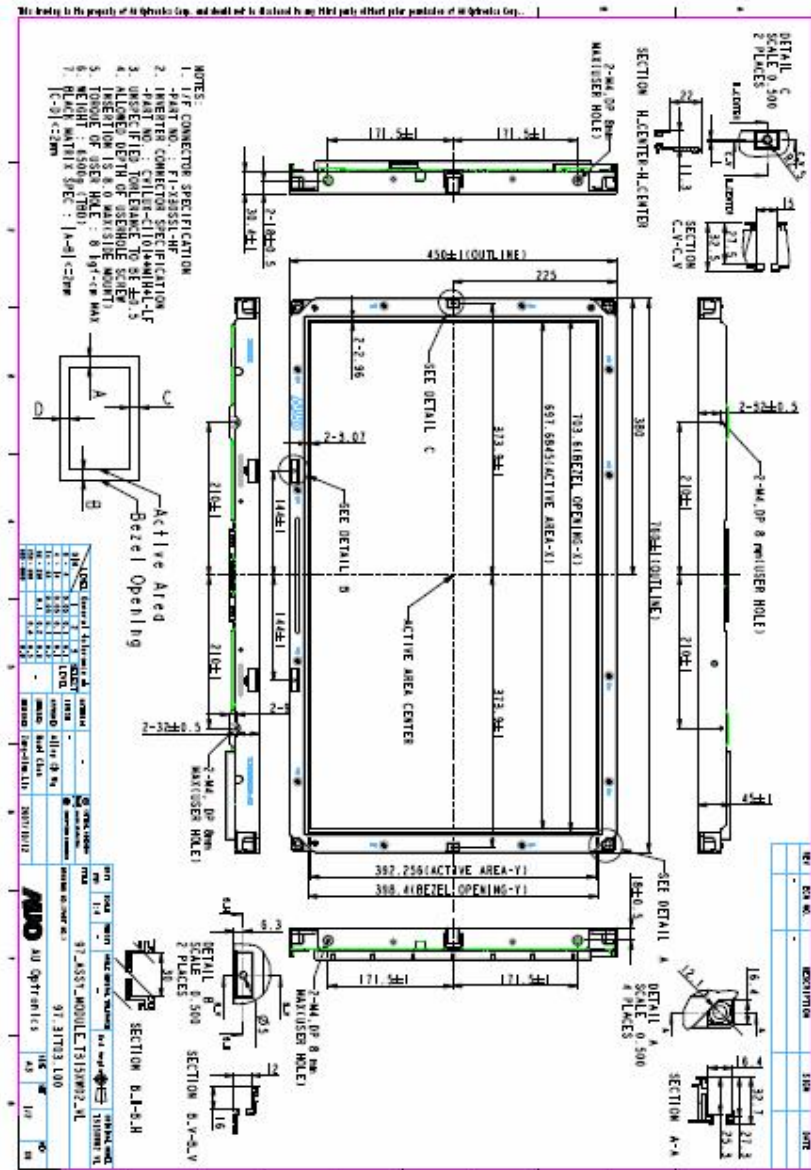


## 5. Mechanical Characteristics

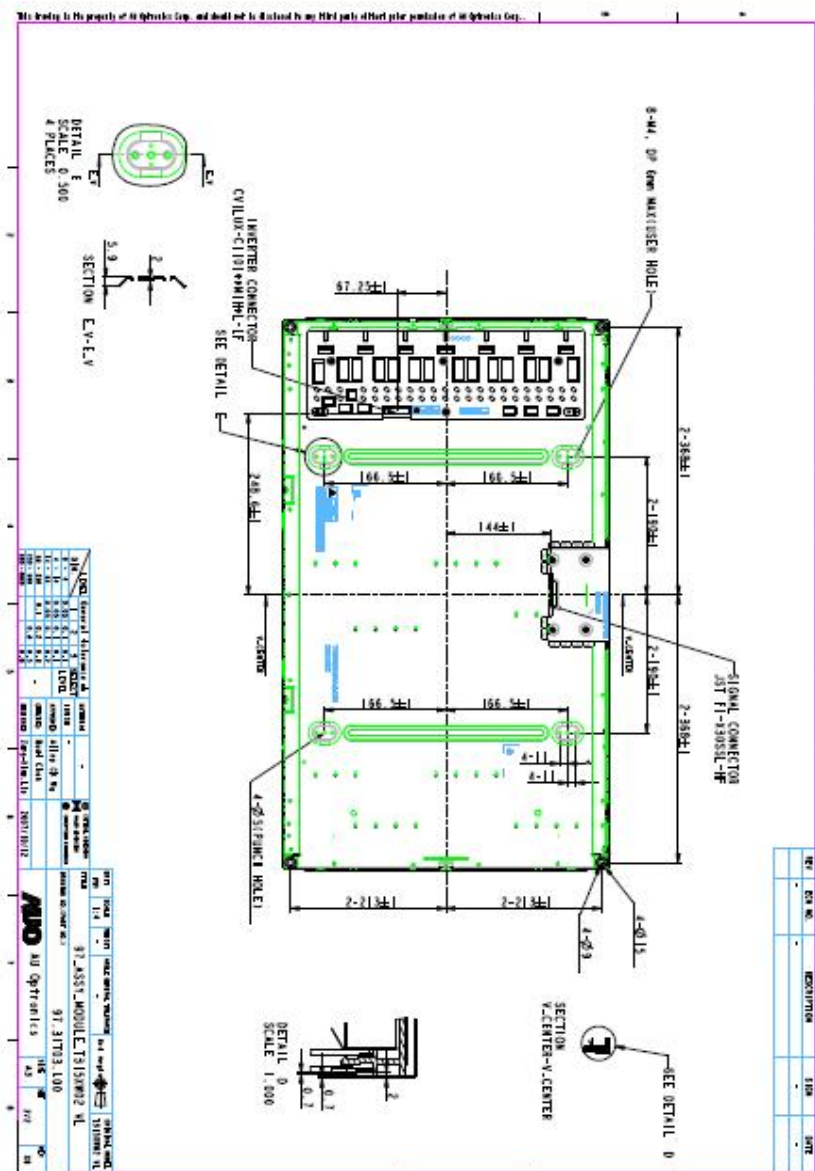
The contents provide general mechanical characteristics for the model T315XW02 VL. In addition the figures in the next page are detailed mechanical drawing of the LCD.

Outline Dimension	Horizontal	760.0mm
	Vertical	450.0mm
	Depth	45mm
Bezel Opening	Horizontal	703.6mm
	Vertical	398.3mm
Active Display Area	Horizontal	697.68mm
	Vertical	392.26mm
Weight	6500g Typ.	
Surface Treatment	AG, 3H	

**Front:**



Back:



## 6. Reliability:

Environment test condition

No	Test Item	Condition
1	High temperature storage test	Ta=60°C 300h
2	Low temperature storage test	Ta=-20°C 300h
3	High temperature operation test	Ta=50°C 300h
4	Low temperature operation test	Ta=-5°C 300h
5	Thermal Humidity Bias Test	Ta=50°C 80%RH 300h
6	Thermal Shock Test	Ta=-20°C/0.5h~60°C/0.5h , 500cycles
7	Vibration test (non-operating)	Wave form: random Vibration level : 1.0G RMS Bandwidth : 10-500Hz Duration: X, Y, Z 20min, one time each direction
8	Shock test (non-operating)	Shock level: 50G Waveform: half sine wave, 11ms Direction: ±X, ±Y, ±Z, one time each direction
9	Vibration test (with carton)	Random wave Vibration:10~200Hz,1.5Grms,30minutes Direction: ±X, ±Y, ±Z, one time each direction
10	Drop test (with carton)	Height: 46cm 1 corner, 3 edges, 6 surfaces (ASTMD4169-I)

## 7. International Standard

### 7-1. Safety

- (1) UL1950 Third Edition, Underwriters Laboratories, Inc. Jan. 28, 1995  
Standard for Safety of Information Technology Equipment Including electrical Business Equipment.
- (2) CAN/CSA C22.2 No. 950-95/60950 Third Edition, Canadian Standards Association,  
Standard for Safety of Information Technology Equipment Including Electrical Business Equipment.
- (3) EN60950 : 1992+A2: 1993+A2: 1993+C3: 1995+A4: 1997+A11: 1997  
IEC 950: 1991+A1: 1992+A2: 1993+C3: 1995+A4:1996  
European Committee for Electrotechnical Standardization (CENELEC)  
EUROPEAN STANDARD for Safety of Information Technology Equipment Including Electrical  
Business Equipment.

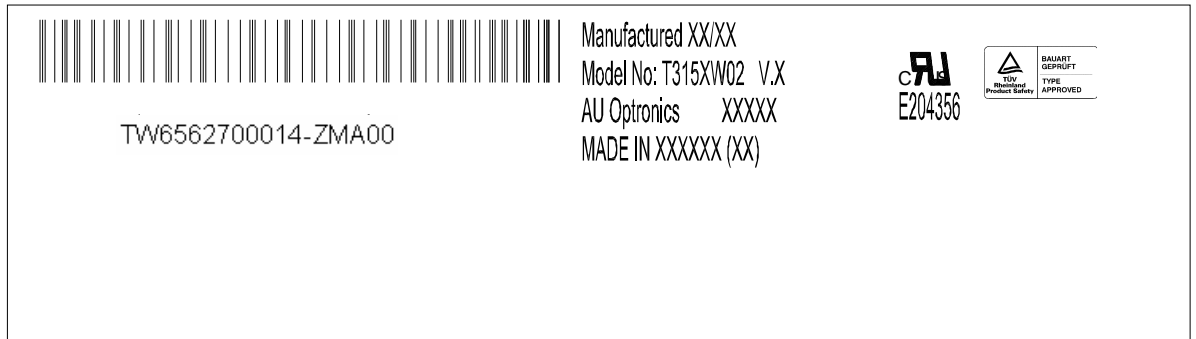
### 7-2. EMC

- a) ANSI C63.4 “Methods of Measurement of Radio-Noise Emissions from Low-Voltage Electrical and Electrical Equipment in the Range of 9kHz to 40GHz. “American National standards Institute(ANSI), 1992
- b) C.I.S.P.R “Limits and Methods of Measurement of Radio Interface Characteristics of Information Technology Equipment.” International Special committee on Radio Interference.
- c) EN 55022 “Limits and Methods of Measurement of Radio Interface Characteristics of Information Technology Equipment.” European Committee for Electrotechnical Standardization. (CENELEC), 1998



## 8. Packing

Panel label:



### TW6562700014

TW65627: T: Taiwan, A/B: China

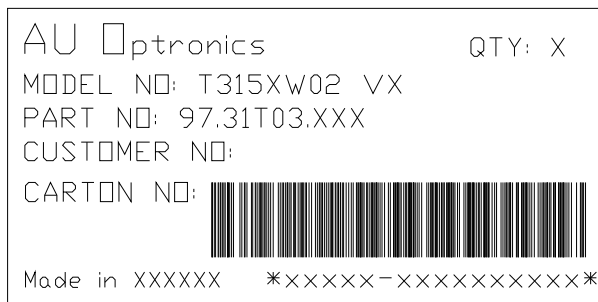
00014: Panel Serial Number

ZMA: AUO internal code

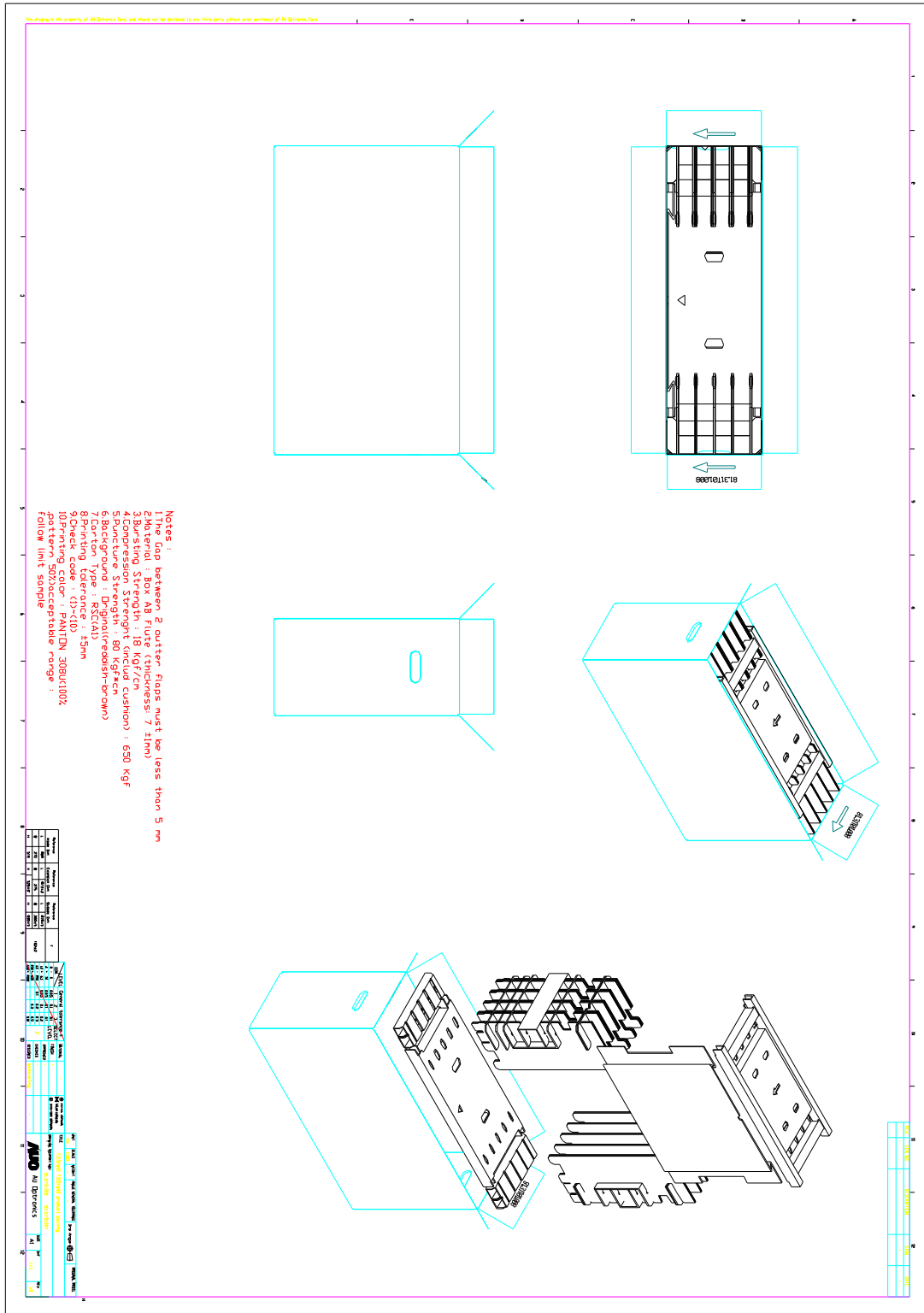
Manufactured 06/23: 2006 week 23

Made In Taiwan: Taiwan made

Carton Label:



Carton:



## 9. PRECAUTIONS

Please pay attention to the followings when you use this TFT LCD module.

### 9-1 MOUNTING PRECAUTIONS

- (1) You must mount a module using holes arranged in four corners or four sides.
- (2) You should consider the mounting structure so that uneven force (ex. Twisted stress) is not applied to module. And the case on which a module is mounted should have sufficient strength so that external force is not transmitted directly to the module.
- (3) Please attach the surface transparent protective plate to the surface in order to protect the polarizer. Transparent protective plate should have sufficient strength in order to resist external force.
- (4) You should adopt radiation structure to satisfy the temperature specification.
- (5) Acetic acid type and chlorine type materials for the cover case are not desirable because the former generates corrosive gas of attacking the polarizer at high temperature and the latter causes circuit break by electro-chemical reaction.
- (6) Do not touch, push or rub the exposed polarizers with glass, tweezers or anything harder than HB pencil lead. And please do not rub with dust clothes with chemical treatment. Do not touch the surface of polarizer for bare hand or greasy cloth. (Some cosmetics are detrimental to the polarizer.)
- (7) When the surface becomes dusty, please wipe gently with absorbent cotton or other soft materials like chamois soaks with petroleum benzene. Normal-hexane is recommended for cleaning the adhesives used to attach front/ rear polarizers. Do not use acetone, toluene and alcohol because they cause chemical damage to the polarizer.
- (8) Wipe off saliva or water drops as soon as possible. Their long time contact with polarizer causes deformations and color fading.
- (9) Do not open the case because inside circuits do not have sufficient strength.

### 9-2 OPERATING PRECAUTIONS

- (1) The spike noise causes the mis-operation of circuits. It should be lower than following voltage:  
 $V = \pm 200\text{mV}$  (Over and under shoot voltage)
- (2) Response time depends on the temperature. (In lower temperature, it becomes longer.)
- (3) Brightness depends on the temperature. (In lower temperature, it becomes lower.) And in lower temperature, response time (required time that brightness is stable after turned on) becomes longer.
- (4) Be careful for condensation at sudden temperature change. Condensation makes damage to polarizer or electrical contacted parts. And after fading condensation, smear or spot will occur.
- (5) When fixed patterns are displayed for a long time, remnant image is likely to occur.
- (6) Module has high frequency circuits. Sufficient suppression to the electromagnetic interference shall be done by system manufacturers. Grounding and shielding methods may be important to minimize the interface.

### **9-3 ELECTROSTATIC DISCHARGE CONTROL**

Since a module is composed of electronic circuits, it is not strong to electrostatic discharge. Make certain that treatment persons are connected to ground through wrist band etc. And don't touch interface pin directly.

### **9-4 PRECAUTIONS FOR STRONG LIGHT EXPOSURE**

Strong light exposure causes degradation of polarizer and color filter.

### **9-5 STORAGE +**

When storing modules as spares for a long time, the following precautions are necessary.

- (1) Store them in a dark place. Do not expose the module to sunlight or fluorescent light. Keep the temperature between 5°C and 35°C at normal humidity.
- (2) The polarizer surface should not come in contact with any other object. It is recommended that they be stored in the container in which they were shipped.

### **9-6 HANDLING PRECAUTIONS FOR PROTECTION FILM**

- (1) The protection film is attached to the bezel with a small masking tape. When the protection film is peeled off, static electricity is generated between the film and polarizer. This should be peeled off slowly and carefully by people who are electrically grounded and with well ion-blown equipment or in such a condition, etc.
- (2) When the module with protection film attached is stored for a long time, sometimes there remains a very small amount of glue still on the Bezel after the protection film is peeled off.
- (3) You can remove the glue easily. When the glue remains on the Bezel or its vestige is recognized, please wipe them off with absorbent cotton waste or other soft material like chamois soaked with normal-hexane.