

2SA1531, 2SA1531A

Silicon PNP epitaxial planar type

For low-frequency and low-noise amplification

Complementary to 2SC3929 and 2SC3929A

■ Features

- Low noise voltage NV
- High forward current transfer ratio h_{FE}
- S-Mini type package, allowing downsizing of the equipment and automatic insertion through the tape packing and the magazine packing

■ Absolute Maximum Ratings $T_a = 25^\circ\text{C}$

Parameter	Symbol	Rating	Unit
Collector-base voltage (Emitter open)	V_{CBO}	-35	V
	2SA1531A	-55	
Collector-emitter voltage (Base open)	V_{CEO}	-35	V
	2SA1531A	-55	
Emitter-base voltage (Collector open)	V_{EBO}	-5	V
Collector current	I_C	-50	mA
Peak collector current	I_{CP}	-100	mA
Collector power dissipation	P_C	150	mW
Junction temperature	T_j	150	$^\circ\text{C}$
Storage temperature	T_{stg}	-55 to +150	$^\circ\text{C}$

■ Electrical Characteristics $T_a = 25^\circ\text{C} \pm 3^\circ\text{C}$

Parameter	Symbol	Conditions	Min	Typ	Max	Unit
Collector-base voltage (Emitter open)	V_{CBO}	$I_C = -10 \mu\text{A}, I_E = 0$	-35			V
	2SA1531A		-55			
Collector-emitter voltage (Base open)	V_{CEO}	$I_C = -2 \text{mA}, I_B = 0$	-35			V
	2SA1531A		-55			
Emitter-base voltage (Collector open)	V_{EBO}	$I_E = -10 \mu\text{A}, I_C = 0$	-5			V
Base-emitter voltage	V_{BE}	$V_{CE} = -1 \text{V}, I_C = -100 \text{mA}$		-0.7	-1.0	V
Collector-base cutoff current (Emitter open)	I_{CBO}	$V_{CB} = -10 \text{V}, I_E = 0$			-0.1	μA
Collector-emitter cutoff current (Base open)	I_{CEO}	$V_{CE} = -10 \text{V}, I_B = 0$			-1	μA
Forward current transfer ratio *	h_{FE}	$V_{CE} = -5 \text{V}, I_C = -2 \text{mA}$	180		700	—
Collector-emitter saturation voltage	$V_{CE(sat)}$	$I_C = -100 \text{mA}, I_B = -10 \text{mA}$			-0.6	V
Transition frequency	f_T	$V_{CB} = -5 \text{V}, I_E = 2 \text{mA}, f = 200 \text{MHz}$		150		MHz
Noise voltage	NV	$V_{CE} = -10 \text{V}, I_C = -1 \text{mA}, G_V = 80 \text{dB}$ $R_g = 100 \text{k}\Omega, \text{Function} = \text{FLAT}$			150	mV

Note) 1. Measuring methods are based on JAPANESE INDUSTRIAL STANDARD JIS C 7030 measuring methods for transistors.

2. *: Rank classification

Rank	R	S	T
h_{FE}	180 to 360	260 to 520	360 to 700

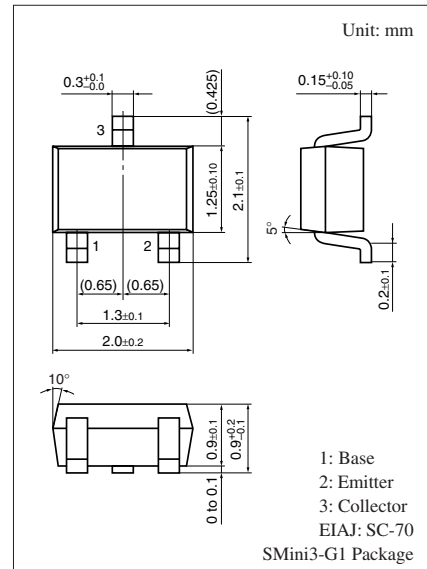

Marking Symbol:

- 2SA1531: F
- 2SA1531A: H

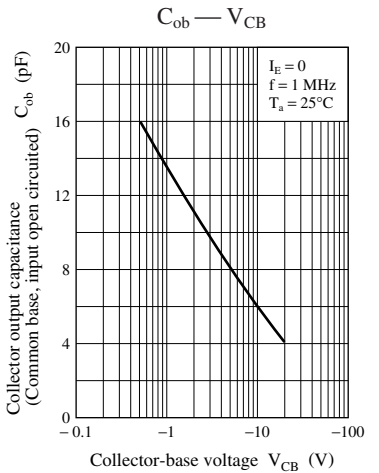
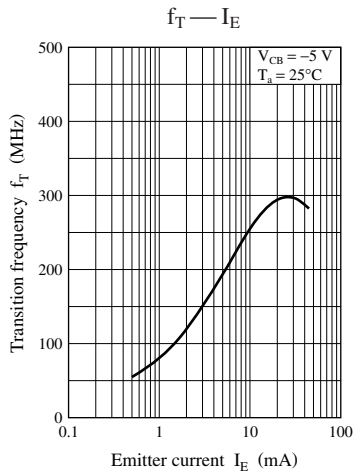
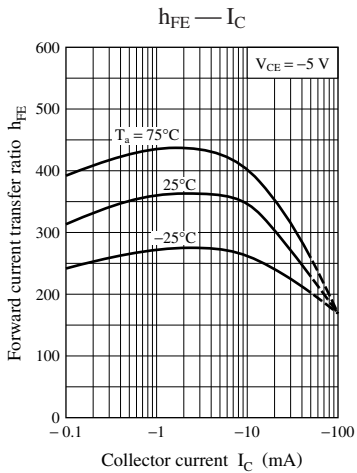
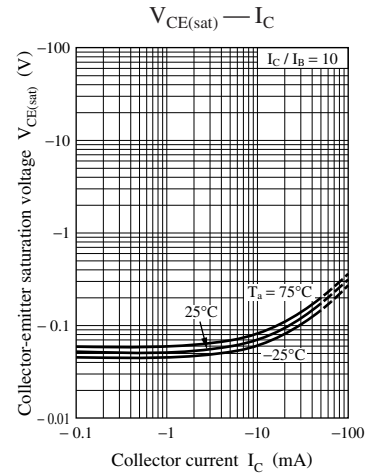
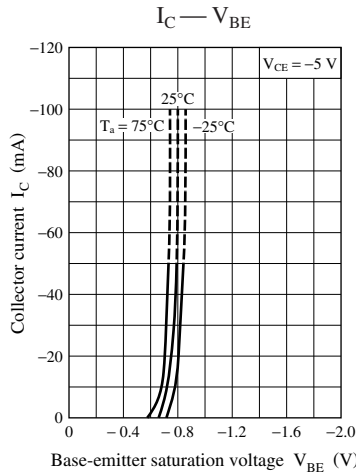
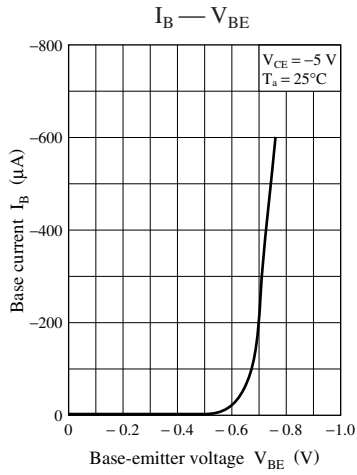
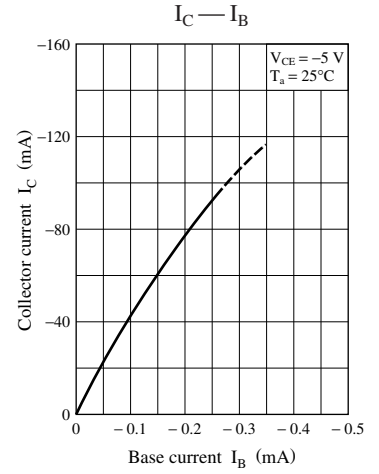
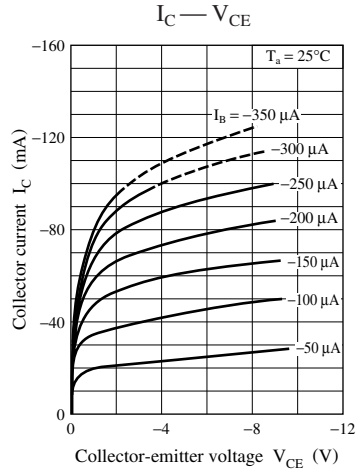
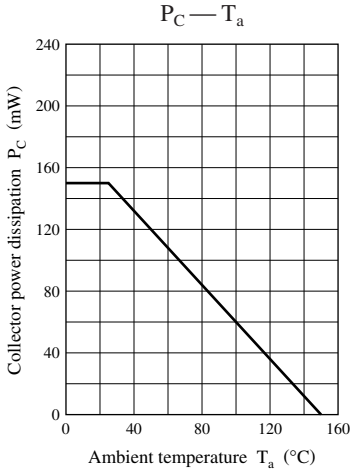

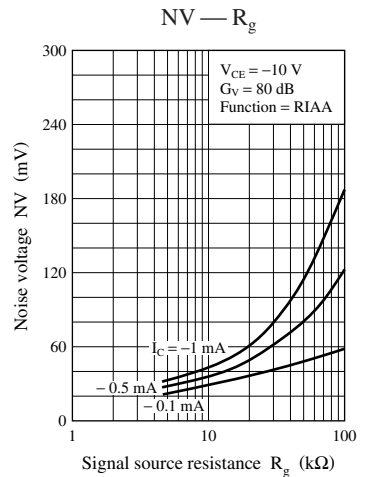
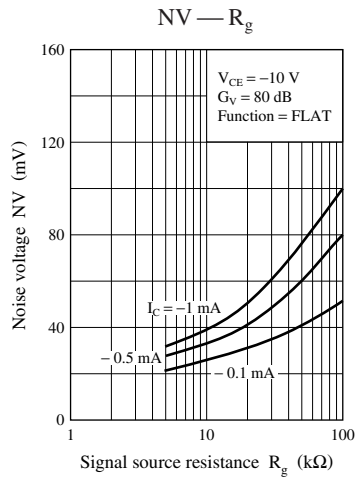
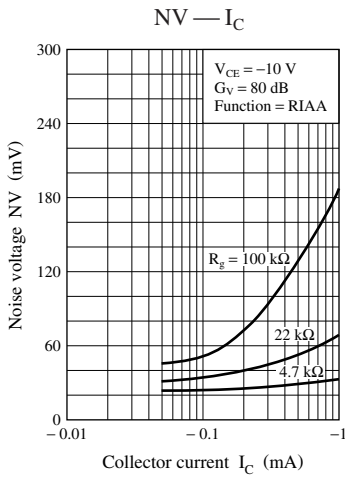
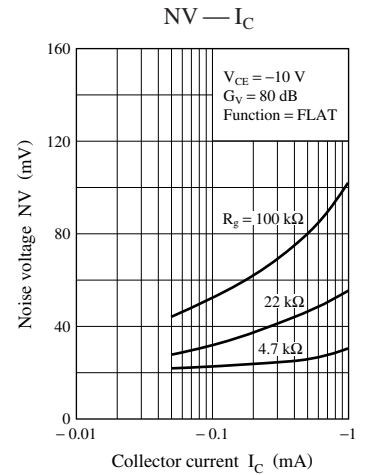
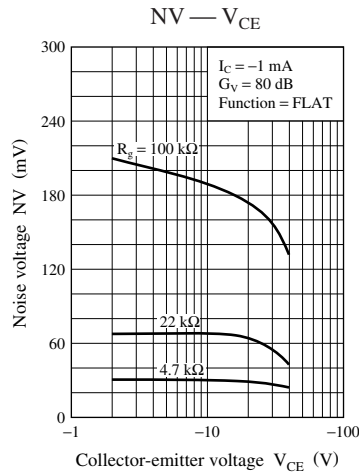
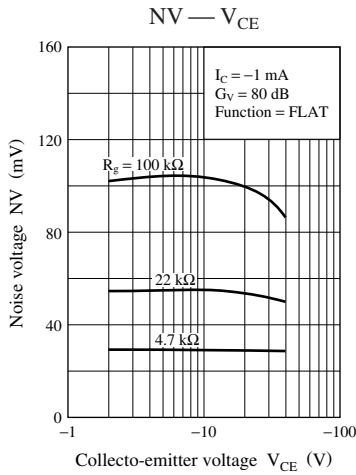

Request for your special attention and precautions in using the technical information and semiconductors described in this material

- (1) An export permit needs to be obtained from the competent authorities of the Japanese Government if any of the products or technologies described in this material and controlled under the "Foreign Exchange and Foreign Trade Law" is to be exported or taken out of Japan.
- (2) The technical information described in this material is limited to showing representative characteristics and applied circuits examples of the products. It neither warrants non-infringement of intellectual property right or any other rights owned by our company or a third party, nor grants any license.
- (3) We are not liable for the infringement of rights owned by a third party arising out of the use of the product or technologies as described in this material.
- (4) The products described in this material are intended to be used for standard applications or general electronic equipment (such as office equipment, communications equipment, measuring instruments and household appliances).
Consult our sales staff in advance for information on the following applications:
 - Special applications (such as for airplanes, aerospace, automobiles, traffic control equipment, combustion equipment, life support systems and safety devices) in which exceptional quality and reliability are required, or if the failure or malfunction of the products may directly jeopardize life or harm the human body.
 - Any applications other than the standard applications intended.
- (5) The products and product specifications described in this material are subject to change without notice for modification and/or improvement. At the final stage of your design, purchasing, or use of the products, therefore, ask for the most up-to-date Product Standards in advance to make sure that the latest specifications satisfy your requirements.
- (6) When designing your equipment, comply with the guaranteed values, in particular those of maximum rating, the range of operating power supply voltage, and heat radiation characteristics. Otherwise, we will not be liable for any defect which may arise later in your equipment.
Even when the products are used within the guaranteed values, take into the consideration of incidence of break down and failure mode, possible to occur to semiconductor products. Measures on the systems such as redundant design, arresting the spread of fire or preventing glitch are recommended in order to prevent physical injury, fire, social damages, for example, by using the products.
- (7) When using products for which damp-proof packing is required, observe the conditions (including shelf life and amount of time let standing of unsealed items) agreed upon when specification sheets are individually exchanged.
- (8) This material may be not reprinted or reproduced whether wholly or partially, without the prior written permission of Matsushita Electric Industrial Co., Ltd.