



ACS108-5Sx

ASD™ AC Switch Family

AC LINE SWITCH

MAIN APPLICATIONS

- AC on-off static switching in appliance & industrial control systems
- Drive of low power high inductive or resistive loads like:
 - relay, valve, solenoid, dispenser
 - pump, fan, micro-motor
 - low power lamp bulb, door lock

FEATURES

- Blocking voltage: $V_{DRM} / V_{RRM} = 500V$
- Clamping voltage: $V_{CL} = 600V$
- Nominal current: $I_{T(RMS)} = 0.8 A$
- Gate triggering current : $I_{GT} < 10 mA$
- Triggering current is sourced by the gate
- Switch integrated driver
- Drive reference COM connected to the SOT-223 tab

BENEFITS

- Needs no external overvoltage protection.
- Enables the equipment to meet IEC61000-4-5 standard.
- Allows straightforward connection of several SOT-223 devices on the same cooling pad.
- Reduces the switch component count by up to 80%.
- Interfaces directly with the microcontroller.
- Eliminates any stressing gate kick back on the microcontroller.

DESCRIPTION

The ACS108 belongs to the AC line switches built around the ASD™ concept. This high performance device is able to control an 0.8 A load device.

The ACS™ switch embeds a high voltage clamping structure to absorb the inductive turn-off energy and a gate level shifter driver to separate the digital controller from the main switch. It is triggered with a negative gate current flowing out of the gate pin.

For further technical information, please refer to AN1172 the Application note.

ASD and ACS are a trademarks of STMicroelectronics.

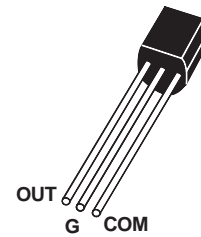

TO-92
ACS108-5SA

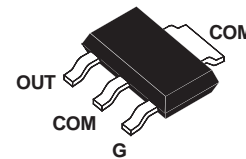

SOT-223
ACS108-5SN

FUNCTIONAL DIAGRAM

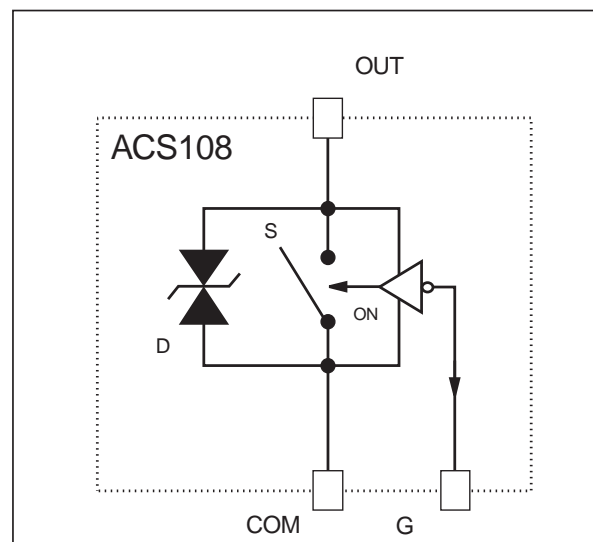

ACS108-5Sx

ABSOLUTE RATINGS (limiting values)

Symbol	Parameter		Value	Unit	
V_{DRM}/V_{RRM}	Repetitive peak off-state voltage		$T_j = 125\text{ °C}$	500	V
$I_{T(RMS)}$	RMS on-state current full cycle sine wave 50 to 60 Hz	TO-92	$T_{lead} = 75\text{ °C}$	0.8	A
		TO-92	$T_{amb} = 60\text{ °C}$	0.3	A
		SOT-223	$T_{amb} = 75\text{ °C}$	0.8	A
I_{TSM}	Non repetitive surge peak on-state current T_j initial = 25 °C , full cycle sine wave	$F = 50\text{ Hz}$		7.3	A
		$F = 60\text{ Hz}$		8	A
di/dt	Critical rate of repetitive rise of on-state current $I_G = 20\text{ mA}$ with $t_r = 100\text{ ns}$		$F = 120\text{ Hz}$	100	A/ μs
V_{PP}	Non repetitive line peak pulse voltage		note 1	2	kV
T_{stg}	Storage temperature range			- 40 to + 150	$^{\circ}\text{C}$
T_j	Operating junction temperature range			- 30 to + 125	$^{\circ}\text{C}$
T_l	Maximum lead temperature for soldering during 10s			260	$^{\circ}\text{C}$

Note 1: according to test described by IEC61000-4-5 standard & Figure 3.

SWITCH GATE CHARACTERISTICS (maximum values)

Symbol	Parameter	Value	Unit
$P_{G(AV)}$	Average gate power dissipation	0.1	W
I_{GM}	Peak gate current ($t_p = 20\mu\text{s}$)	1	A
V_{GM}	Peak positive gate voltage (respect to the pin COM)	5	V

THERMAL RESISTANCES

Symbol	Parameter	Value	Unit	
$R_{th(j-a)}$	Junction to ambient	TO-92	150	$^{\circ}\text{C/W}$
		SOT-223 (*)	60	$^{\circ}\text{C/W}$
$R_{th(j-l)}$	Junction to lead for full AC line cycle conduction	TO-92	60	$^{\circ}\text{C/W}$
$R_{th(j-t)}$	Junction to tab for full AC line cycle conduction	SOT-223	25	$^{\circ}\text{C/W}$

(*) : with 5 cm^2 copper ($e=35\mu\text{m}$) surface under tab

ELECTRICAL CHARACTERISTICS

For either positive or negative polarity of pin OUT voltage respect to pin COM voltage excepted note 3

Symbol	Test Conditions	Values	Unit
I_{GT}	$V_{OUT}=12\text{V}$ $R_L=140\Omega$ $T_j=25\text{ °C}$	MAX. 10	mA
V_{GT}	$V_{OUT}=12\text{V}$ $R_L=140\Omega$ $T_j=25\text{ °C}$	MAX. 1	V
V_{GD}	$V_{OUT}=V_{DRM}$ $R_L=3.3\text{k}\Omega$ $T_j=125\text{ °C}$	MIN. 0.15	V
I_H	$I_{OUT}= 100\text{ mA}$ gate open $T_j=25\text{ °C}$	TYP. 25	mA
		MAX. 60	mA
I_L	$I_G= 20\text{ mA}$ $T_j=25\text{ °C}$	TYP. 30	mA
		MAX. 65	mA
V_{TM}	$I_{OUT} = 1.1\text{ A}$ $t_p=500\mu\text{s}$ $T_j=25\text{ °C}$	MAX. 1.3	V
I_{DRM} I_{RRM}	$V_{OUT} = V_{DRM}$ $V_{OUT} = V_{RRM}$ $T_j=25\text{ °C}$	MAX. 2	μA
		$T_j=125\text{ °C}$ MAX. 200	μA
dV/dt	$V_{OUT}=400\text{V}$ gate open $T_j=110\text{ °C}$	MIN. 500	V/ μs
$(di/dt)_c$	$(dV/dt)_c=10\text{V}/\mu\text{s}$ $T_j=110\text{ °C}$	MIN. 0.1	A/ms
$(di/dt)_c^*$	$(dV/dt)_c = 15\text{V}/\mu\text{s}$ $I_{out} < 0$ (note 3) $T_j=110\text{ °C}$	MIN. 0.3	A/ms
V_{CL}	$I_{CL} = 1\text{ mA}$ $t_p=1\text{ ms}$ $T_j=25\text{ °C}$	TYP. 600	V

AC LINE SWITCH BASIC APPLICATION

The ACS108 device is well adapted to washing machines, dishwashers, tumble driers, refrigerators, water heaters and cookware. It has been especially designed to switch ON and OFF low power loads such as solenoids, valves, relays, dispensers, micro-motors, fans, pumps, door locks and low power lamp bulbs.

Pin COM: Common drive reference to connect to the power line neutral

Pin G: Switch Gate input to connect to the digital controller through the resistor

Pin OUT: Switch Output to connect to the Load

The ACS™ switch is triggered with a negative gate current flowing out of the gate pin G. It can be driven directly by the digital controller through a resistor as shown on the typical application diagram. No protection devices are required between the gates and common terminals.

The SOT-223 version allows several ACS108 devices to be connected on the same cooling PCB pad which is the COM pin : this cooling pad can be then reduced, and the printed circuit layout is simplified.

In appliance systems, the ACS108 switch intends to drive low power load in full cycle ON / OFF mode. The turn off commutation characteristics of these loads can be classified in 3 groups as shown in Table 1.

Thanks to its thermal and turn-off commutation characteristics, the ACS108 switch drives a load, such as door lock, lamp, relay, valve and micro motor, up to 0.2 A without any turn-off aid circuit. Switching off the ACS within one full AC line cycle will extend its current up to 0.8 A on resistive load.

Table 1: Load grouping versus their turn off commutation requirement (230V AC applications).

LOAD	Load IRMS Current (A)	POWER FACTOR	(di/dt)c (A/ms)	(dV/dt)c (V/μs)	TURN-OFF DELAY (ms)
Door Lock Lamp	< 0.3	1	0.15	0.15	<10
	< 0.8	1	0.4	0.15	< 20
Relay Valve Dispenser Micro-motor	< 0.1	> 0.7	< 0.05	< 5	< 10
Pump Fan	< 0.2	> 0.2	< 0.1	< 10	< 10
	< 0.6	> 0.2	< 0.3	< 10	< 20

TYPICAL APPLICATION DIAGRAM

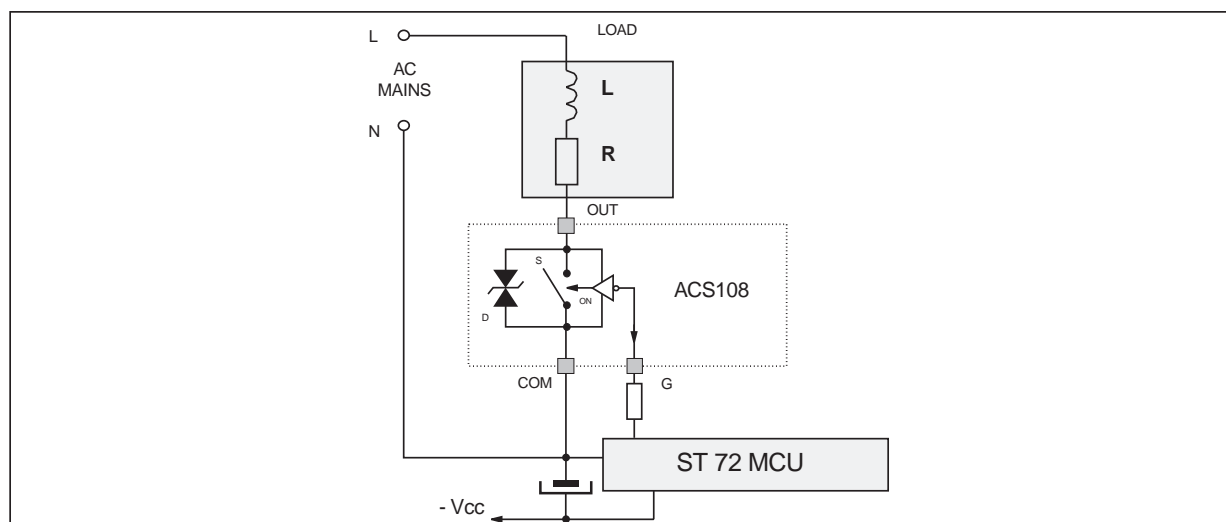

ACS108-5Sx

HIGH INDUCTIVE SWITCH-OFF OPERATION

At the end of the last conduction half-cycle, the load current reaches the holding current level I_H , and the ACS™ switch turns off. Because of the inductance L of the load, the current flows through the avalanche diode D and decreases linearly to zero. During this time, the voltage across the switch is limited to the clamping voltage V_{CL} .

The energy stored in the inductance of the load depends on the holding current I_H and the inductance (up to 10 H); it can reach about 20 mJ and is dissipated in the clamping section that is especially designed for that purpose.

Fig. 1: Turn-off operation of the ACS108 switch with an electro valve: waveform of the gate current I_G , pin OUT current I_{OUT} & voltage V_{OUT} .

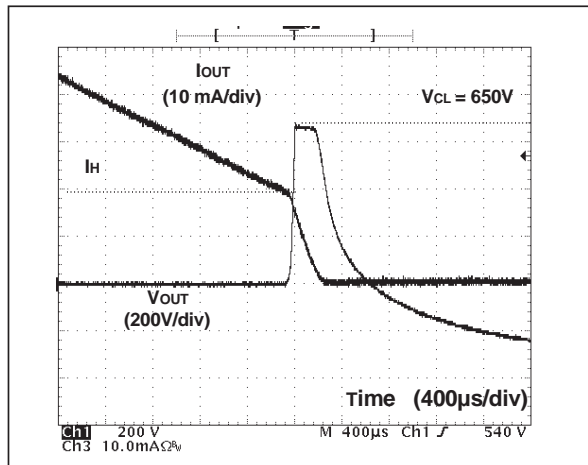
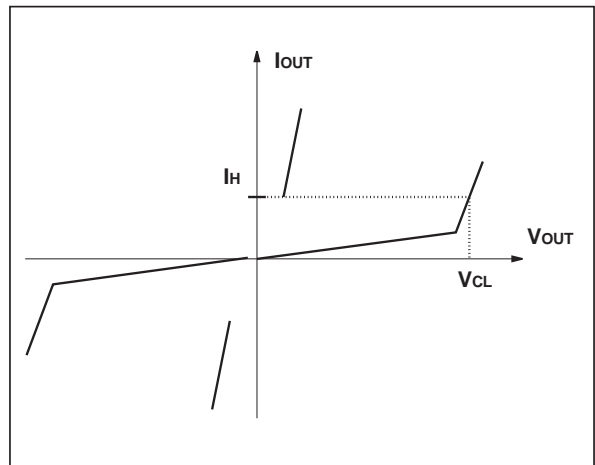

Fig. 2: ACS108 switch static characteristic.



AC LINE TRANSIENT VOLTAGE RUGGEDNESS

The ACS108 switch is able to safely withstand the AC line transient voltages either by clamping the low energy spikes or by breaking over under high energy shocks.

The test circuit in Figure 4 is representative of the final ACS™ application and is also used to stress the ACS™ switch according to the IEC61000-4-5 standard conditions. Thanks to the load, the ACS™ switch withstands the voltage spikes up to 2 kV above the peak line voltage. It will break over safely even on resistive load where the turn-on current rise is high as shown in Figure 4. Such non-repetitive testing can be done 10 times on each AC line voltage polarity.

Fig. 3: Overvoltage ruggedness test circuit for resistive and inductive loads according to IEC61000-4-5 standard.

$R = 150\Omega$, $L = 5\mu\text{H}$, $V_{PP} = 2\text{kV}$.

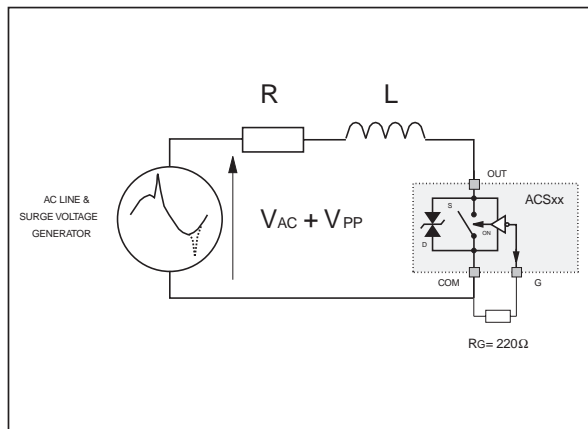

Fig. 4: Current and voltage of the ACS™ during IEC61000-4-5 standard test with a $150\Omega - 10\mu\text{H}$ load & $V_{PP} = 2\text{kV}$.

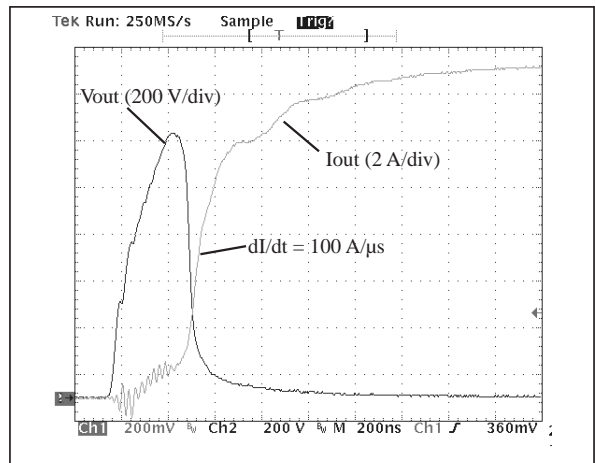

Fig. 5: Maximum power dissipation versus RMS on-state current.

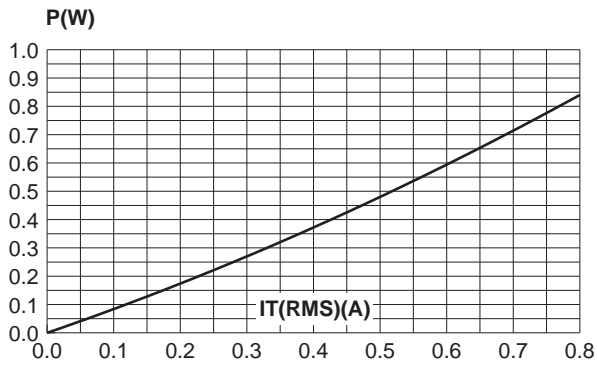

Fig. 6: RMS on-state current versus ambient temperature.

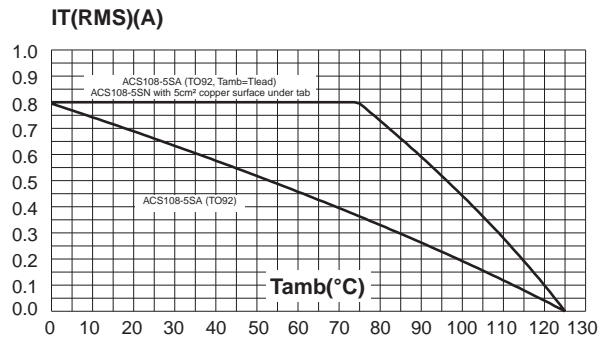

Fig. 7-1: Relative variation of thermal impedance junction to ambient versus pulse duration (ACS108-5SA) (TO-92).

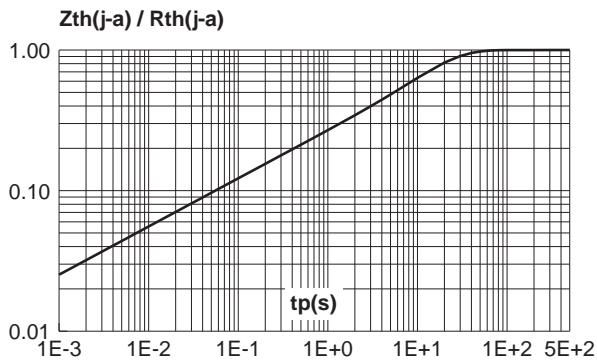

Fig. 7-2: Relative variation of thermal impedance junction to ambient versus pulse duration (ACS108-5SN) (SOT-223).

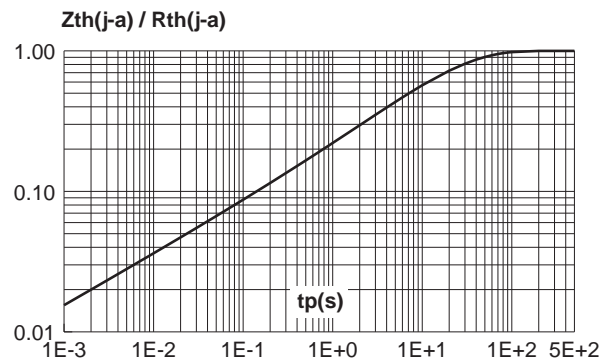

Fig. 8: Relative variation of gate trigger current versus junction temperature.

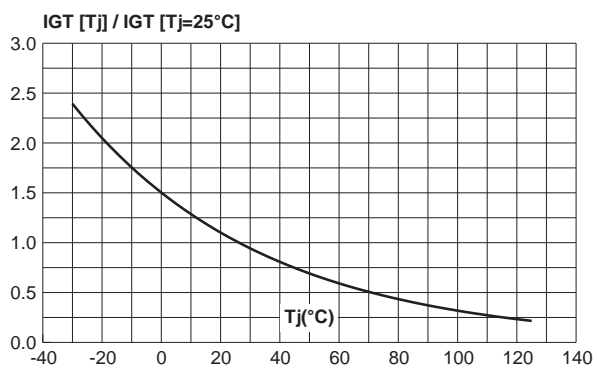

Fig. 9: Relative variation of holding and latching current versus junction temperature.

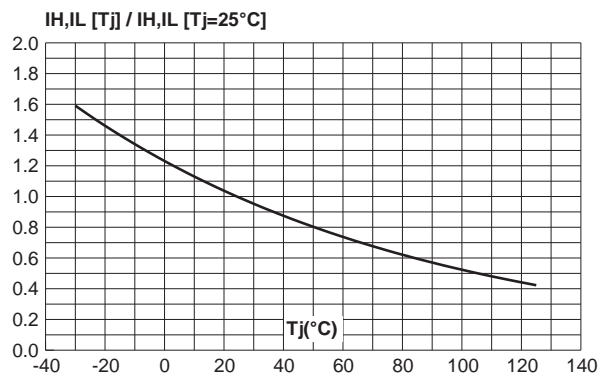

Fig. 10: Non repetitive surge peak on-state current versus number of cycles.

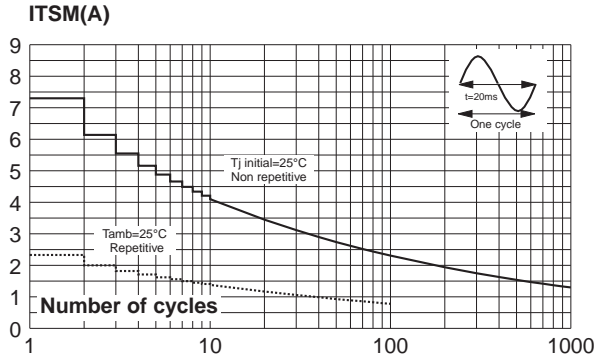

Fig. 12: On-state characteristics (maximum values).

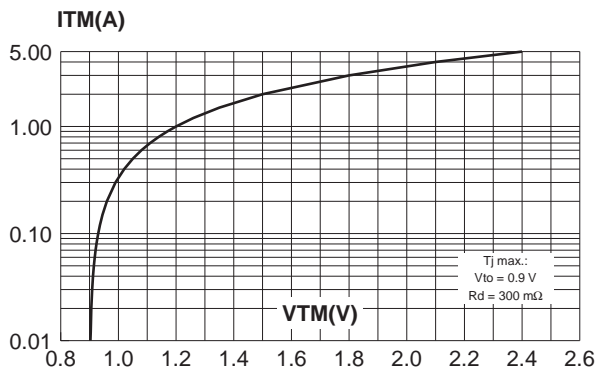

Fig. 14: Relative variation of critical $(di/dt)_c$ versus junction temperature.

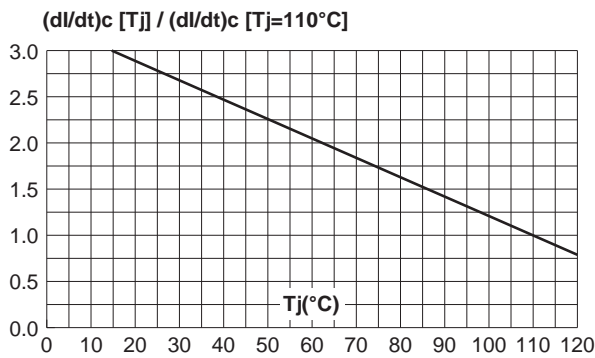

Fig. 11: Non-repetitive surge peak on-state current for a sinusoidal pulse, with width $t_p < 10ms$, and corresponding value of I^2t .

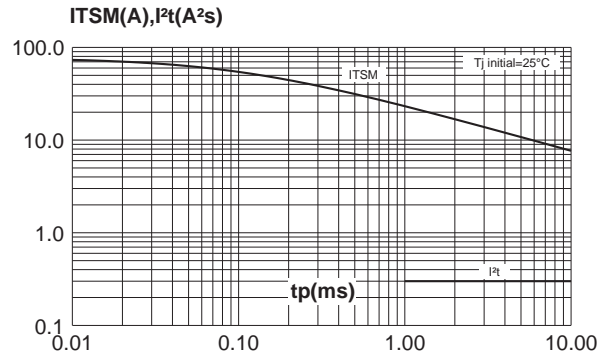
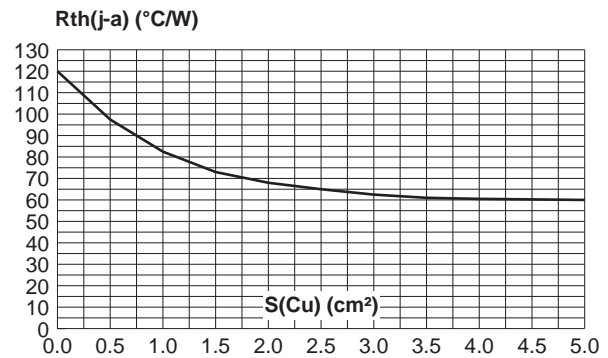
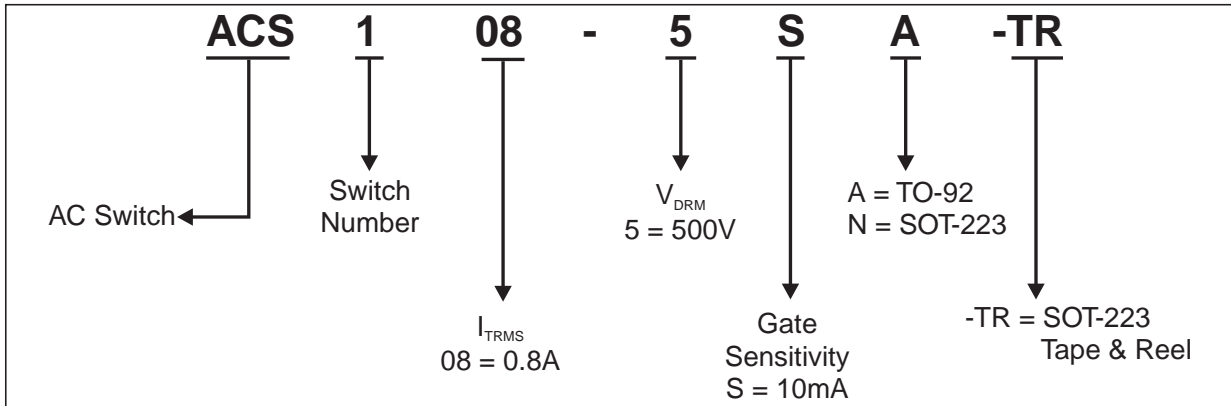

Fig. 13: Thermal resistance junction to ambient versus copper surface under tab (Epoxy printed circuit board FR4, copper thickness: 35 μ m).



ORDERING INFORMATION



PACKAGE MECHANICAL DATA
SOT-223

REF.	DIMENSIONS					
	Millimeters			Inches		
	Min.	Typ.	Max.	Min.	Typ.	Max.
A			1.80			0.071
A1	0.02		0.10	0.001		0.004
B	0.60	0.70	0.85	0.024	0.027	0.033
B1	2.90	3.00	3.15	0.114	0.118	0.124
c	0.24	0.26	0.35	0.009	0.010	0.014
D	6.30	6.50	6.70	0.248	0.256	0.264
e		2.3			0.090	
e1		4.6			0.181	
E	3.30	3.50	3.70	0.130	0.138	0.146
H	6.70	7.00	7.30	0.264	0.276	0.287
V	10° max					

PIN	DESCRIPTION
1	GATE BASE
2	DRAIN COLLECTOR
3	SOURCE EMITTER
4	DRAIN COLLECTOR

PACKAGE MECHANICAL DATA
SOT-223

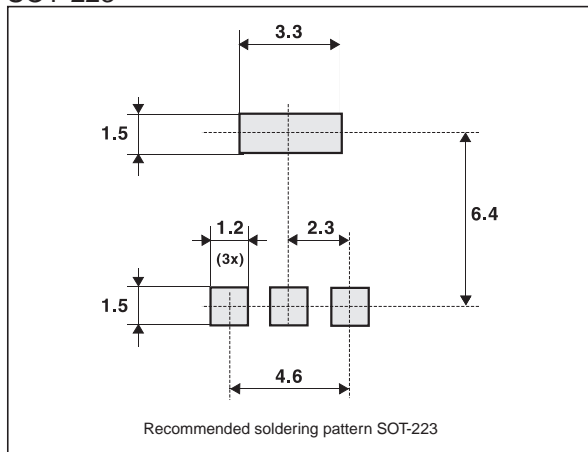

ACS108-5Sx

PACKAGE MECHANICAL DATA

TO-92 (Plastic)

REF.	DIMENSIONS					
	Millimeters			Inches		
	Min.	Typ.	Max.	Min.	Typ.	Max.
A		1.35			0.053	
B			4.70			0.185
C		2.54			0.100	
D	4.40			0.173		
E	12.70			0.500		
F			3.70			0.146
a			0.45			0.017

OTHER INFORMATION

Ordering type	Marking	Package	Weight	Base qty	Delivery mode
ACS108-5SA	ACS08/5S	TO-92	0.2 g	2500	Bulk
ACS108-5SA-TR	ACS08/5S	TO-92	0.2 g	2000	Tape & reel
ACS108-5SN	ACS/085S	SOT-223	0.12 g	1000	Tape & reel

Information furnished is believed to be accurate and reliable. However, STMicroelectronics assumes no responsibility for the consequences of use of such information nor for any infringement of patents or other rights of third parties which may result from its use. No license is granted by implication or otherwise under any patent or patent rights of STMicroelectronics. Specifications mentioned in this publication are subject to change without notice. This publication supersedes and replaces all information previously supplied. STMicroelectronics products are not authorized for use as critical components in life support devices or systems without express written approval of STMicroelectronics.

The ST logo is a registered trademark of STMicroelectronics

© 2001 STMicroelectronics - Printed in Italy - All rights reserved.

STMicroelectronics GROUP OF COMPANIES

Australia - Brazil - China - Finland - France - Germany - Hong Kong - India - Italy - Japan - Malaysia
Malta - Morocco - Singapore - Spain - Sweden - Switzerland - United Kingdom - U.S.A.

<http://www.st.com>