

\*RoHS COMPLIANT

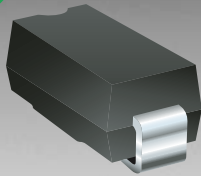

**BOURNS®**

## Features

- Lead free device (RoHS compliant\*)
- Glass passivated chip
- Low reverse leakage current
- Low forward voltage drop
- High current capability

## CD214C-R350~R31000 Glass Passivated Rectifiers

### General Information

The markets of portable communications, computing and video equipment are challenging the semiconductor industry to develop increasingly smaller electronic components. Bourns offers Glass Passivated Rectifiers for rectification applications, in compact chip DO-214AB (SMC) size format, which offer PCB real estate savings and are considerably smaller than competitive parts. The Glass Passivated Rectifier Diodes offer a forward current of 3.0 A with a choice of repetitive peak reverse voltage of 50 V up to 1000 V.

Bourns Chip Diodes conform to JEDEC standards, are easy to handle on standard pick and place equipment and their flat configuration minimizes roll away.

### Electrical Characteristics (@ $T_A = 25\text{ }^\circ\text{C}$ Unless Otherwise Noted)

Parameter	Symbol	CD214C-							Unit
		R350	R3100	R3200	R3400	R3600	R3800	R31000	
Maximum Repetitive Peak Reverse Voltage	$V_{RRM}$	50	100	200	400	600	800	1000	V
Maximum RMS Voltage	$V_{RMS}$	35	70	140	280	420	560	700	V
Maximum DC Blocking Voltage	$V_{DC}$	50	100	200	400	600	800	1000	V
Maximum Average Forward Rectified Current (@ $T_L = 100\text{ }^\circ\text{C}$ ) <sup>1</sup>	$I_{(AV)}$	3.0							A
DC Reverse Current @ Rated DC Blocking Voltage (@ $T_J = 25\text{ }^\circ\text{C}$ )	$I_R$	10.0							$\mu\text{A}$
DC Reverse Current @ Rated DC Blocking Voltage (@ $T_J = 125\text{ }^\circ\text{C}$ )	$I_R$	250.0							$\mu\text{A}$
Typical Junction Capacitance <sup>2</sup>	$C_J$	40							pF
Maximum Instantaneous Forward Voltage @ 3 A	$V_F$	1.15							V
Typical Thermal Resistance <sup>3</sup>	$R_{\theta JA}$	10							$^\circ\text{C/W}$
Peak forward surge current 8.3 ms single half sine-wave superimposed on rated load (JEDEC Method)	$I_{FSM}$	100							A

Notes:

- 1 See Forward Derating Curve.
- 2 Measured at 1 MHz and an applied reverse voltage of 4.0 V.
- 3 Thermal resistance from junction to lead.

### Thermal Characteristics (@ $T_A = 25\text{ }^\circ\text{C}$ Unless Otherwise Noted)

Parameter	Symbol	CD214C-R350-R31000	Unit
Operating Temperature Range	$T_J$	-65 to +175	$^\circ\text{C}$
Storage Temperature Range	$T_{STG}$	-65 to +175	$^\circ\text{C}$

# CD214C-R350~R31000 Glass Passivated Rectifiers



## Product Dimensions

This is a lead free product using 100 % Sn termination. It is a molded plastic package. A cathode band indicates the polarity. The package weighs approximately 0.21 g. The package and dimensions are shown below.

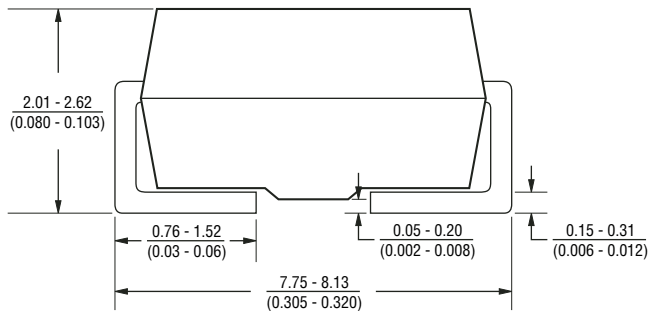
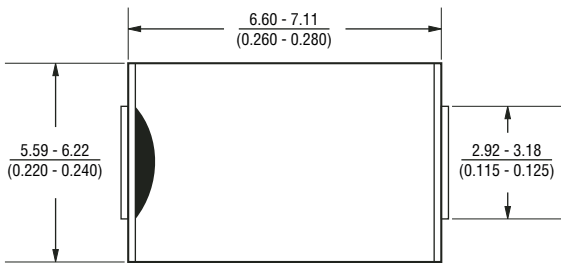

DIMENSIONS:  $\frac{\text{MM}}{\text{(INCHES)}}$

## Recommended Pad Layout

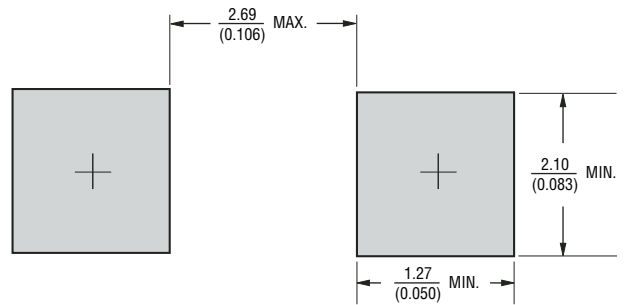

DIMENSIONS:  $\frac{\text{MM}}{\text{(INCHES)}}$

## How To Order

	<b>CD 214C - R 3 50</b>
Common Code	_____
CD = Chip Diode	_____
Package	_____
214C = SMC/DO-214AB	_____
Model Series	_____
R = Glass Passivated Rectifiers	_____
Forward Current $I_{AV}$	_____
3 = 3 A	_____
Reverse Voltage	_____
50 = 50 V	_____
100 = 100 V	_____
200 = 200 V	_____
400 = 400 V	_____
600 = 600 V	_____
800 = 800 V	_____
1000 = 1000 V	_____

## Typical Part Marking

CD214C-R350.....	<b>R3A</b>
CD214C-R3100.....	<b>R3B</b>
CD214C-R3200.....	<b>R3D</b>
CD214C-R3400.....	<b>R3G</b>
CD214C-R3600.....	<b>R3J</b>
CD214C-R3800.....	<b>R3K</b>
CD214C-R31000.....	<b>R3M</b>

# CD214C-R350~R31000 Glass Passivated Rectifiers

**BOURNS®**

## Packaging Information

The product will be dispensed in Tape and Reel format (see diagram below).

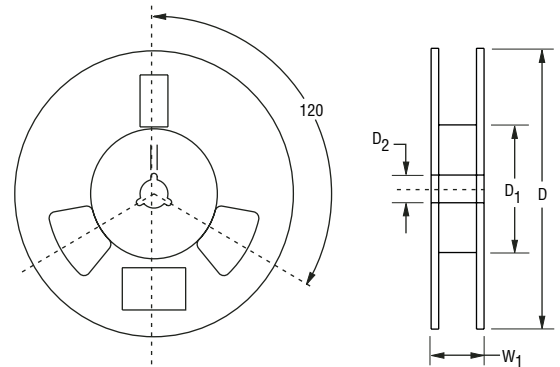
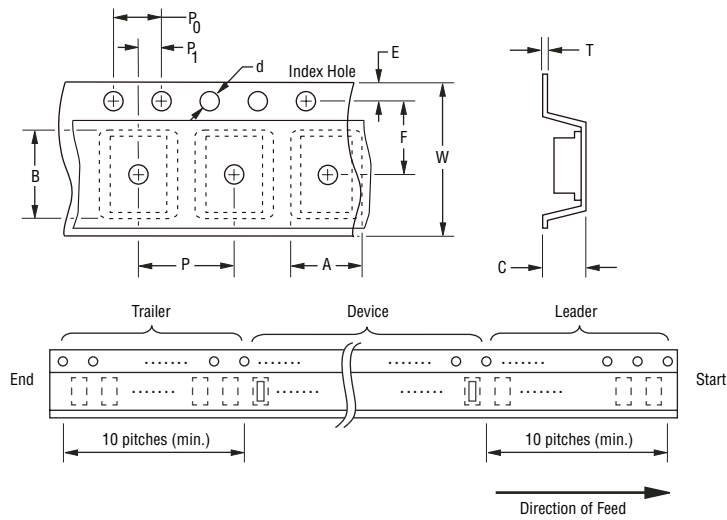

DIMENSIONS:  $\frac{\text{MM}}{\text{(INCHES)}}$

Devices are packed in accordance with EIA standard RS-481-A and specifications shown here.

Item	Symbol	SMC (DO-214AB)
Carrier Width	A	$\frac{7.22 \pm 0.10}{(0.284 \pm 0.004)}$
Carrier Length	B	$\frac{8.11 \pm 0.10}{(0.319 \pm 0.004)}$
Carrier Depth	C	$\frac{2.36 \pm 0.10}{(0.093 \pm 0.004)}$
Sprocket Hole	d	$\frac{1.55 \pm 0.05}{(0.061 \pm 0.002)}$
Reel Outside Diameter	D	$\frac{330}{(12.992)}$
Reel Inner Diameter	D <sub>1</sub>	$\frac{50.0}{(1.969)}$ Min.
Feed Hole Diameter	D <sub>2</sub>	$\frac{13.0 \pm 0.20}{(0.512 \pm 0.008)}$
Sprocket Hole Position	E	$\frac{1.75 \pm 0.10}{(0.069 \pm 0.004)}$
Punch Hole Position	F	$\frac{7.50 \pm 0.10}{(0.295 \pm 0.004)}$
Punch Hole Pitch	P	$\frac{4.00 \pm 0.10}{(0.157 \pm 0.004)}$
Sprocket Hole Pitch	P <sub>0</sub>	$\frac{4.00 \pm 0.10}{(0.157 \pm 0.004)}$
Embossment Center	P <sub>1</sub>	$\frac{2.00 \pm 0.10}{(0.079 \pm 0.004)}$
Overall Tape Thickness	T	$\frac{0.30 \pm 0.10}{(0.012 \pm 0.004)}$
Tape Width	W	$\frac{16.00 \pm 0.20}{(0.630 \pm 0.008)}$
Reel Width	W <sub>1</sub>	$\frac{22.4}{(0.882)}$ Max.
Quantity per Reel	—	3,000

Specifications are subject to change without notice. Customers should verify actual device performance in their specific applications.

Performance Graphs

Forward Current Derating Curve

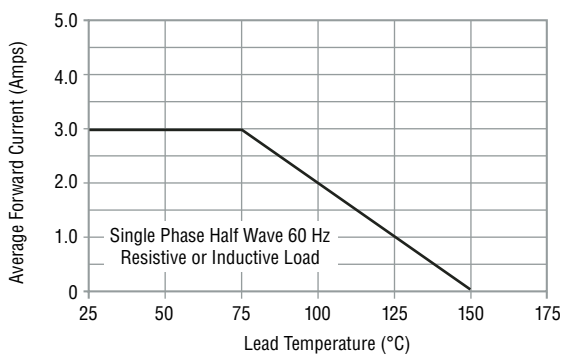

Maximum Non-Repetitive Surge Current

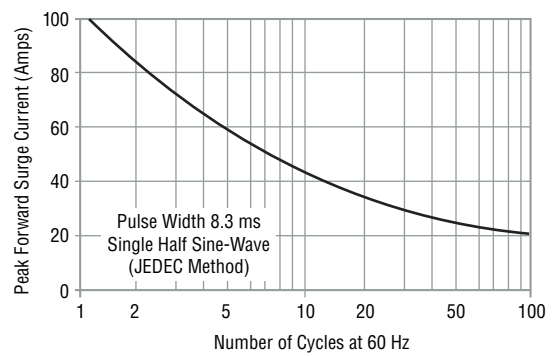

Typical Forward Characteristics

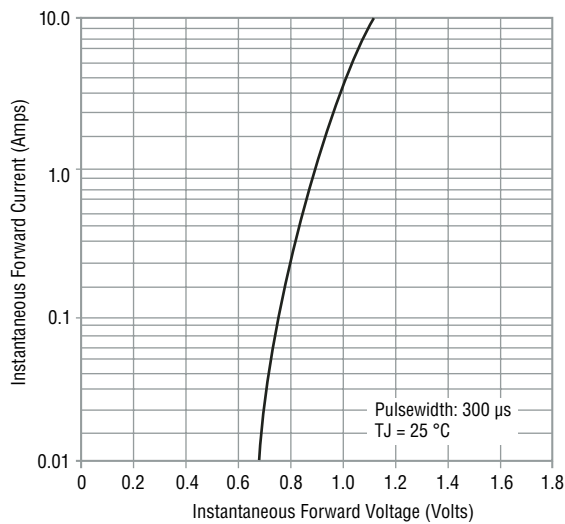

Typical Reverse Characteristics

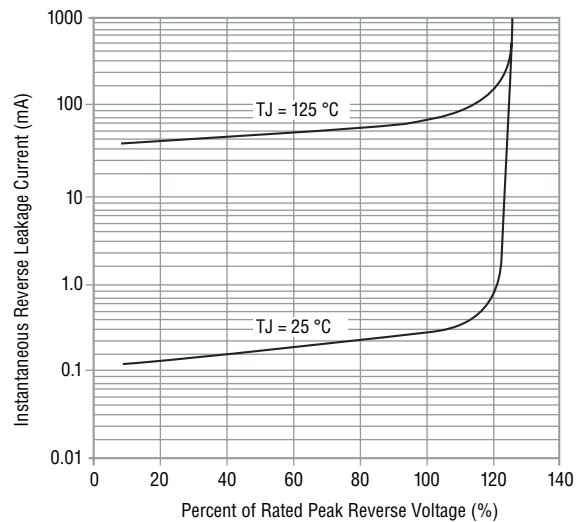

Reliable Electronic Solutions

Asia-Pacific:

Tel: +886-2 2562-4117 • Fax: +886-2 2562-4116

Europe:

Tel: +41-41 768 5555 • Fax: +41-41 768 5510

The Americas:

Tel: +1-951 781-5500 • Fax: +1-951 781-5700

[www.bourns.com](http://www.bourns.com)