

# RF Power Field Effect Transistors

## N-Channel Enhancement-Mode Lateral MOSFETs

Designed for N-CDMA, GSM and GSM EDGE base station applications with frequencies from 865 to 960 MHz. Suitable for multicarrier amplifier applications.

- Typical Single-Carrier N-CDMA. Performance @ 880 MHz:  $V_{DD} = 28$  Volts,  $I_{DQ} = 1200$  mA,  $P_{out} = 35$  Watts Avg., IS-95 CDMA (Pilot, Sync, Paging, Traffic Codes 8 Through 13) Channel Bandwidth = 1.2288 MHz. PAR = 9.8 dB @ 0.01% Probability on CCDF.  
 Power Gain — 21 dB  
 Drain Efficiency — 31%  
 ACPR @ 750 kHz Offset — -46.8 dBc in 30 kHz Bandwidth
- Capable of Handling 10:1 VSWR, @ 32 Vdc, 880 MHz, 3 dB Overdrive, Designed for Enhanced Ruggedness.

### Features

- Characterized with Series Equivalent Large-Signal Impedance Parameters
- Internally Matched for Ease of Use
- Qualified Up to a Maximum of 32  $V_{DD}$  Operation
- Integrated ESD Protection
- RoHS Compliant
- In Tape and Reel. R3 Suffix = 250 Units per 56 mm, 13 inch Reel.

**MRFE6S9160HR3**  
**MRFE6S9160HSR3**

**880 MHz, 35 W AVG., 28 V**  
**SINGLE N-CDMA**  
**LATERAL N-CHANNEL**  
**RF POWER MOSFETs**

**CASE 465-06, STYLE 1**  
**NI-780**  
**MRFE6S9160HR3**

**CASE 465A-06, STYLE 1**  
**NI-780S**  
**MRFE6S9160HSR3**

**Table 1. Maximum Ratings**

Rating	Symbol	Value	Unit
Drain-Source Voltage	$V_{DSS}$	-0.5, +66	Vdc
Gate-Source Voltage	$V_{GS}$	-0.5, +12	Vdc
Storage Temperature Range	$T_{stg}$	-65 to +150	°C
Case Operating Temperature	$T_C$	150	°C
Operating Junction Temperature (1,2)	$T_J$	225	°C

**Table 2. Thermal Characteristics**

Characteristic	Symbol	Value (2,3)	Unit
Thermal Resistance, Junction to Case Case Temperature 81°C, 160 W CW Case Temperature 73°C, 35 W CW	$R_{\theta JC}$	0.31 0.33	°C/W

1. Continuous use at maximum temperature will affect MTTF.
2. MTTF calculator available at <http://www.freescale.com/rtf>. Select Software & Tools/Development Tools/Calculators to access MTTF calculators by product.
3. Refer to AN1955, *Thermal Measurement Methodology of RF Power Amplifiers*. Go to <http://www.freescale.com/rtf>. Select Documentation/Application Notes - AN1955.

**Table 3. ESD Protection Characteristics**

Test Methodology	Class
Human Body Model (per JESD22-A114)	1A (Minimum)
Machine Model (per EIA/JESD22-A115)	A (Minimum)
Charge Device Model (per JESD22-C101)	IV (Minimum)

**Table 4. Electrical Characteristics** ( $T_C = 25^\circ\text{C}$  unless otherwise noted)

Characteristic	Symbol	Min	Typ	Max	Unit
<b>Off Characteristics</b>					
Zero Gate Voltage Drain Leakage Current ( $V_{DS} = 66\text{ Vdc}$ , $V_{GS} = 0\text{ Vdc}$ )	$I_{DSS}$	—	—	10	$\mu\text{Adc}$
Zero Gate Voltage Drain Leakage Current ( $V_{DS} = 28\text{ Vdc}$ , $V_{GS} = 0\text{ Vdc}$ )	$I_{DSS}$	—	—	1	$\mu\text{Adc}$
Gate-Source Leakage Current ( $V_{GS} = 5\text{ Vdc}$ , $V_{DS} = 0\text{ Vdc}$ )	$I_{GSS}$	—	—	10	$\mu\text{Adc}$

**On Characteristics**

Gate Threshold Voltage ( $V_{DS} = 10\text{ Vdc}$ , $I_D = 525\ \mu\text{Adc}$ )	$V_{GS(th)}$	1	2	3	Vdc
Gate Quiescent Voltage ( $V_{DS} = 28\text{ Vdc}$ , $I_D = 1200\text{ mAdc}$ )	$V_{GS(Q)}$	—	3	—	Vdc
Fixture Gate Quiescent Voltage <sup>(1)</sup> ( $V_{DD} = 28\text{ Vdc}$ , $I_D = 1200\text{ mAdc}$ , Measured in Functional Test)	$V_{GG(Q)}$	2.1	3.17	4.22	Vdc
Drain-Source On-Voltage ( $V_{GS} = 10\text{ Vdc}$ , $I_D = 3.6\text{ Adc}$ )	$V_{DS(on)}$	0.1	0.175	0.3	Vdc

**Dynamic Characteristics <sup>(2)</sup>**

Reverse Transfer Capacitance ( $V_{DS} = 28\text{ Vdc} \pm 30\text{ mV(rms)ac}$ @ 1 MHz, $V_{GS} = 0\text{ Vdc}$ )	$C_{rss}$	—	2.2	—	pF
Output Capacitance ( $V_{DS} = 28\text{ Vdc} \pm 30\text{ mV(rms)ac}$ @ 1 MHz, $V_{GS} = 0\text{ Vdc}$ )	$C_{oss}$	—	80.2	—	pF

**Functional Tests** (In Freescale Test Fixture, 50 ohm system)  $V_{DD} = 28\text{ Vdc}$ ,  $I_{DQ} = 1200\text{ mA}$ ,  $P_{out} = 35\text{ W Avg. N-CDMA}$ ,  $f = 880\text{ MHz}$ , Single-Carrier N-CDMA, 1.2288 MHz Channel Bandwidth Carrier. ACPR measured in 30 kHz Channel Bandwidth @  $\pm 750\text{ kHz}$  Offset. PAR = 9.8 dB @ 0.01% Probability on CCDF.

Power Gain	$G_{ps}$	20	21	23	dB
Drain Efficiency	$\eta_D$	29	31	—	%
Adjacent Channel Power Ratio	ACPR	—	-46.8	-45	dBc
Input Return Loss	IRL	—	-17	-9	dB

1.  $V_{GG} = 19/18 \times V_{GS(Q)}$ . Parameter measured on Freescale Test Fixture, due to resistive divider network on the board. Refer to Test Circuit schematic.

2. Part is internally matched on input.

(continued)

**Table 4. Electrical Characteristics** ( $T_C = 25^\circ\text{C}$  unless otherwise noted) (continued)

Characteristic	Symbol	Min	Typ	Max	Unit
<b>Typical Performances</b> (In Freescale Test Fixture, 50 ohm system) $V_{DD} = 28\text{ Vdc}$ , $I_{DQ} = 1200\text{ mA}$ , 865-900 MHz Bandwidth					
Video Bandwidth @ 160 W PEP $P_{out}$ where $IM3 = -30\text{ dBc}$ (Tone Spacing from 100 kHz to VBW) $\Delta IMD3 = IMD3 @ \text{VBW frequency} - IMD3 @ 100\text{ kHz} < 1\text{ dBc}$ (both sidebands)	VBW	—	10	—	MHz
Gain Flatness in 35 MHz Bandwidth @ $P_{out} = 35\text{ W Avg.}$	$G_F$	—	0.5	—	dB
Gain Variation over Temperature ( $-30^\circ\text{C}$ to $+85^\circ\text{C}$ )	$\Delta G$	—	0.016	—	dB/ $^\circ\text{C}$
Output Power Variation over Temperature ( $-30^\circ\text{C}$ to $+85^\circ\text{C}$ )	$\Delta P_{1dB}$	—	0.008	—	dBm/ $^\circ\text{C}$

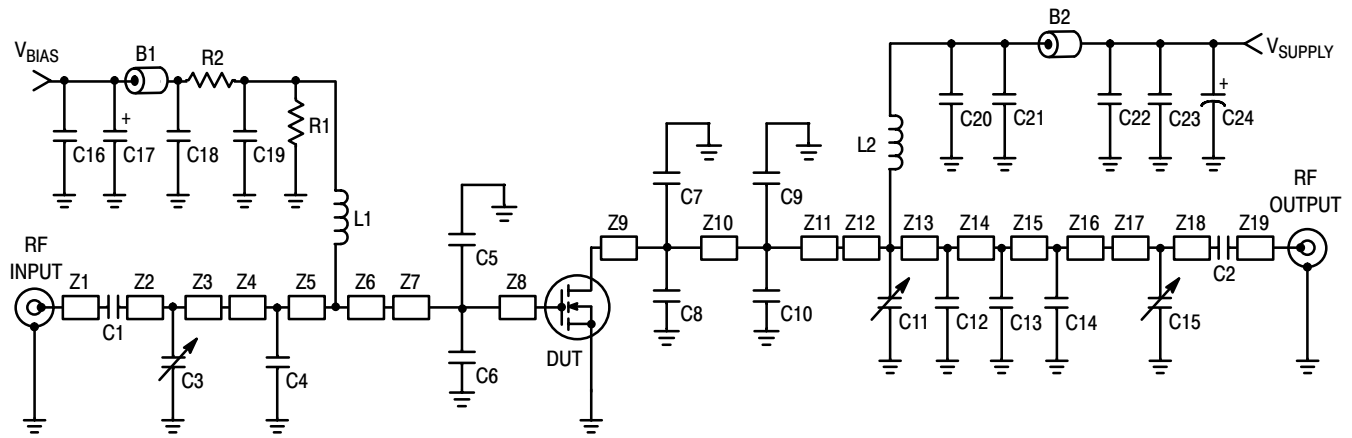

Z1	0.426" x 0.080" Microstrip	Z11	0.066" x 0.630" Microstrip
Z2	0.813" x 0.080" Microstrip	Z12	0.630" x 0.425" x 0.220" Taper
Z3	0.471" x 0.080" Microstrip	Z13	0.120" x 0.220" Microstrip
Z4	0.319" x 0.220" Microstrip	Z14	0.292" x 0.220" Microstrip
Z5	0.171" x 0.220" Microstrip	Z15	0.023" x 0.220" Microstrip
Z6	0.200" x 0.425" x 0.630" Taper	Z16	0.030" x 0.220" Microstrip
Z7	0.742" x 0.630" Microstrip	Z17	0.846" x 0.080" Microstrip
Z8	0.233" x 0.630" Microstrip	Z18	0.440" x 0.080" Microstrip
Z9	0.128" x 0.630" Microstrip	Z19	0.434" x 0.080" Microstrip
Z10	0.134" x 0.630" Microstrip	PCB	Arlon CuClad 250GX-0300-55-22, 0.030", $\epsilon_r = 2.55$

**Figure 1. MRFE6S9160HR3(SR3) Test Circuit Schematic**

**Table 5. MRFE6S9160HR3(SR3) Test Circuit Component Designations and Values**

Part	Description	Part Number	Manufacturer
B1, B2	Ferrite Beads, Small	2743019447	Fair Rite
C1, C2, C19	47 pF Chip Capacitors	ATC100B470JT500XT	ATC
C3, C11	0.8-8.0 pF Variable Capacitors, Gigatrim	27291SL	Johanson
C4	2.7 pF Chip Capacitor	ATC100B2R7JT500XT	ATC
C5, C6	15 pF Chip Capacitors	ATC100B150JT500XT	ATC
C7, C8	12 pF Chip Capacitors	ATC100B120JT500XT	ATC
C9, C10	4.3 pF Chip Capacitors	ATC100B4R3JT500XT	ATC
C12	8.2 pF Chip Capacitor	ATC100B8R2JT500XT	ATC
C13, C14	3.9 pF Chip Capacitors	ATC100B3R9JT500XT	ATC
C15	0.6-4.5 pF Variable Capacitor, Gigatrim	27271SL	Johanson
C16	22 pF Chip Capacitor	ATC100B220JT500XT	ATC
C17	1 $\mu$ F, 50 V Tantalum Capacitor	T491C105K0J0AT	Kemet
C18	20K pF Chip Capacitor	CDR35BP203AKYS	Kemet
C20	180 pF Chip Capacitor	ATC100B181JT500XT	ATC
C21, C22, C23	10 $\mu$ F, 50 V Chip Capacitors	GRM55DR61H106KA88B	Murata
C24	470 $\mu$ F, 63 V Electrolytic Capacitor	ESME630ELL471MK25S	United Chemi-Con
L1, L2	10 nH Inductors	0603HC	Coilcraft
R1	180 $\Omega$ , 1/4 W Chip Resistor	CRCW12061800FKEA	Vishay
R2	10 $\Omega$ , 1/4 W Chip Resistor	CRCW120610R0FKEA	Vishay

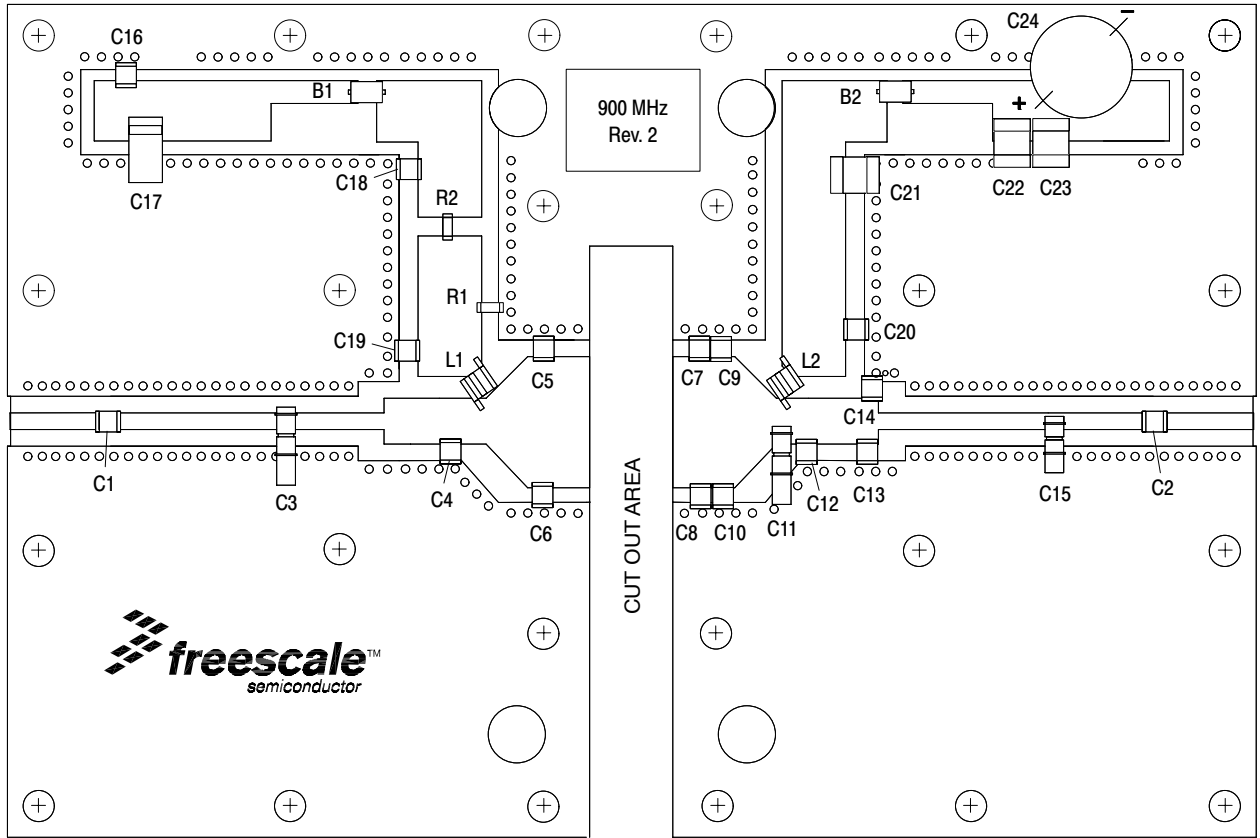

Figure 2. MRFE6S9160HR3(SR3) Test Circuit Component Layout

## TYPICAL CHARACTERISTICS

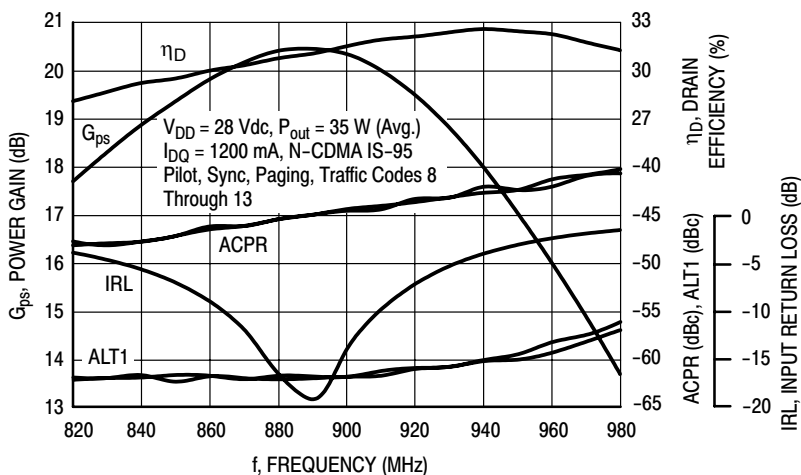

Figure 3. Single-Carrier N-CDMA Broadband Performance @  $P_{out} = 35$  Watts Avg.

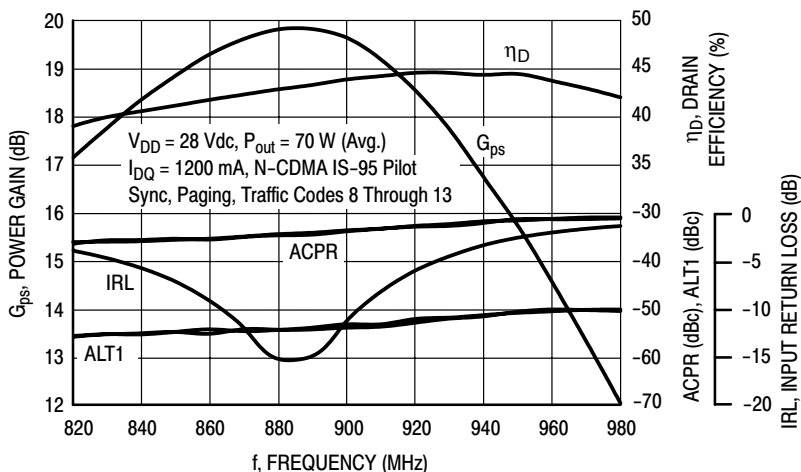

Figure 4. Single-Carrier N-CDMA Broadband Performance @  $P_{out} = 70$  Watts Avg.

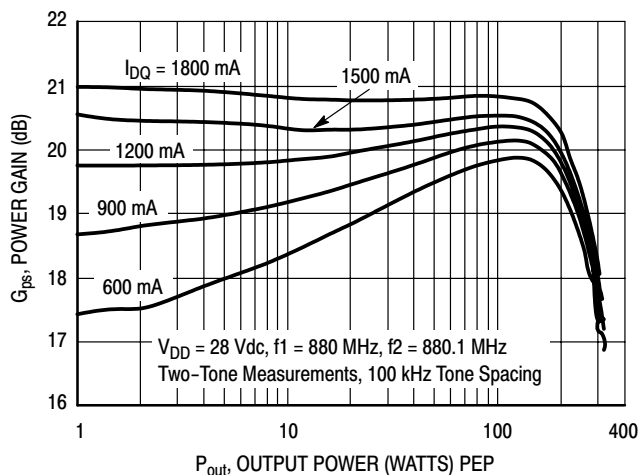

Figure 5. Two-Tone Power Gain versus Output Power

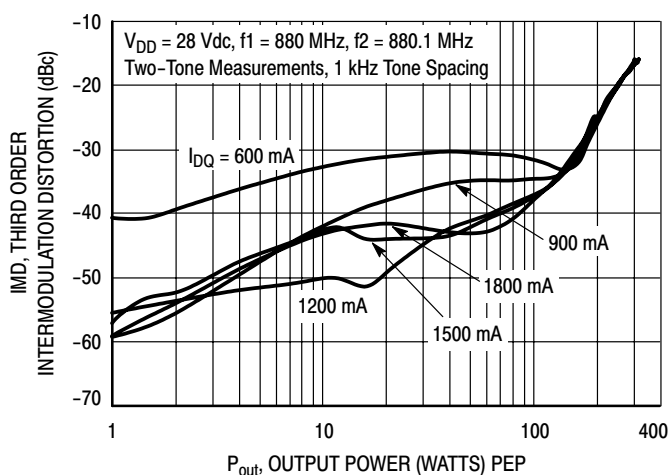

Figure 6. Third Order Intermodulation Distortion versus Output Power

## TYPICAL CHARACTERISTICS

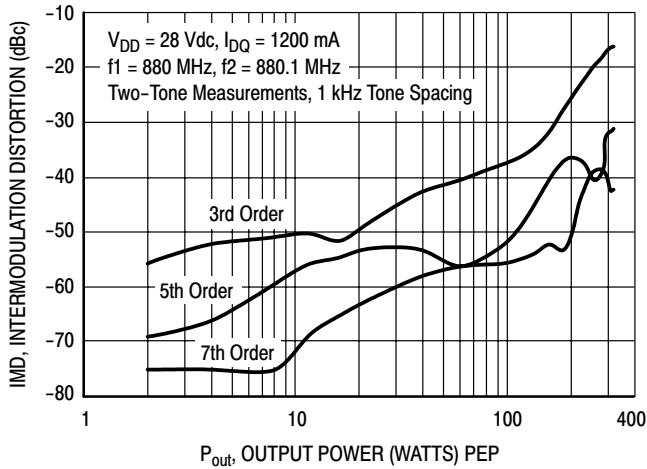

Figure 7. Intermodulation Distortion Products versus Output Power

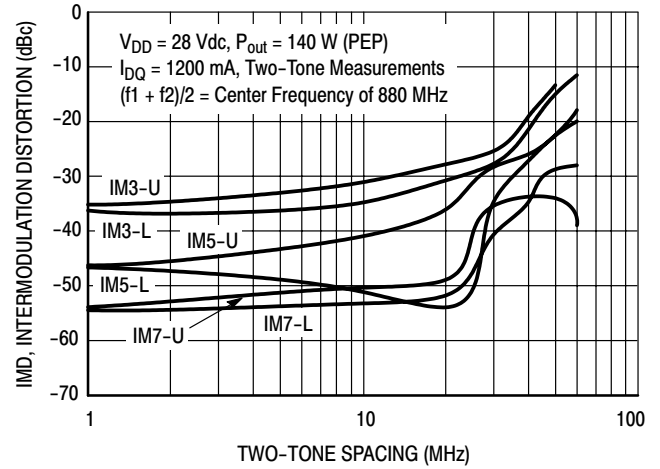

Figure 8. Intermodulation Distortion Products versus Tone Spacing

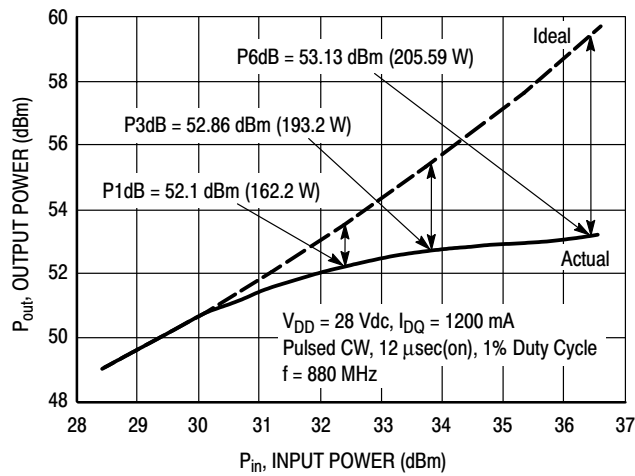

Figure 9. Pulsed CW Output Power versus Input Power

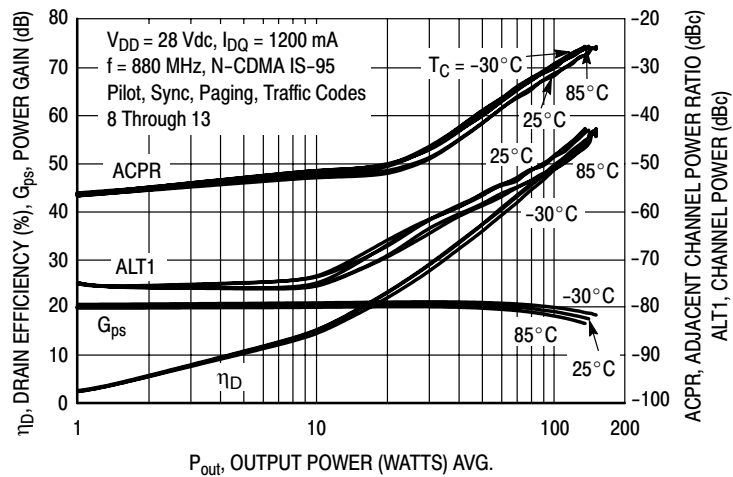
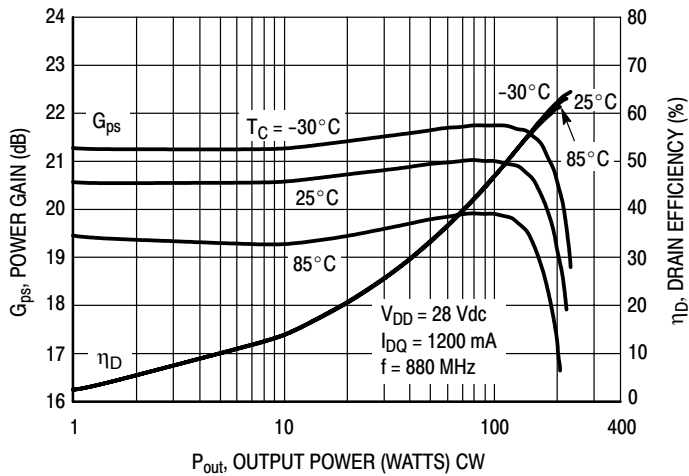
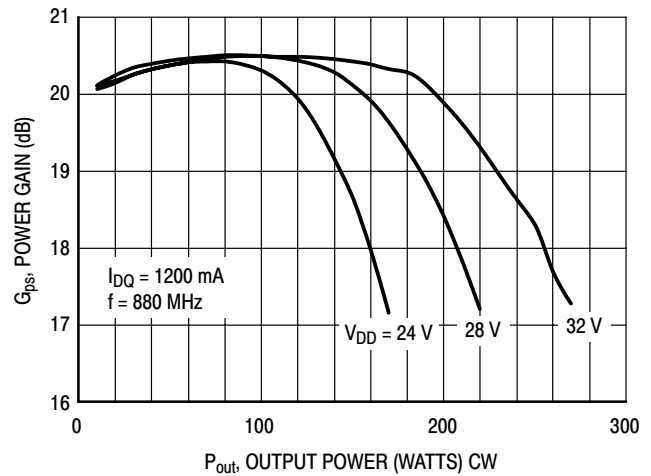

Figure 10. Single-Carrier N-CDMA ACPR, ALT1, Power Gain and Drain Efficiency versus Output Power

## TYPICAL CHARACTERISTICS



**Figure 11. Power Gain and Drain Efficiency versus CW Output Power**



**Figure 12. Power Gain versus Output Power**

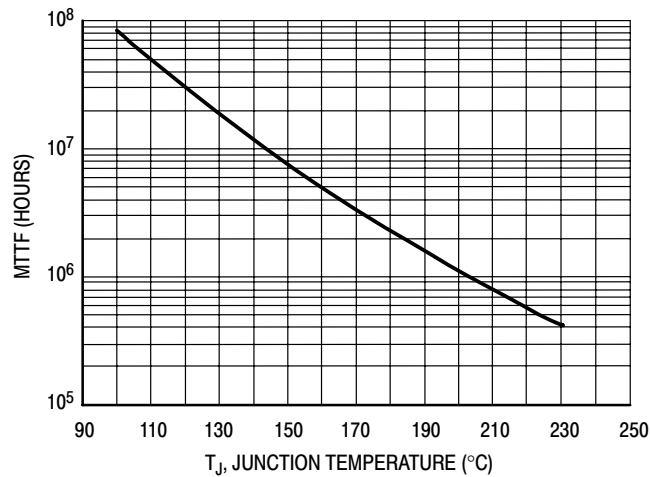

This above graph displays calculated MTTF in hours when the device is operated at  $V_{DD} = 28$  Vdc,  $P_{out} = 35$  W Avg., and  $\eta_D = 31\%$ .

MTTF calculator available at <http://www.freescale.com/rf>. Select Software & Tools/Development Tools/Calculators to access MTTF calculators by product.

**Figure 13. MTTF versus Junction Temperature**



## N-CDMA TEST SIGNAL

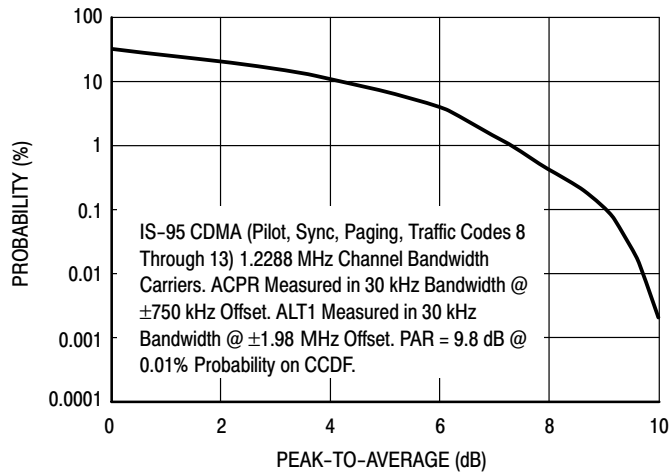

**Figure 14. Single-Carrier CCDF N-CDMA**

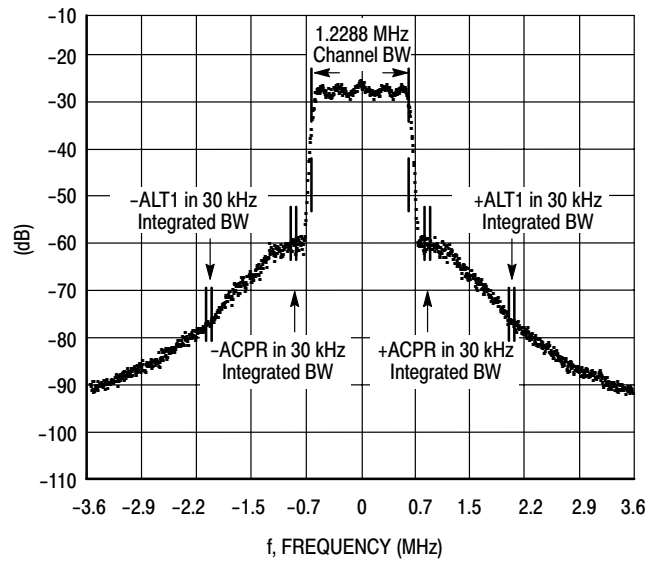

**Figure 15. Single-Carrier N-CDMA Spectrum**

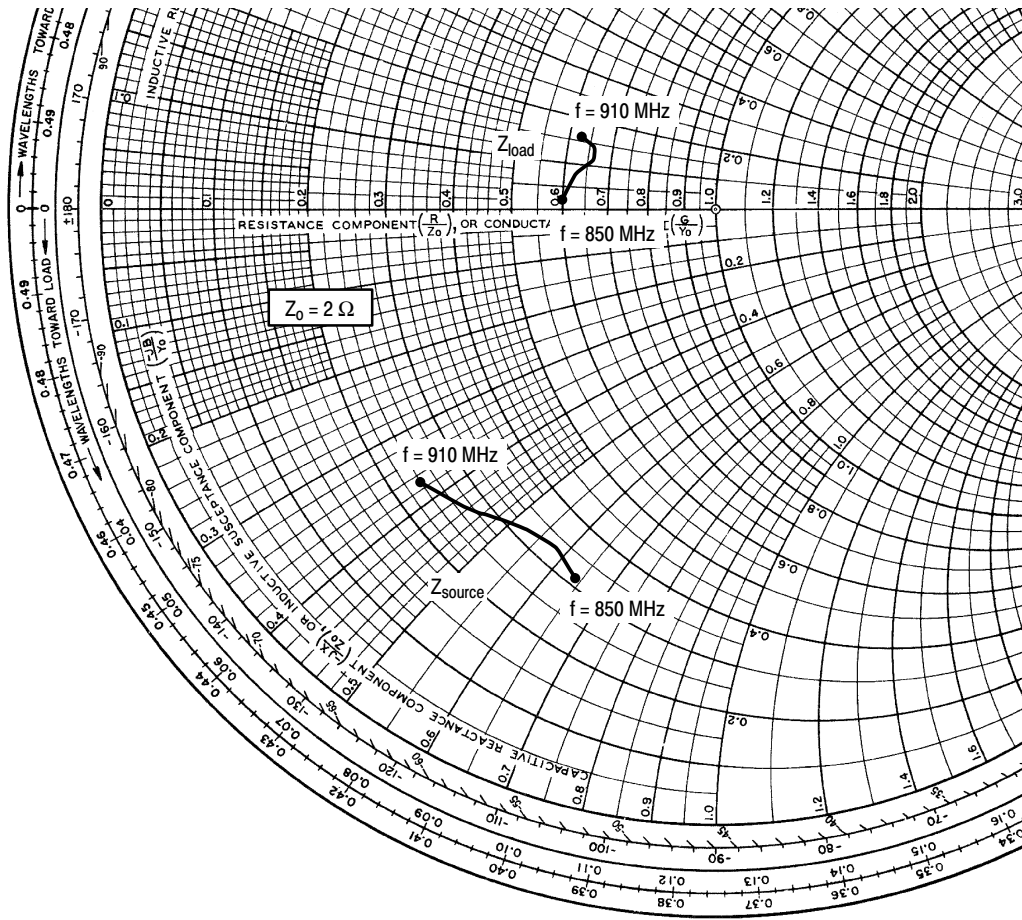

$V_{DD} = 28 \text{ Vdc}$ ,  $I_{DQ} = 1200 \text{ mA}$ ,  $P_{out} = 35 \text{ W Avg.}$

f MHz	$Z_{source}$ $\Omega$	$Z_{load}$ $\Omega$
850	$0.61 - j1.27$	$1.20 + j0.03$
865	$0.66 - j1.15$	$1.26 + j0.15$
880	$0.64 - j1.05$	$1.31 + j0.22$
895	$0.55 - j0.90$	$1.32 + j0.28$
910	$0.48 - j0.74$	$1.26 + j0.32$

$Z_{source}$  = Test circuit impedance as measured from gate to ground.

$Z_{load}$  = Test circuit impedance as measured from drain to ground.

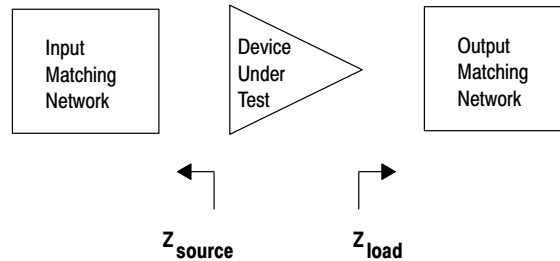
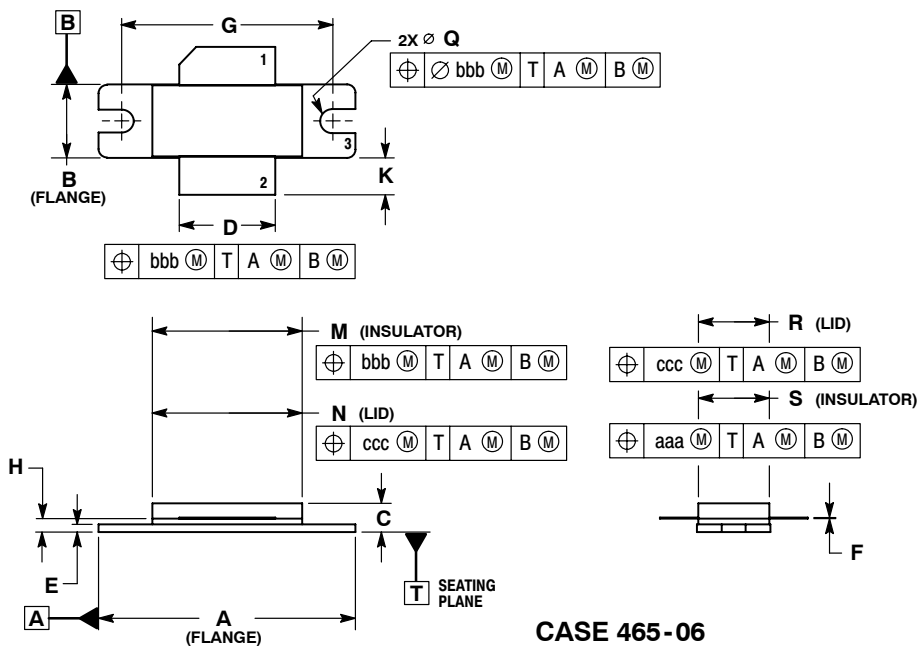

Figure 16. Series Equivalent Source and Load Impedance

## PACKAGE DIMENSIONS



- NOTES:
1. DIMENSIONING AND TOLERANCING PER ANSI Y14.5M-1994.
  2. CONTROLLING DIMENSION: INCH.
  3. DELETED
  4. DIMENSION H IS MEASURED 0.030 (0.762) AWAY FROM PACKAGE BODY.

DIM	INCHES		MILLIMETERS	
	MIN	MAX	MIN	MAX
A	1.335	1.345	33.91	34.16
B	0.380	0.390	9.65	9.91
C	0.125	0.170	3.18	4.32
D	0.495	0.505	12.57	12.83
E	0.035	0.045	0.89	1.14
F	0.003	0.006	0.08	0.15
G	1.100 BSC		27.94 BSC	
H	0.057	0.067	1.45	1.70
K	0.170	0.210	4.32	5.33
M	0.774	0.786	19.66	19.96
N	0.772	0.788	19.60	20.00
Q	$\varnothing$ 0.118	$\varnothing$ 0.138	$\varnothing$ 3.00	$\varnothing$ 3.51
R	0.365	0.375	9.27	9.53
S	0.365	0.375	9.27	9.52
aaa	0.005 REF		0.127 REF	
bbb	0.010 REF		0.254 REF	
ccc	0.015 REF		0.381 REF	

- STYLE 1:
1. DRAIN
  2. GATE
  3. SOURCE

**CASE 465-06  
ISSUE G  
NI-780  
MRFE6S9160HR3**

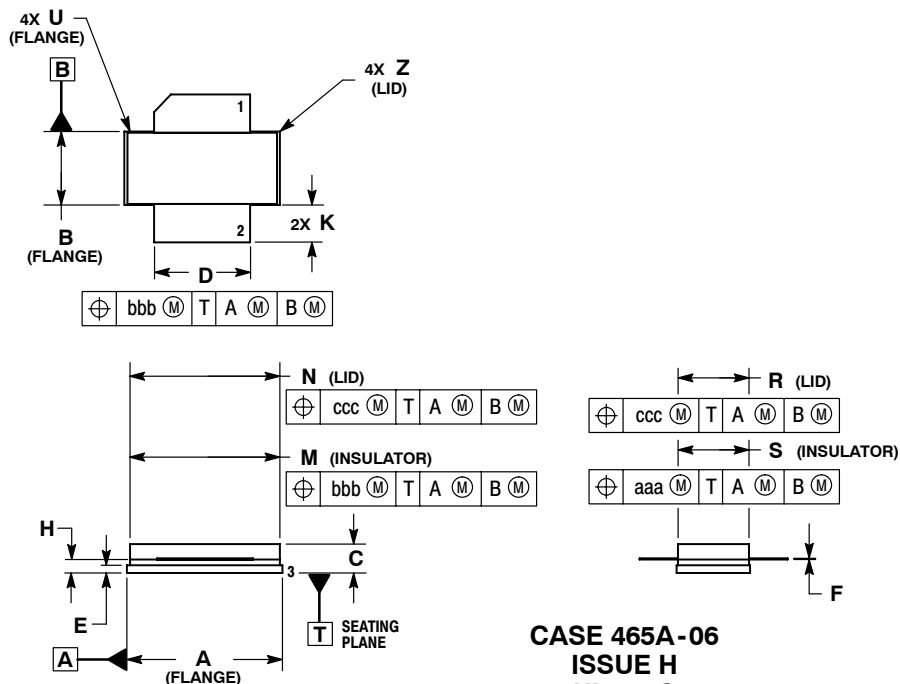

- NOTES:
1. DIMENSIONING AND TOLERANCING PER ANSI Y14.5M-1994.
  2. CONTROLLING DIMENSION: INCH.
  3. DELETED
  4. DIMENSION H IS MEASURED 0.030 (0.762) AWAY FROM PACKAGE BODY.

DIM	INCHES		MILLIMETERS	
	MIN	MAX	MIN	MAX
A	0.805	0.815	20.45	20.70
B	0.380	0.390	9.65	9.91
C	0.125	0.170	3.18	4.32
D	0.495	0.505	12.57	12.83
E	0.035	0.045	0.89	1.14
F	0.003	0.006	0.08	0.15
H	0.057	0.067	1.45	1.70
K	0.170	0.210	4.32	5.33
M	0.774	0.786	19.61	20.02
N	0.772	0.788	19.61	20.02
R	0.365	0.375	9.27	9.53
S	0.365	0.375	9.27	9.52
U	---	0.040	---	1.02
Z	---	0.030	---	0.76
aaa	0.005 REF		0.127 REF	
bbb	0.010 REF		0.254 REF	
ccc	0.015 REF		0.381 REF	

- STYLE 1:
1. DRAIN
  2. GATE
  3. SOURCE

**CASE 465A-06  
ISSUE H  
NI-780S  
MRFE6S9160HSR3**

## PRODUCT DOCUMENTATION

Refer to the following documents to aid your design process.

### Application Notes

- AN1955: Thermal Measurement Methodology of RF Power Amplifiers

### Engineering Bulletins

- EB212: Using Data Sheet Impedances for RF LDMOS Devices

## REVISION HISTORY

The following table summarizes revisions to this document.

Revision	Date	Description
0	Mar. 2007	<ul style="list-style-type: none"><li>• Initial Release of Data Sheet</li></ul>
1	Dec. 2008	<ul style="list-style-type: none"><li>• Table 4, On Characteristics, tightened <math>V_{DS(on)}</math> Min value from 0.05 to 0.1 to match production test values, p. 2</li><li>• Updated PCB information to show more specific material details, Fig. 1, Test Circuit Schematic, p. 4</li><li>• Updated Part Numbers in Table 5, Component Designations and Values, to latest RoHS compliant part numbers, p. 4</li><li>• Adjust scale for Fig. 8, Intermodulation Distortion Products versus Tone Spacing, to show wider dynamic range, p. 7</li></ul>

## **How to Reach Us:**

### **Home Page:**

[www.freescale.com](http://www.freescale.com)

### **Web Support:**

<http://www.freescale.com/support>

### **USA/Europe or Locations Not Listed:**

Freescale Semiconductor, Inc.  
Technical Information Center, EL516  
2100 East Elliot Road  
Tempe, Arizona 85284  
1-800-521-6274 or +1-480-768-2130  
[www.freescale.com/support](http://www.freescale.com/support)

### **Europe, Middle East, and Africa:**

Freescale Halbleiter Deutschland GmbH  
Technical Information Center  
Schatzbogen 7  
81829 Muenchen, Germany  
+44 1296 380 456 (English)  
+46 8 52200080 (English)  
+49 89 92103 559 (German)  
+33 1 69 35 48 48 (French)  
[www.freescale.com/support](http://www.freescale.com/support)

### **Japan:**

Freescale Semiconductor Japan Ltd.  
Headquarters  
ARCO Tower 15F  
1-8-1, Shimo-Meguro, Meguro-ku,  
Tokyo 153-0064  
Japan  
0120 191014 or +81 3 5437 9125  
[support.japan@freescale.com](mailto:support.japan@freescale.com)

### **Asia/Pacific:**

Freescale Semiconductor China Ltd.  
Exchange Building 23F  
No. 118 Jianguo Road  
Chaoyang District  
Beijing 100022  
China  
+86 10 5879 8000  
[support.asia@freescale.com](mailto:support.asia@freescale.com)

### **For Literature Requests Only:**

Freescale Semiconductor Literature Distribution Center  
P.O. Box 5405  
Denver, Colorado 80217  
1-800-441-2447 or +1-303-675-2140  
Fax: +1-303-675-2150  
[LDCForFreescaleSemiconductor@hibbertgroup.com](mailto:LDCForFreescaleSemiconductor@hibbertgroup.com)

Information in this document is provided solely to enable system and software implementers to use Freescale Semiconductor products. There are no express or implied copyright licenses granted hereunder to design or fabricate any integrated circuits or integrated circuits based on the information in this document.

Freescale Semiconductor reserves the right to make changes without further notice to any products herein. Freescale Semiconductor makes no warranty, representation or guarantee regarding the suitability of its products for any particular purpose, nor does Freescale Semiconductor assume any liability arising out of the application or use of any product or circuit, and specifically disclaims any and all liability, including without limitation consequential or incidental damages. "Typical" parameters that may be provided in Freescale Semiconductor data sheets and/or specifications can and do vary in different applications and actual performance may vary over time. All operating parameters, including "Typicals", must be validated for each customer application by customer's technical experts. Freescale Semiconductor does not convey any license under its patent rights nor the rights of others. Freescale Semiconductor products are not designed, intended, or authorized for use as components in systems intended for surgical implant into the body, or other applications intended to support or sustain life, or for any other application in which the failure of the Freescale Semiconductor product could create a situation where personal injury or death may occur. Should Buyer purchase or use Freescale Semiconductor products for any such unintended or unauthorized application, Buyer shall indemnify and hold Freescale Semiconductor and its officers, employees, subsidiaries, affiliates, and distributors harmless against all claims, costs, damages, and expenses, and reasonable attorney fees arising out of, directly or indirectly, any claim of personal injury or death associated with such unintended or unauthorized use, even if such claim alleges that Freescale Semiconductor was negligent regarding the design or manufacture of the part.

Freescale™ and the Freescale logo are trademarks of Freescale Semiconductor, Inc. All other product or service names are the property of their respective owners.

© Freescale Semiconductor, Inc. 2007-2008. All rights reserved.

