

Number of Contacts
9, 15, 21, 25, 31, 37

Filter Class
A, B, C, D, E, F or G
(See Table II)

Hardware Option
 NN - No Jackpost, No Threaded Insert
 PN - Jackpost, No Threaded Insert
 NU - Threaded Insert Only, No Jackposts
 PU - Jackpost and Threaded Insert

Rear Panel Jackposts with Threaded Insert:
 R6U - 0.125" (3.2) Panel
 R5U - 0.094" (2.4) Panel
 R4U - 0.062" (1.6) Panel
 R3U - 0.047" (1.2) Panel
 R2U - 0.031" (0.8) Panel

D

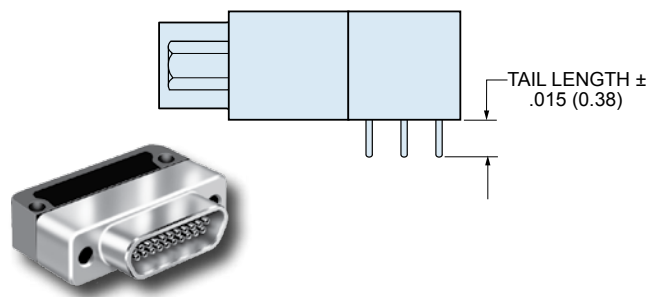
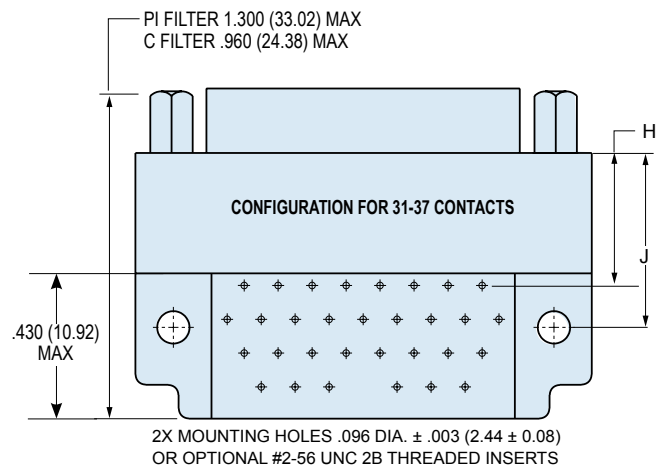
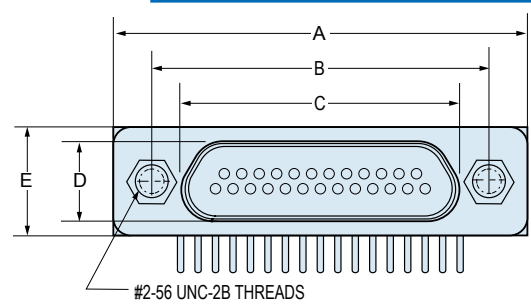
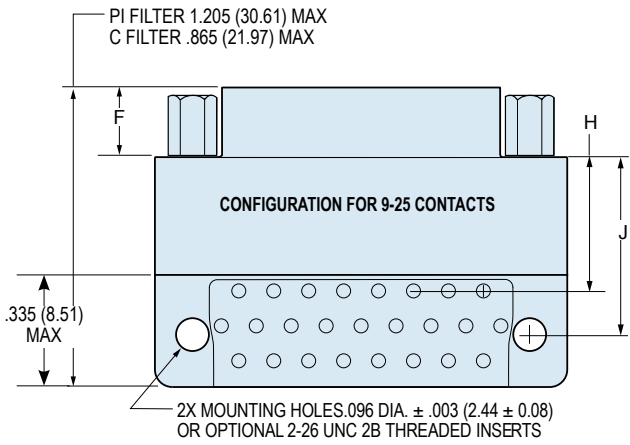

Right Angle Board Mount Filtered Micro-D's. These connectors feature low-pass EMI filtering in a right angle header for PCB termination.

.100" x .100" Board Spacing—These connectors are similar to "CBR" style Micro-D's and share the same board footprint, allowing retrofit to existing boards.

240-034
Micro-D Filter Connectors
Right Angle Printed Circuit Board



TABLE I: SHELL FINISH

SYM	MATERIAL	FINISH DESCRIPTION
1	Aluminum	Cadmium
2	Aluminum	Nickel
5	Aluminum	Gold
6	Aluminum	Chem Film
33	Aluminum	Ni-PTFE 1000 Hour Grey™

TABLE II: CAPACITOR ARRAY CODE CAPACITANCE RANGE*

CLASS	PI - CIRCUIT (pF)	C - CIRCUIT (pF)
A	38,000 - 56,000	19,000 - 28,000
B	32,000 - 45,000	16,000 - 22,500
C	18,000 - 33,000	9,000 - 16,500
D	8,000 - 12,000	4,000 - 6,000
E	3,300 - 5,000	1,650 - 2,500
F	800 - 1,300	400 - 650
G	400 - 600	200 - 300

MICRO-D FILTER CLASSES AND PERFORMANCE

Filter Class →	A	B	C	D	E	F	G									
Capacitance, Picofarads (pF)																
C Filter	19000-28000	16000-22500	9000-16500	4000-6000	1650-2500	400-650	200-300									
Pi Filter	38000-56000	32000-45000	18000-33000	8000-12000	3300-5000	800-1300	400-600									
Insertion Loss, dB Minimum, 25° C.																
Filter Type →	C		Pi		C		Pi		C		Pi		C		Pi	
1 MHz	6	10	5	8	3	5	—	1	—	—	—	—	—	—	—	—
10 MHz	24	40	23	35	16	25	8	14	4	8	—	2	—	—	—	0.8
100 MHz	41	62	39	60	35	57	28	50	21	40	10	15	5	13	—	—
500-1000 MHz	50	66	49	62	46	60	41	58	34	52	23	32	17	22	—	—

MICRO-D FILTER RIGHT ANGLE PCB CONNECTORS

Layout	A Max.		B		C Max.		D Max.		E Max.		F		G Max.		C Filter				Pi Filter			
	In.	mm.	In.	mm.	In.	mm.	In.	mm.	In.	mm.	In.	mm.	In.	mm.	H		J		H		J	
															±.010	±0.25	±.010	±0.25	±.010	±0.25	±.010	±0.25
9P	.785	19.94	.565	14.35	.333	8.46	.184	4.67	.310	7.87	.183	4.65	.420	10.67	.440	11.18	.460	11.68	.740	18.80	.760	19.30
9S	.785	19.94	.565	14.35	.400	10.16	.250	6.35	.310	7.87	.195	4.95	.420	10.67	.440	11.18	.460	11.68	.740	18.80	.760	19.30
15P	.935	23.75	.715	18.16	.483	12.27	.184	4.67	.310	7.87	.183	4.65	.420	10.67	.340	8.64	.460	11.68	.640	16.26	.760	19.30
15S	.935	23.75	.715	18.16	.551	14.00	.250	6.35	.310	7.87	.195	4.95	.420	10.67	.340	8.64	.460	11.68	.640	16.26	.760	19.30
21P	1.085	27.56	.865	21.97	.633	16.08	.184	4.67	.310	7.87	.183	4.65	.420	10.67	.340	8.64	.460	11.68	.640	16.26	.760	19.30
21S	1.085	27.56	.865	21.97	.701	17.81	.250	6.35	.310	7.87	.195	4.95	.420	10.67	.340	8.64	.460	11.68	.640	16.26	.760	19.30
25P	1.185	30.01	.965	24.51	.733	18.62	.184	4.67	.310	7.87	.183	4.65	.420	10.67	.340	8.64	.460	11.68	.640	16.26	.760	19.30
25S	1.185	30.01	.965	24.51	.801	20.35	.250	6.35	.310	7.87	.195	4.95	.420	10.67	.340	8.64	.460	11.68	.640	16.26	.760	19.30
31P	1.335	33.91	1.115	28.32	.883	22.43	.184	4.67	.310	7.87	.183	4.65	.520	13.21	.340	8.64	.460	11.68	.640	16.26	.760	19.30
31S	1.335	33.91	1.115	28.32	.951	24.16	.250	6.35	.310	7.87	.195	4.95	.520	13.21	.340	8.64	.460	11.68	.640	16.26	.760	19.30
37P	1.485	37.72	1.265	32.13	1.033	26.24	.184	4.67	.310	7.87	.183	4.65	.520	13.21	.340	8.64	.460	11.68	.640	16.26	.760	19.30
37S	1.485	37.72	1.265	32.13	1.101	27.96	.250	6.35	.310	7.87	.195	4.95	.520	13.21	.340	8.64	.460	11.68	.640	16.26	.760	19.30

PC Tail Diameter $.018 \pm .002$ (0.46 ± 0.05)
Contact numbers shown are for pin connectors.
Patterns shown are for connector mounting side of PC board.

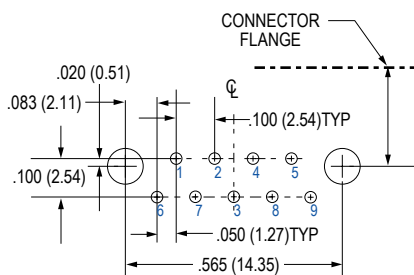

9 Contacts

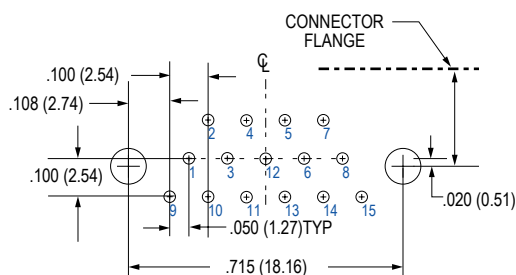

15 Contacts

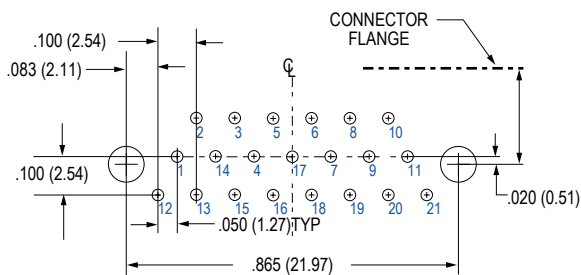

21 Contacts

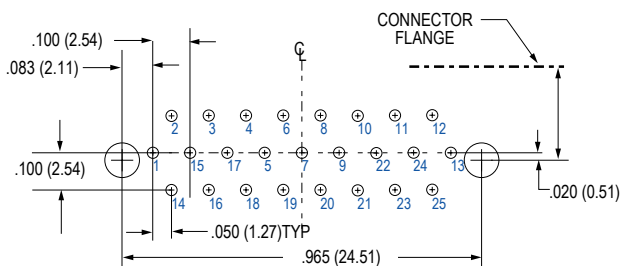

25 Contacts

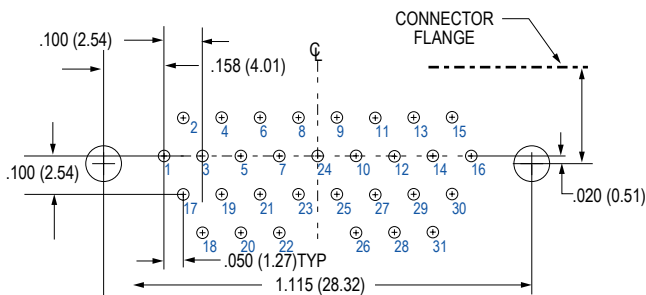

31 Contacts

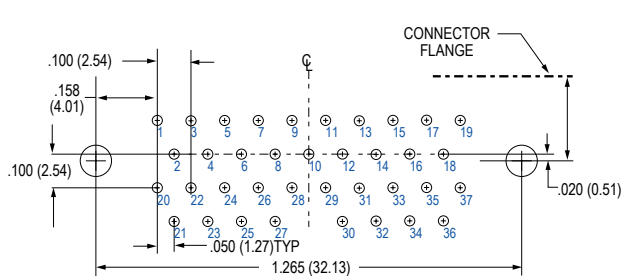

37 Contacts

240-034
Micro-D Filter Connectors
Right Angle Printed Circuit Board Layouts
Socket Connector



PC Tail Diameter $.018 \pm .002$ (0.46 ± 0.05)
Contact numbers shown are for socket connectors.
Patterns shown are for connector mounting side of PC board.

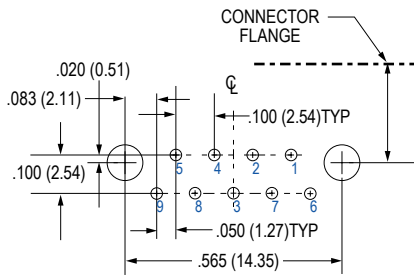

9 Contacts

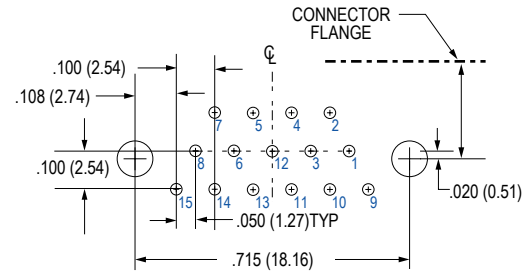

15 Contacts

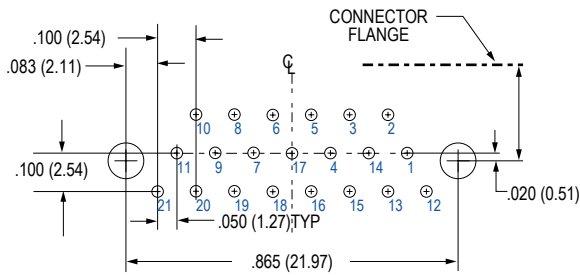

21 Contacts

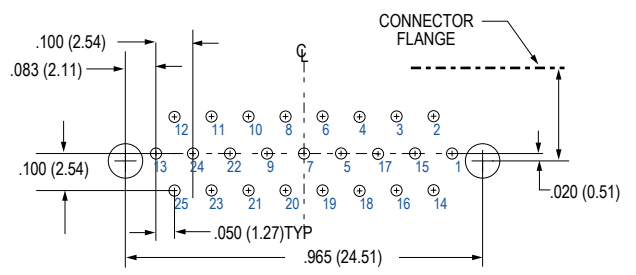

25 Contacts

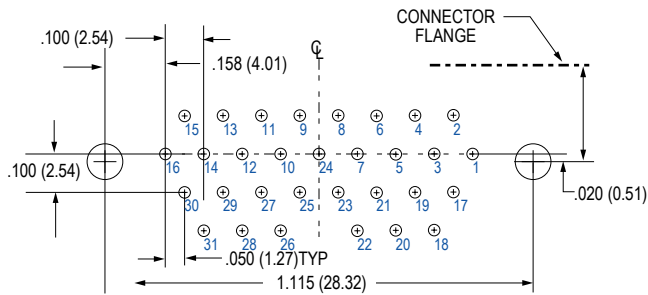

31 Contacts

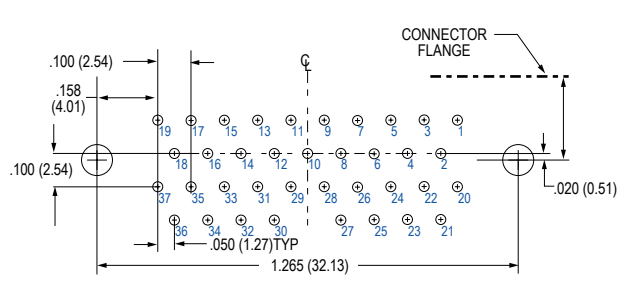

37 Contacts

