

# The RF MOSFET Line

## RF Power Field-Effect Transistor

### N-Channel Enhancement-Mode MOSFET

Designed for broadband commercial and military applications at frequencies to 175 MHz. The high power, high gain and broadband performance of this device makes possible solid state transmitters for FM broadcast or TV channel frequency bands.

- Guaranteed Performance at 30 MHz, 28 V:  
Output Power — 150 W  
Gain — 18 dB (22 dB Typ)  
Efficiency — 40%
- Typical Performance at 175 MHz, 50 V:  
Output Power — 150 W  
Gain — 13 dB
- Low Thermal Resistance
- Ruggedness Tested at Rated Output Power
- Nitride Passivated Die for Enhanced Reliability

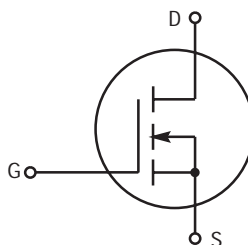

**MRF141**

**150 W, 28 V, 175 MHz**  
**N-CHANNEL**  
**BROADBAND**  
**RF POWER MOSFET**

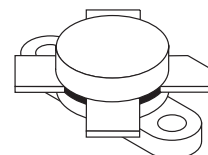

**CASE 211-11, STYLE 2**

#### MAXIMUM RATINGS

Rating	Symbol	Value	Unit
Drain-Source Voltage	$V_{DSS}$	65	Vdc
Drain-Gate Voltage	$V_{DGO}$	65	Vdc
Gate-Source Voltage	$V_{GS}$	$\pm 40$	Vdc
Drain Current — Continuous	$I_D$	16	Adc
Total Device Dissipation @ $T_C = 25^\circ\text{C}$ Derate above $25^\circ\text{C}$	$P_D$	300 1.71	Watts $W/^\circ\text{C}$
Storage Temperature Range	$T_{stg}$	-65 to +150	$^\circ\text{C}$
Operating Junction Temperature	$T_J$	200	$^\circ\text{C}$

#### THERMAL CHARACTERISTICS

Characteristic	Symbol	Max	Unit
Thermal Resistance, Junction to Case	$R_{\theta JC}$	0.6	$^\circ\text{C/W}$

NOTE — **CAUTION** — MOS devices are susceptible to damage from electrostatic charge. Reasonable precautions in handling and packaging MOS devices should be observed.

**ELECTRICAL CHARACTERISTICS** ( $T_C = 25^\circ\text{C}$  unless otherwise noted)

Characteristic	Symbol	Min	Typ	Max	Unit
<b>OFF CHARACTERISTICS (1)</b>					
Drain-Source Breakdown Voltage ( $V_{GS} = 0, I_D = 100 \text{ mA}$ )	$V_{(BR)DSS}$	65	—	—	Vdc
Zero Gate Voltage Drain Current ( $V_{DS} = 28 \text{ V}, V_{GS} = 0$ )	$I_{DSS}$	—	—	5.0	mAdc
Gate-Body Leakage Current ( $V_{GS} = 20 \text{ V}, V_{DS} = 0$ )	$I_{GSS}$	—	—	1.0	$\mu\text{Adc}$

**ON CHARACTERISTICS (1)**

Gate Threshold Voltage ( $V_{DS} = 10 \text{ V}, I_D = 100 \text{ mA}$ )	$V_{GS(th)}$	1.0	3.0	5.0	Vdc
Drain-Source On-Voltage ( $V_{GS} = 10 \text{ V}, I_D = 10 \text{ A}$ )	$V_{DS(on)}$	0.1	0.9	1.5	Vdc
Forward Transconductance ( $V_{DS} = 10 \text{ V}, I_D = 5.0 \text{ A}$ )	$g_{fs}$	5.0	7.0	—	mhos

**DYNAMIC CHARACTERISTICS (1)**

Input Capacitance ( $V_{DS} = 28 \text{ V}, V_{GS} = 0, f = 1.0 \text{ MHz}$ )	$C_{iss}$	—	350	—	pF
Output Capacitance ( $V_{DS} = 28 \text{ V}, V_{GS} = 0, f = 1.0 \text{ MHz}$ )	$C_{oss}$	—	420	—	pF
Reverse Transfer Capacitance ( $V_{DS} = 28 \text{ V}, V_{GS} = 0, f = 1.0 \text{ MHz}$ )	$C_{rss}$	—	35	—	pF

**FUNCTIONAL TESTS**

Common Source Amplifier Power Gain, $f = 30; 30.001 \text{ MHz}$ ( $V_{DD} = 28 \text{ V}, P_{out} = 150 \text{ W (PEP)}, I_{DQ} = 250 \text{ mA}$ ) $f = 175 \text{ MHz}$	$G_{ps}$	16 —	20 10	— —	dB
Drain Efficiency ( $V_{DD} = 28 \text{ V}, P_{out} = 150 \text{ W (PEP)}, f = 30; 30.001 \text{ MHz},$ $I_{DQ} = 250 \text{ mA}, I_D (\text{Max}) = 5.95 \text{ A}$ )	$\eta$	40	45	—	%
Intermodulation Distortion (1) ( $V_{DD} = 28 \text{ V}, P_{out} = 150 \text{ W (PEP)}, f = 30 \text{ MHz},$ $f_2 = 30.001 \text{ MHz}, I_{DQ} = 250 \text{ mA}$ )	$IMD_{(d3)}$ $IMD_{(d11)}$	— —	-30 -60	-28 —	dB
Load Mismatch ( $V_{DD} = 28 \text{ V}, P_{out} = 150 \text{ W (PEP)}, f_1 = 30; 30.001 \text{ MHz},$ $I_{DQ} = 250 \text{ mA}, \text{VSWR } 30:1 \text{ at all Phase Angles}$ )	$\psi$	No Degradation in Output Power			

**CLASS A PERFORMANCE**

Intermodulation Distortion (1) and Power Gain ( $V_{DD} = 28 \text{ V}, P_{out} = 50 \text{ W (PEP)}, f_1 = 30 \text{ MHz},$ $f_2 = 30.001 \text{ MHz}, I_{DQ} = 4.0 \text{ A}$ )	$G_{PS}$ $IMD_{(d3)}$ $IMD_{(d9-13)}$	— — —	23 -50 -75	— — —	dB
---	---	-------------	------------------	-------------	----

NOTE:

- To MIL-STD-1311 Version A, Test Method 2204B, Two Tone, Reference Each Tone.

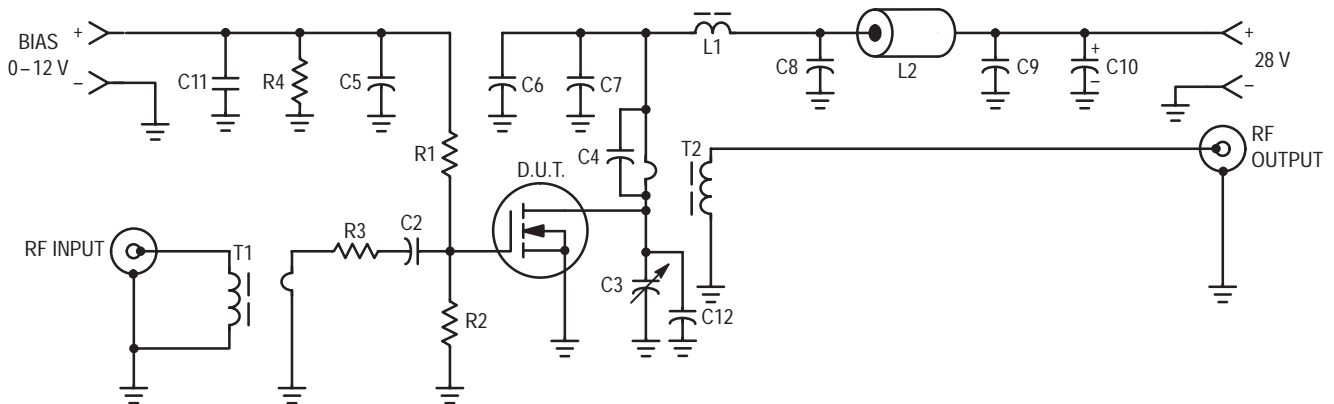

C2, C5, C6, C7, C8, C9 — 0.1  $\mu\text{F}$  Ceramic Chip or Monolithic with Short Leads

C3 — Arco 469

C4 — 820 pF Unencapsulated Mica or Dipped Mica with Short Leads

C10 — 10  $\mu\text{F}/100 \text{ V}$  Electrolytic

C11 — 1  $\mu\text{F}, 50 \text{ V}$ , Tantalum

C12 — 330 pF, Dipped Mica (Short leads)

L1 — VK200/4B Ferrite Choke or Equivalent, 3.0  $\mu\text{H}$

L2 — Ferrite Bead(s), 2.0  $\mu\text{H}$

R1, R2 — 51  $\Omega/1.0 \text{ W}$  Carbon

R3 — 1.0  $\Omega/1.0 \text{ W}$  Carbon or Parallel Two 2  $\Omega, 1/2 \text{ W}$  Resistors

R4 — 1  $\text{k}\Omega/1/2 \text{ W}$  Carbon

T1 — 16:1 Broadband Transformer

T2 — 1:25 Broadband Transformer

Board Material — 0.062" Fiberglass (G10),

1 oz. Copper Clad, 2 Sides,  $\epsilon_r = 5$

Figure 1. 30 MHz Test Circuit (Class AB)

## TYPICAL CHARACTERISTICS

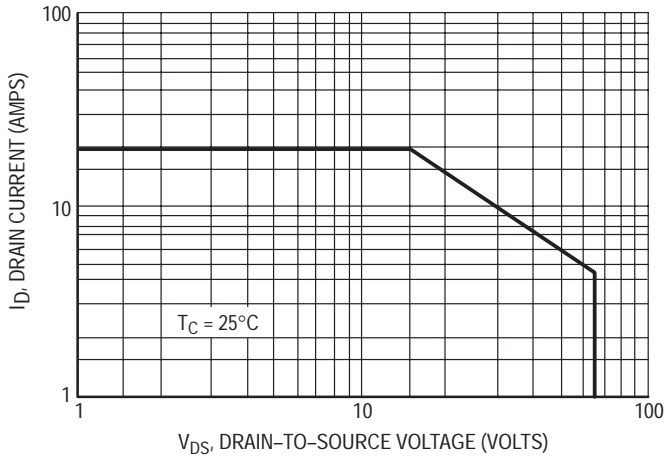

**Figure 2. DC Safe Operating Area**

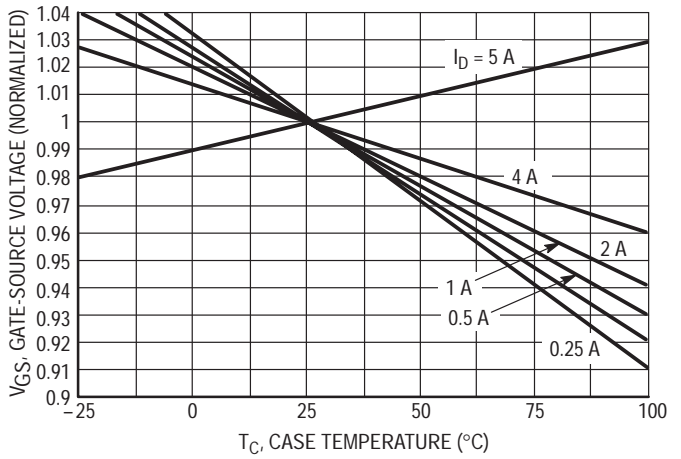

**Figure 3. Gate-Source Voltage versus Case Temperature**

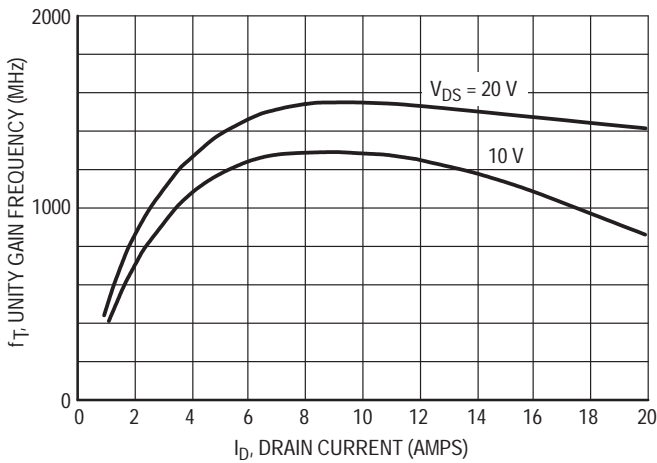

**Figure 4. Common Source Unity Gain Frequency versus Drain Current**

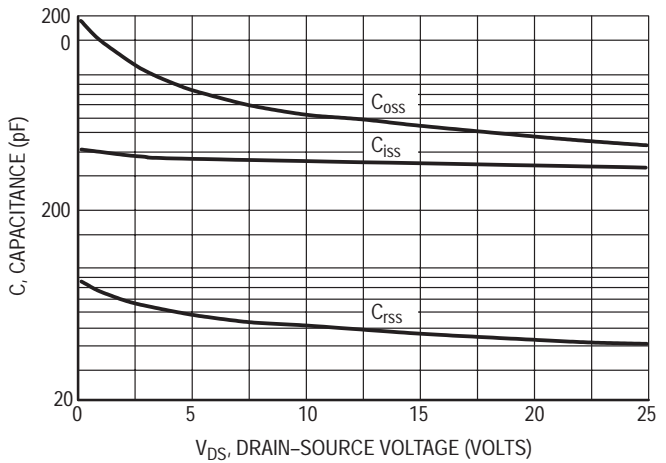

**Figure 5. Capacitance versus Drain-Source Voltage**

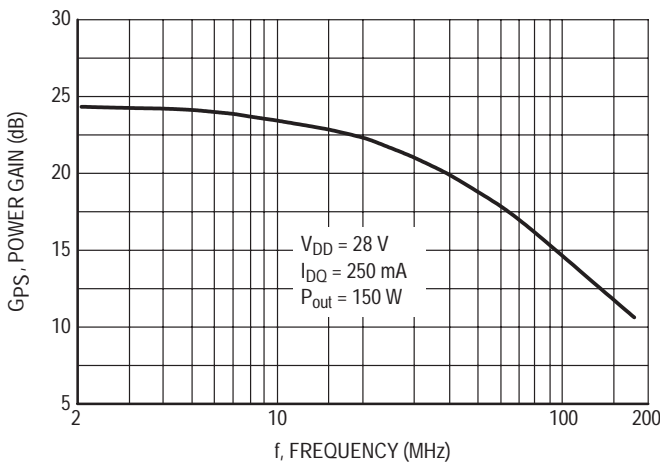

**Figure 6. Power Gain versus Frequency**

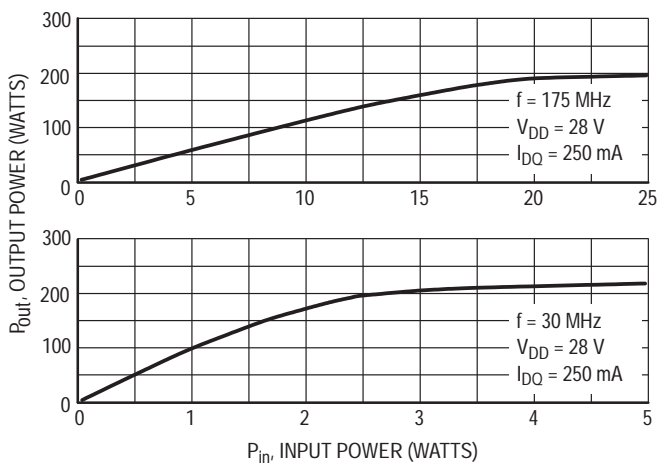

**Figure 7. Output Power versus Input Power**

www.DataSheet-PC.com

## TYPICAL CHARACTERISTICS

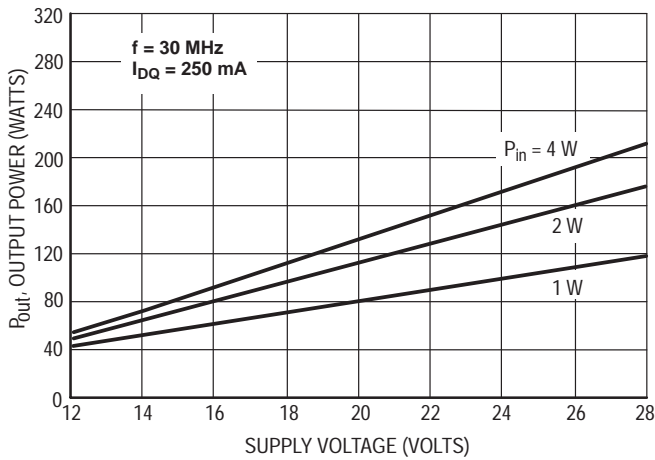

Figure 8. Output Power versus Supply Voltage

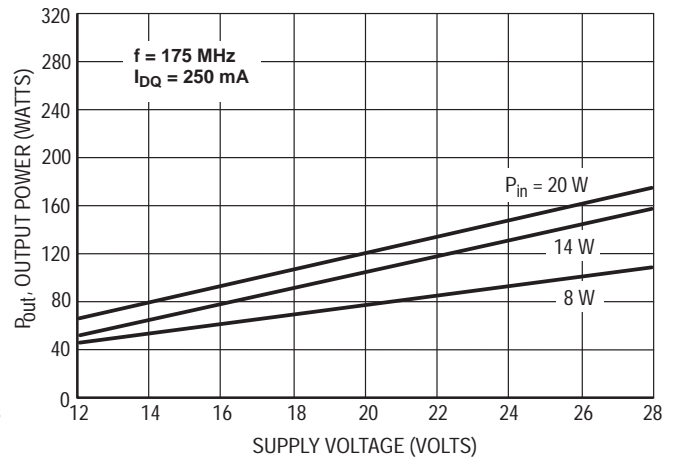

Figure 9. Output Power versus Supply Voltage

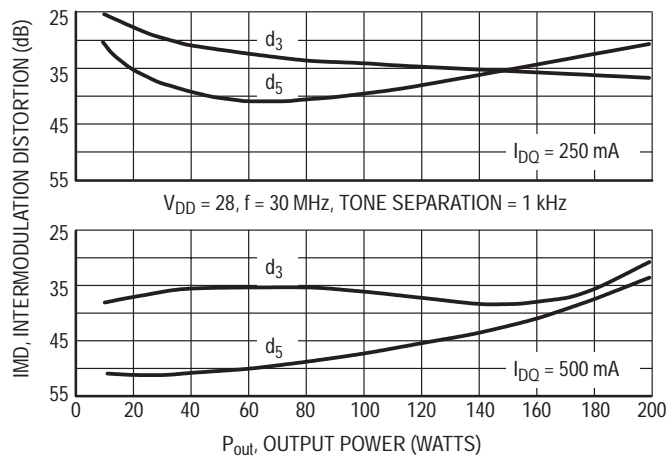

Figure 10. IMD versus P<sub>out</sub> (PEP)

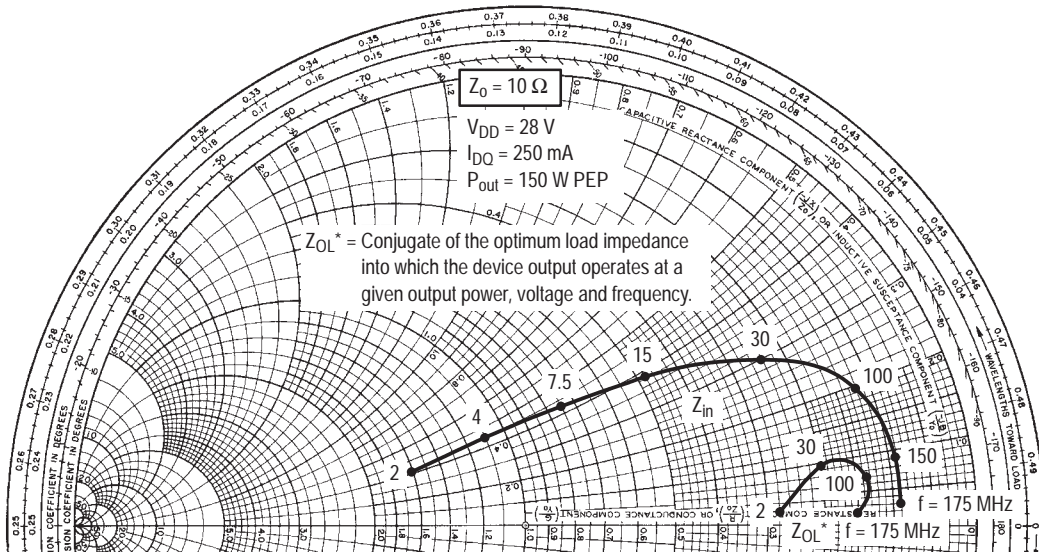
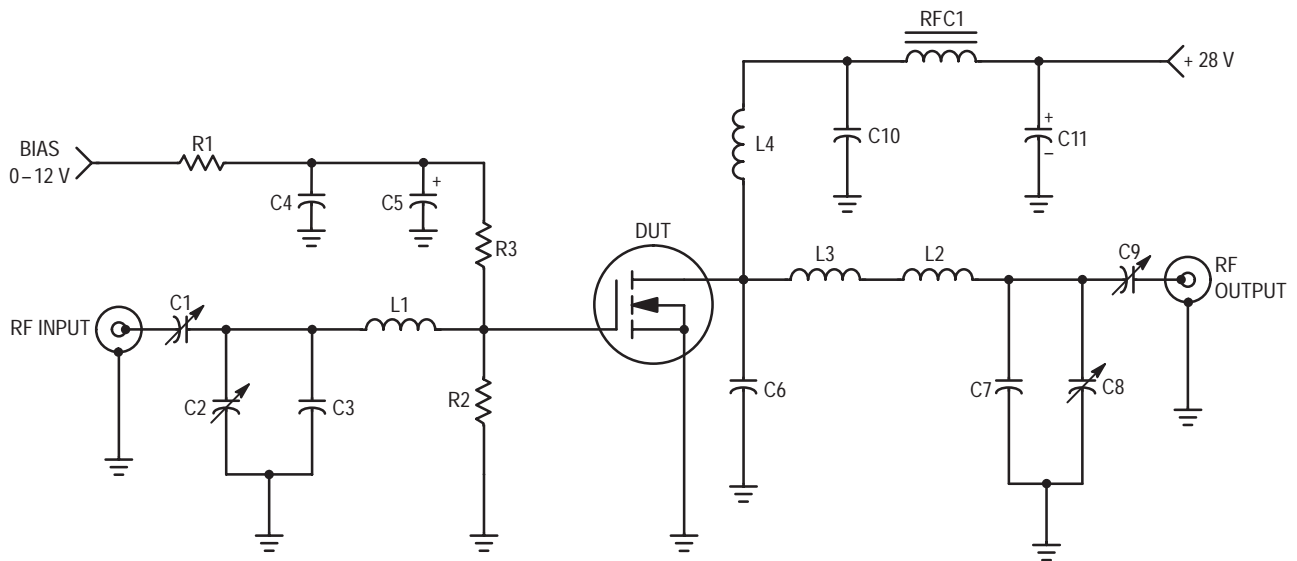

Figure 11. Input and Output Impedances



- C1, C2, C8 — Arco 463 or equivalent
- C3 — 25 pF, Unelco
- C4 — 0.1  $\mu$ F, Ceramic
- C5 — 1.0  $\mu$ F, 15 WV Tantalum
- C6 — 25 pF, Unelco J101
- C7 — 25 pF, Unelco J101
- C9 — Arco 262 or equivalent
- C10 — 0.05  $\mu$ F, Ceramic
- C11 — 15  $\mu$ F, 35 WV Electrolytic

- L1 — 3/4", #18 AWG into Hairpin
- L2 — Printed Line, 0.200" x 0.500"
- L3 — 7/8", #16 AWG into Hairpin
- L4 — 2 Turns, #16 AWG, 5/16 ID
- RFC1 — 5.6  $\mu$ H, Molded Choke
- RFC2 — VK200-4B
- R1 — 150  $\Omega$ , 1.0 W Carbon
- R2 — 10 k $\Omega$ , 1/2 W Carbon
- R3 — 120  $\Omega$ , 1/2 W Carbon

Figure 12. 175 MHz Test Circuit (Class AB)

Table 1. Common Source S-Parameters ( $V_{DS} = 24\text{ V}$ ,  $I_D = 5\text{ A}$ )

f MHz	S <sub>11</sub>		S <sub>21</sub>		S <sub>12</sub>		S <sub>22</sub>	
	S <sub>11</sub>	φ	S <sub>21</sub>	φ	S <sub>12</sub>	φ	S <sub>22</sub>	φ
30	0.916	-177	4.23	83	0.008	32	0.876	-177
40	0.919	-178	3.23	76	0.009	39	0.885	178
50	0.922	-178	2.55	72	0.010	45	0.914	-180
60	0.923	-179	2.14	68	0.010	46	0.893	179
70	0.927	-179	1.77	63	0.011	48	0.878	179
80	0.929	-179	1.48	61	0.013	53	0.864	180
90	0.931	-180	1.28	60	0.015	61	0.850	180
100	0.934	-180	1.15	55	0.016	66	0.893	178
110	0.935	180	1.05	53	0.016	69	0.913	177
120	0.939	180	0.91	51	0.017	69	0.930	180
130	0.941	179	0.82	48	0.019	67	0.916	-180
140	0.943	179	0.76	46	0.022	68	0.926	179
150	0.946	179	0.67	42	0.024	70	0.940	177
160	0.946	179	0.63	40	0.025	73	0.915	178
170	0.948	178	0.57	39	0.024	78	0.891	178
180	0.949	178	0.52	37	0.026	75	0.906	178
190	0.950	178	0.49	37	0.028	74	0.899	176
200	0.950	177	0.45	35	0.030	78	0.915	176
210	0.938	177	0.43	31	0.043	108	0.966	174
220	0.958	178	0.39	33	0.029	61	0.972	175
230	0.961	177	0.36	27	0.038	77	1.033	174
240	0.960	177	0.36	28	0.036	76	0.943	174
250	0.961	176	0.32	30	0.038	77	0.912	175
260	0.962	176	0.30	31	0.040	76	0.918	174
270	0.961	176	0.27	30	0.044	77	0.933	171
280	0.963	176	0.26	30	0.045	79	0.943	172
290	0.964	175	0.25	25	0.045	78	0.940	172
300	0.965	175	0.26	27	0.047	77	0.930	172
310	0.966	175	0.25	27	0.051	78	0.977	172
320	0.964	175	0.24	26	0.053	75	0.947	171
330	0.966	174	0.22	21	0.056	75	0.946	170
340	0.967	174	0.23	26	0.056	75	0.944	170
350	0.967	174	0.22	24	0.058	78	0.946	171
360	0.965	174	0.21	28	0.062	74	0.956	171
370	0.966	174	0.20	28	0.048	61	0.968	170
380	0.968	173	0.20	27	0.053	74	0.931	168
390	0.970	173	0.18	31	0.063	74	0.962	168
400	0.970	173	0.17	26	0.071	79	0.965	172
410	0.970	172	0.17	29	0.076	78	0.982	169
420	0.971	172	0.17	30	0.076	76	0.956	167
430	0.970	172	0.15	29	0.070	76	0.912	165
440	0.970	171	0.13	32	0.074	76	0.933	167

Table 1. Common Source S-Parameters ( $V_{DS} = 24\text{ V}$ ,  $I_D = 5\text{ A}$ ) continued

f MHz	S <sub>11</sub>		S <sub>21</sub>		S <sub>12</sub>		S <sub>22</sub>	
	S <sub>11</sub>	φ	S <sub>21</sub>	φ	S <sub>12</sub>	φ	S <sub>22</sub>	φ
450	0.970	171	0.15	31	0.081	76	0.967	167
460	0.970	171	0.15	32	0.090	73	0.982	164
470	0.969	170	0.15	30	0.095	77	0.945	165
480	0.964	170	0.16	34	0.099	80	0.956	165
490	0.960	170	0.15	31	0.107	75	0.947	163
500	0.959	170	0.15	23	0.103	68	0.962	163

Table 2. Common Source S-Parameters ( $V_{DS} = 28\text{ V}$ ,  $I_D = 5\text{ A}$ )

f MHz	S <sub>11</sub>		S <sub>21</sub>		S <sub>12</sub>		S <sub>22</sub>	
	S <sub>11</sub>	φ	S <sub>21</sub>	φ	S <sub>12</sub>	φ	S <sub>22</sub>	φ
30	0.914	-177	4.60	82	0.007	25	0.874	-176
40	0.915	-178	3.51	76	0.008	26	0.879	-179
50	0.918	-178	2.76	71	0.009	34	0.888	-179
60	0.920	-178	2.32	67	0.010	45	0.881	179
70	0.924	-179	1.92	62	0.010	56	0.887	179
80	0.927	-179	1.61	60	0.009	62	0.899	-179
90	0.930	-179	1.39	58	0.010	61	0.874	-177
100	0.933	-180	1.23	53	0.012	57	0.875	-179
110	0.934	-180	1.13	51	0.015	63	0.884	179
120	0.938	180	0.98	49	0.017	73	0.926	179
130	0.940	180	0.88	46	0.018	81	0.959	-179
140	0.942	179	0.81	44	0.018	82	0.966	-179
150	0.945	179	0.71	40	0.018	77	0.961	-179
160	0.946	179	0.67	38	0.021	73	0.910	-179
170	0.948	178	0.61	37	0.023	77	0.871	179
180	0.950	178	0.54	35	0.026	78	0.912	178
190	0.950	178	0.52	34	0.029	76	0.959	177
200	0.952	178	0.47	33	0.034	64	0.971	178
210	0.949	177	0.46	28	0.067	17	1.023	-178
220	0.953	178	0.41	31	0.019	94	0.954	177
230	0.959	177	0.38	26	0.037	76	1.014	174
240	0.960	177	0.37	25	0.040	79	0.943	174
250	0.961	177	0.33	27	0.042	84	0.972	175
260	0.962	176	0.30	27	0.041	86	0.969	176
270	0.961	176	0.29	27	0.041	83	0.951	175
280	0.963	176	0.27	27	0.042	80	0.929	174
290	0.964	175	0.26	23	0.045	79	0.930	172
300	0.965	175	0.27	25	0.051	81	0.963	171
310	0.966	175	0.26	24	0.052	83	1.012	173
320	0.965	175	0.25	23	0.053	81	0.984	171
330	0.966	174	0.23	19	0.055	78	0.955	172
340	0.967	174	0.24	25	0.054	76	0.929	171
350	0.967	174	0.22	22	0.057	79	0.917	170

Table 2. Common Source S-Parameters ( $V_{DS} = 28\text{ V}$ ,  $I_D = 5\text{ A}$ ) continued

f MHz	S <sub>11</sub>		S <sub>21</sub>		S <sub>12</sub>		S <sub>22</sub>	
	S <sub>11</sub>	φ	S <sub>21</sub>	φ	S <sub>12</sub>	φ	S <sub>22</sub>	φ
360	0.967	174	0.21	26	0.060	91	0.978	169
370	0.967	174	0.20	26	0.084	89	1.030	167
380	0.969	173	0.20	23	0.081	82	0.994	170
390	0.970	173	0.19	29	0.072	80	0.963	170
400	0.970	173	0.17	25	0.069	80	0.951	172
410	0.970	172	0.17	27	0.072	71	0.985	167
420	0.972	172	0.16	28	0.078	68	0.970	165
430	0.971	172	0.15	27	0.084	70	0.953	165
440	0.971	171	0.13	29	0.086	74	0.949	168
450	0.971	171	0.15	29	0.087	79	0.962	167
460	0.970	171	0.15	32	0.081	72	0.976	164
470	0.969	170	0.15	29	0.079	65	0.969	164
480	0.964	170	0.16	32	0.081	57	0.972	165
490	0.959	170	0.15	29	0.081	54	0.976	165
500	0.958	170	0.15	21	0.086	58	0.953	167

## RF POWER MOSFET CONSIDERATIONS

### MOSFET CAPACITANCES

The physical structure of a MOSFET results in capacitors between the terminals. The metal anode gate structure determines the capacitors from gate-to-drain ( $C_{gd}$ ), and gate-to-source ( $C_{gs}$ ). The PN junction formed during the fabrication of the MOSFET results in a junction capacitance from drain-to-source ( $C_{ds}$ ).

These capacitances are characterized as input ( $C_{iss}$ ), output ( $C_{oss}$ ) and reverse transfer ( $C_{rss}$ ) capacitances on data sheets. The relationships between the inter-terminal capacitances and those given on data sheets are shown below. The  $C_{iss}$  can be specified in two ways:

1. Drain shorted to source and positive voltage at the gate.
2. Positive voltage of the drain in respect to source and zero volts at the gate. In the latter case the numbers are lower. However, neither method represents the actual operating conditions in RF applications.

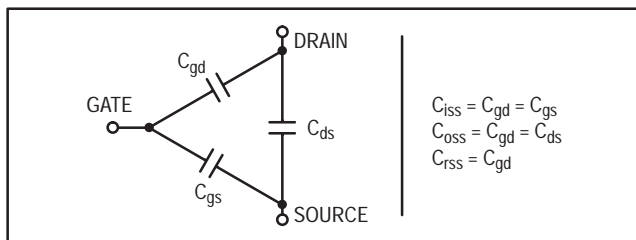

### LINEARITY AND GAIN CHARACTERISTICS

In addition to the typical IMD and power gain data presented, Figure 4 may give the designer additional information on the capabilities of this device. The graph represents the small signal unity current gain frequency at a given drain current level. This is equivalent to  $f_T$  for bipolar transistors.

REV 9

Since this test is performed at a fast sweep speed, heating of the device does not occur. Thus, in normal use, the higher temperatures may degrade these characteristics to some extent.

### DRAIN CHARACTERISTICS

One figure of merit for a FET is its static resistance in the full-on condition. This on-resistance,  $V_{DS(on)}$ , occurs in the linear region of the output characteristic and is specified under specific test conditions for gate-source voltage and drain current. For MOSFETs,  $V_{DS(on)}$  has a positive temperature coefficient and constitutes an important design consideration at high temperatures, because it contributes to the power dissipation within the device.

### GATE CHARACTERISTICS

The gate of the MOSFET is a polysilicon material, and is electrically isolated from the source by a layer of oxide. The input resistance is very high — on the order of  $10^9$  ohms — resulting in a leakage current of a few nanoamperes.

Gate control is achieved by applying a positive voltage slightly in excess of the gate-to-source threshold voltage,  $V_{GS(th)}$ .

**Gate Voltage Rating** — Never exceed the gate voltage rating. Exceeding the rated  $V_{GS}$  can result in permanent damage to the oxide layer in the gate region.

**Gate Termination** — The gate of this device is essentially capacitor. Circuits that leave the gate open-circuited or floating should be avoided. These conditions can result in turn-on of the device due to voltage build-up on the input capacitor due to leakage currents or pickup.

**Gate Protection** — This device does not have an internal monolithic zener diode from gate-to-source. If gate protection is required, an external zener diode is recommended.



Using a resistor to keep the gate-to-source impedance low also helps damp transients and serves another important function. Voltage transients on the drain can be coupled to the gate through the parasitic gate-drain capacitance. If the gate-to-source impedance and the rate of voltage change on the drain are both high, then the signal coupled to the gate may be large enough to exceed the gate-threshold voltage and turn the device on.

#### **HANDLING CONSIDERATIONS**

When shipping, the devices should be transported only in antistatic bags or conductive foam. Upon removal from the packaging, careful handling procedures should be adhered to. Those handling the devices should wear grounding straps and devices not in the antistatic packaging should be kept in metal tote bins. MOSFETs should be handled by the case and not by the leads, and when testing the device, all leads should make good electrical contact before voltage is applied. As a final note, when placing the FET into the system it is designed for, soldering should be done with a grounded iron.

#### **DESIGN CONSIDERATIONS**

The MRF141 is an RF Power, MOS, N-channel enhancement mode field-effect transistor (FET) designed for HF and VHF power amplifier applications.

M/A-COM Application Note AN211A, FETs in Theory and Practice, is suggested reading for those not familiar with the construction and characteristics of FETs.

The major advantages of RF power MOSFETs include high gain, low noise, simple bias systems, relative immunity from thermal runaway, and the ability to withstand severely mismatched loads without suffering damage. Power output can be varied over a wide range with a low power dc control signal.

#### **DC BIAS**

The MRF141 is an enhancement mode FET and, therefore, does not conduct when drain voltage is applied. Drain current flows when a positive voltage is applied to the gate. RF power FETs require forward bias for optimum performance. The value of quiescent drain current ( $I_{DQ}$ ) is not critical for many applications. The MRF141 was characterized at  $I_{DQ} = 250$  mA, each side, which is the suggested minimum value of  $I_{DQ}$ . For special applications such as linear amplification,  $I_{DQ}$  may have to be selected to optimize the critical parameters.

The gate is a dc open circuit and draws no current. Therefore, the gate bias circuit may be just a simple resistive divider network. Some applications may require a more elaborate bias system.

#### **GAIN CONTROL**

Power output of the MRF141 may be controlled from its rated value down to zero (negative gain) by varying the dc gate voltage. This feature facilitates the design of manual gain control, AGC/ALC and modulation systems.

## PACKAGE DIMENSIONS

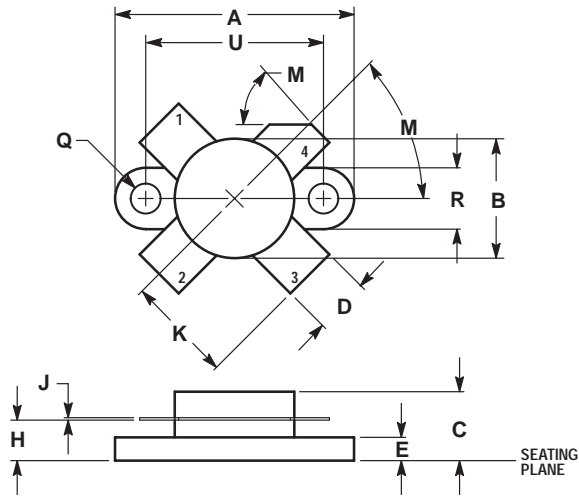

- NOTES:  
 1. DIMENSIONING AND TOLERANCING PER ANSI Y14.5M, 1982.  
 2. CONTROLLING DIMENSION: INCH.

DIM	INCHES		MILLIMETERS	
	MIN	MAX	MIN	MAX
A	0.960	0.990	24.39	25.14
B	0.465	0.510	11.82	12.95
C	0.229	0.275	5.82	6.98
D	0.216	0.235	5.49	5.96
E	0.084	0.110	2.14	2.79
H	0.144	0.178	3.66	4.52
J	0.003	0.007	0.08	0.17
K	0.435	---	11.05	---
M	45° NOM		45° NOM	
Q	0.115	0.130	2.93	3.30
R	0.246	0.255	6.25	6.47
U	0.720	0.730	18.29	18.54

- STYLE 2:  
 PIN 1. SOURCE  
 2. GATE  
 3. SOURCE  
 4. DRAIN

**CASE 211-11  
 ISSUE N**

*Specifications subject to change without notice.*

- **North America:** Tel. (800) 366-2266, Fax (800) 618-8883
- **Asia/Pacific:** Tel. +81-44-844-8296, Fax +81-44-844-8298
- **Europe:** Tel. +44 (1344) 869 595, Fax+44 (1344) 300 020

Visit [www.macom.com](http://www.macom.com) for additional data sheets and product information.

REV 9

**tyco** / Electronics

**MACOM**