

N-Series Motors Brushless Servo Motors

N-2302-1, N-2304-1,

N-3406-2, N-3412-2,

N-4214-2, N-4220-2,

N-5630-2, N-5637-2,

N-5647-2



Electro-Craft Motion Control
6950 Washington Avenue South
Eden Prairie, MN 55344
612-942-3600

www.DataSheet4U.com

THE RIGHT COMPANY. THE RIGHT SOLUTION.

Use of Motors

Servo motors are intended to drive machinery. As such, they must be part of a controlled system that includes a transistorized electronic amplifier. They are not intended for direct connection to the power supply or for use with thyristor drives. Instructions in the amplifier and control system manuals must be observed; this document does not replace those instructions.

Unless specified otherwise, servo motors are intended for use in a normal industrial environment without exposure to excessive or corrosive moisture or abnormal ambient temperatures. The exact operating conditions may be established by referring to the data for the motor. The mating of motors to machinery is a skilled operation; disassembly or repair must not be attempted. In the event that a motor fails to operate correctly, contact the place of purchase for return instructions.

Safety Notes

There are some possible hazards associated with the use of motors. The following precautions should be observed. Specific Warnings and Cautions are listed inside the back cover.

Installation and Maintenance: Installation and maintenance or replacement must be carried out by suitably qualified service personnel, paying particular attention to possible electrical and mechanical hazards.

Weight: Large motors are generally heavy, and the center of gravity may be offset. When handling, take appropriate precautions and use suitable lifting equipment. Beware of sharp edges; use protective gloves when handling such assemblies.

Flying leads: Ensure that flying or loose leads are suitably restrained, to prevent snagging or entanglement, before carrying motors with such leads.

Generation: If the motor is driven mechanically, it may generate hazardous voltages at its power input terminals. The power connector must be suitably guarded to prevent a possible shock hazard.

Loose motors: When running an unmounted motor, ensure that the rotating shaft is adequately guarded and the motor is physically restrained to prevent it from moving. Remove the key which otherwise could fly out when the motor is running.

Damaged cables: Damage to cables or connectors may cause an electrical hazard. Ensure there is no damage before energizing the system.

Supply: Servo motors must not be directly connected to a power supply; they require an electronic drive system. Consult the instructions for the drive system before energizing or using the motor.

Brakes: The brakes that are included on motors are holding brakes only and are not to be used as a mechanical restraining device for safety purposes.

Safety requirements: The safe incorporation of this product into a machine system is the responsibility of the machine designer, who should comply with the local safety requirements at the place where the machine is to be used. In Europe this is likely to be the Machinery Directive.

Mechanical connection: Motors must be connected to the machine with a torsionally rigid coupler or a reinforced timing belt. Couplers which are not rigid will cause difficulty in achieving an acceptable response from the control system. Couplings and pulleys must be tight as the high dynamic performance of a servo motor can easily cause couplings to slip, and thereby damage the shaft and cause instability. Care must be taken in aligning couplings and tightening belts so that the motor is not subjected to significant bearing loads, or premature bearing wear will occur. Once connected to a load, tuning will be affected. A system tuned without a load will probably require retuning once a load is applied.

Connectors: Motor power connectors are for assembly purposes only. They should not be connected or disconnected while power is applied.

© 1999 Rockwell International Corporation. All rights reserved.

Electro-Craft is a trademark of Rockwell Automation.

Printed in the United States of America.

Information contained in this manual is subject to change without notice.

www.DataSheet4U.com

Motor Data

MOTOR		N-2302-1	N-2304-1	N-3406-2	N-3412-2	N-4214-2	N-4220-2
MECHANICAL DATA (1)							
Rotor Moment of Inertia	kg-m ²	0.000009	0.00002	0.00008	0.00015	0.00024	0.00035
	lb-in-s ²	0.00008	0.00016	0.0007	0.0013	0.0021	0.0031
Rotor Moment of Inertia Motors W/Brake	kg-m ²	0.000018	0.000032	0.000122	0.000202	0.000210	0.000320
	lb-in-s ²	0.00016	0.00028	0.00108	0.00179	0.00186	0.00283
Motor Weight: Net	kg/lb	1.0/2.2	1.5/3.3	2.6/5.7	3.5/7.7	4.7/10.4	5.9/13.0
	kg/lb	1.3/2.9	1.8/4.0	3.0/6.6	4.0/8.8	5.2/11.5	6.7/14.8
Brake Motor Weight: Net	kg/lb	1.3/2.9	2.0/4.4	3.4/7.5	4.3/9.5	5.1/11.2	6.9/15.2
	kg/lb	1.5/3.3	2.2/4.9	3.9/8.6	4.8/10.6	5.5/12.1	7.7/17.0
Damping	Nm/krpm	0.023	0.034	0.13	0.19	0.20	0.19
	oz-in/krpm	0.2	0.3	1.1	1.7	1.8	1.7
Friction Torque	Nm	0.12	0.23	0.26	0.34	0.45	0.73
	oz-in	1.0	2.0	2.3	3.0	4.0	6.5
Max. Operating Speed	rpm	6000	6000	6000	6000	6000	5000
Shaft Material		416 Stainless Steel					
WINDING DATA (1)							
Poles		4	4	4	4	4	4
Sine Wave K _T	Nm/A	0.09	0.22	0.17	0.33	0.40	0.28
Torque Constant (2)	in-lb/A	0.8	2.0	1.5	3.0	3.6	2.5
Square Wave K _T	Nm/A	0.09	0.24	0.18	0.37	0.45	0.3
Torque Constant (3)	lb-in/A	0.88	2.2	1.6	3.3	4.0	2.7
K _E Voltage Constant (4)	V/krpm	11	27	21	41	49	34
Winding Resistance Phase to Phase at 25°C	Ohms	3.92	5.89	2.24	2.68	2.79	0.77
Winding Inductance Phase to Phase	mH	4.2	8.8	6.1	8.6	11.0	2.9
Thermal Resistance	°C/Watt	3.0	2.2	1.6	1.2	1.1	0.83
Dielectric Rating		Power Leads (R, S, T) to Ground: 1800 VACrms 50/60 Hz for 1 minute.					

MOTOR		N-5630-2	N-5637-2	N-5647-2
MECHANICAL DATA (1)				
Rotor Moment of Inertia	kg-m ²	0.0009	0.0012	0.0015
	lb-in-s ²	0.008	0.01	0.013
Rotor Moment of Inertia Motors W/Brake	kg-m ²	0.000651	0.000778	0.000893
	lb-in-s ²	0.00576	0.00689	0.00791
Motor Weight: Net	kg/lb	9.1/20.1	11/24.3	13/28.7
	kg/lb	9.6/21.2	11.7/25.8	13.8/30.4
Brake Motor Weight: Net	kg/lb	10.9/24.0	13.2/29.1	15.9/35.1
	kg/lb	11.4/25.1	13.8/30.4	13.9/37.3
Damping	Nm/krpm	0.35	0.32	0.45
	oz-in/krpm	3.1	2.8	4.0
Friction Torque	Nm	1.3	1.6	1.7
	oz-in	11	14	15
Max. Operating Speed	rpm	4000	4000	3000
Shaft Material		416 Stainless Steel		
WINDING DATA (1)				
Poles		4	4	4
Sine Wave K _T ±10%	Nm/A	0.38	0.49	0.63
Torque Constant (2)	lb-in/A	3.4	4.4	5.6
Square Wave K _T	Nm/A	0.41	0.54	0.70
Torque Constant (3)	lb-in/A	3.7	4.8	6.2
K _E Voltage Constant (4)	V/krpm	47	60	77
Winding Resistance Phase to Phase at 25°C	Ohms ±10%	0.89	1.0	1.23
Winding Inductance Phase to Phase	mH	4.3	5.2	7.0
Thermal Resistance	°C/Watt	0.81	0.76	0.70
Dielectric Rating		Power Leads (R, S, T) to Ground: 1800 VACrms 50/60 Hz for 1 minute.		
(1) Specifications are at 25°C unless otherwise noted.		(3) Peak value of per phase square wave Amperes		
(2) Peak value of per phase sine wave Amperes		(4) Peak value of sinusoidal phase to phase Volts		

STORAGE AND OPERATING CONDITIONS

Ambient Temperature: Operating	0 to 40°C (32 - 104°F)	Relative Humidity:	5% to 95%
Storage	0 to 50°C (32 - 122°F)		non-condensing

Dimensional Data

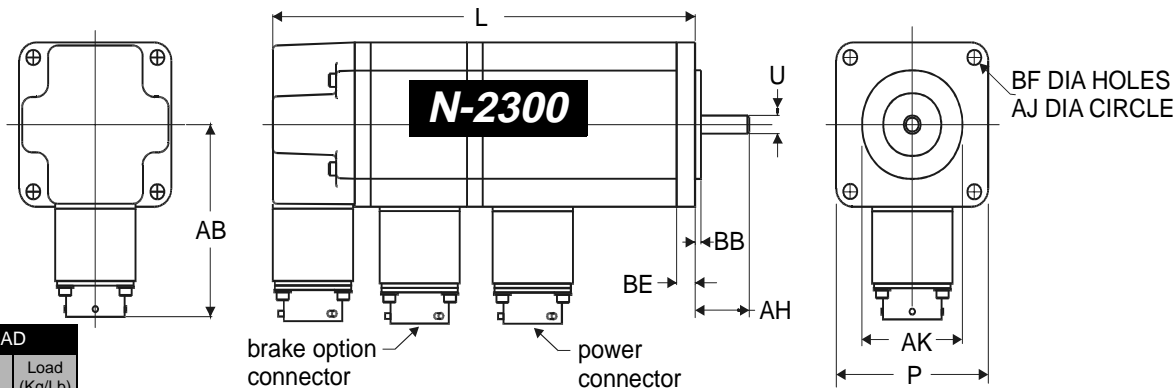

SHAFT END PLAY UNDER LOAD		
Maximum end play (All Motors)	Load	
Direction	mm/in	(Kg/Lb)
---> A	0.127/ 0.005	3.8/10
<--- B	0.025/ 0.001	

Note: End play and load are measured in inches and pounds. Metric measurements are approximate conversions from inches and pounds.

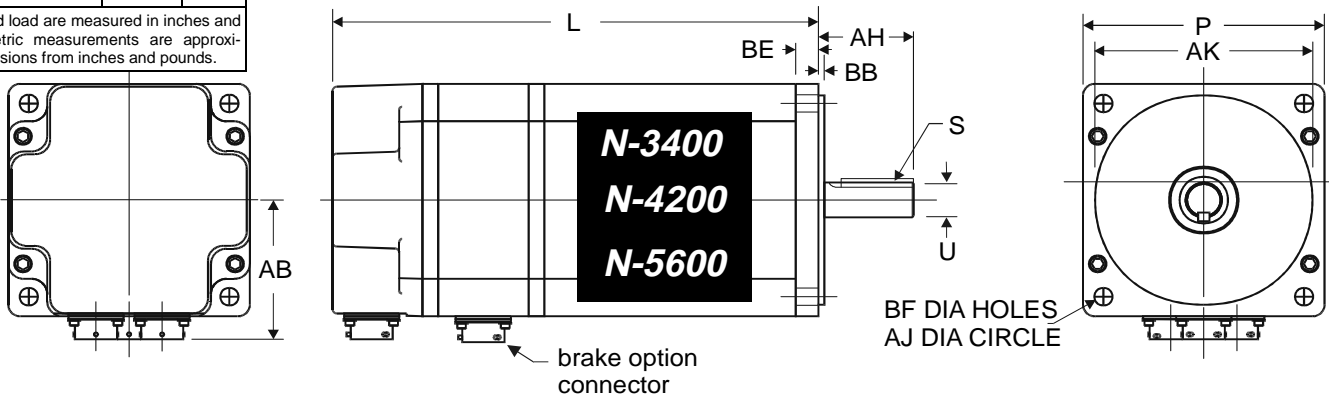

Motor Dimensions

MOTOR DIMENSIONS																				
Motor Model	AB	AH	AJ	AK	BB	BE	BF	L	L Brake	S	U	XD	TOLERANCES							
	mm/in	mm/in	mm/in	mm/in	mm/in	mm/in	mm/in	mm/in	mm/in	mm/in	mm/in	mm/in	mm	inches						
N-2302	70/2.75	21/0.81 (1)	67/2.63	38/1.50 (2)	2/0.09	7/0.28	5/0.21	118/4.63	161/6.32	NA	6/25 (3)	NA	1	-0.03	-0.00012					
N-2304													156/6.13	199/7.82	2	-0.01	-0.0004			
N-3406	63/2.48	30/1.19 (1)	98/3.88	73/2.88 (4)	3/12	8/0.32	6/0.22	144/5.67	193/7.59	3.2 X 3.2 /0.125 X 0.125 (5)	13/5 (3)	19/0.75 (6)	3	±0.5	±0.0196					
N-3412														169/6.67	218/8.59	4	±0.2	±0.0079		
N-4214	62/2.45	35/1.38 (1)	126/4.95	56/2.19 (7)				10/0.39	7/0.28				174/6.85	219/8.63	4.8 X 4.8 /0.1875 X 0.1875 (5)	16/63 (3)	24/0.94 (6)	5	-0.035	-0.0014
N-4220																			199/7.85	245/9.63
N-5630	75/2.96	50/1.97 (1)	149/5.88	114/4.50 (8)	12/0.47	0.375 in UNC	199/7.83	256/10.06			19/75 (3)	38/1.50 (6)	7	-0.016	-0.006					
N-5637														224/8.83	281/11.06	8	-0.046	-0.0181		
N-5647														250/9.83	306/12.06					

NOTE: Motors are manufactured to inch dimensions. Millimeter dimensions are approximate conversions from inches.

SUPPLEMENTAL MOTOR DIMENSIONS									
Length, from motor faceplate to center of connectors									
Connector	N-2302	N-2304	N-3406	N-3412	N-4214	N-4220	N-5630	N-5637	N-5647
Brake (mm/in)	105/4.13	143/5.63	118/4.66	144/5.66	145/5.7	170/6.7	176/6.94	202/7.94	227/8.94
Power (mm/in)	62/2.43	100/3.93	173/6.81	198/7.81	198/7.79	223/8.79	235/9.25	260/10.25	286/11.25
Encoder (mm/in)	145/5.71	183/7.22	173/6.81	198/7.81	198/7.79	223/8.79	235/9.25	260/10.25	286/11.25

Connector Data

NEMA 23-Series Encoder	
Pin	Signal
A	A+
B	A-
C	B+
D	B-
E	I+
F	I-
G	GROUND
H	Open
J	5 VDC
K	5 VDC
L	COMMON
M	COMMON
N	Open
P	Open
R	THERMOSTAT+
S	THERMOSTAT-
T	HALL A
U	HALL B
V	HALL C

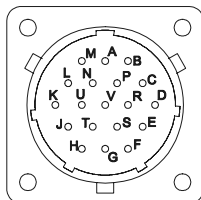

ITT Cannon Connectors	
Power Connector P/Ns	
N-2300	KPSE02E14-5P-A71
N-3400	
N-4200	
N-5600	
Connectors require 1/4 turn to seal.	
Encoder Connector P/Ns	
N-2300	KPSE02E14-19P-A71
N-3400	
N-4200	
N-5600	
Connectors require 1/4 turn to seal.	
Brake Connector P/Ns	
N-2300	KPSE02E12-3P-A71
N-3400	
N-4200	
N-5600	
Connectors require 1/4 turn to seal.	

NEMA 34, 42 & 56-Series Encoder	
Pin	Signal
A	A+
B	A-
C	B+
D	B-
E	I+
F	I-
G	GROUND
H	ABS
J	5 VDC
K	5 VDC
L	COMMON
M	COMMON
N	Open
P	Open
R	THERMOSTAT+
S	THERMOSTAT-
T	HALL A
U	HALL B
V	HALL C

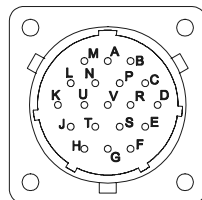

NEMA 23-Series Power Connector	
Pin	Signal
A	PHASE R
B	PHASE S
C	PHASE T
D	GROUND
E	Open

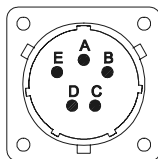

Brake Option Connector	
Pin	Signal
A	BR+
B	BR-
C	OPEN

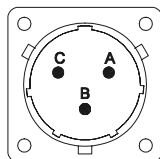

NEMA 34, 42 & 56-Series Power Connector	
Pin	Signal
A	PHASE R
B	PHASE S
C	PHASE T
D	GROUND
E	Open

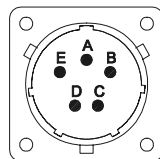

Encoder Data

Encoders are factory aligned and must not be adjusted outside the factory.

ENCODER SPECIFICATIONS		
	N-2300	N-3400, N-4200 and N-5600
Line Count	1000 (1) (2)	2000 (1)
Supply Voltage	5 VDC	5 VDC
Supply Current	175 mA max.	300 mA max.
Line Driver	LM339	26LS31
Line Driver Output	TTL	A, B, I signals: Logic 1 = 2.5 VDC min @ 20 mA DC source, Logic 0 = 0.5 VDC max @ 20 mA DC sink. HALL signals: Logic 1 = 3.5 VDC min @ 1mA DC source, Logic 0 = 0.5 VDC max @ 5mA DC sink.
Index Pulse	Refer to diagrams below (No key for physical reference)	When facing the motor, the key is oriented $90^\circ \pm 10^\circ$ clockwise (mechanical) from connectors
(1) Standard line count before quadrature.		
(2) N-2300 encoder does not have Absolute Signal (ABS)		

Encoder Outputs

N-2300 Encoder Output

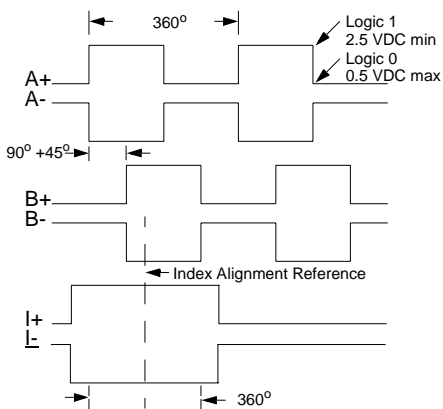

N-3400, 4200 and 5600 Encoder Output

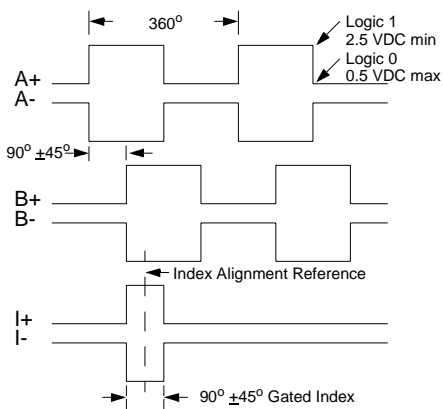

Encoder Phase-to-Neutral and Phase-to-Phase Waveforms

PHASE - NEUTRAL BACK EMF

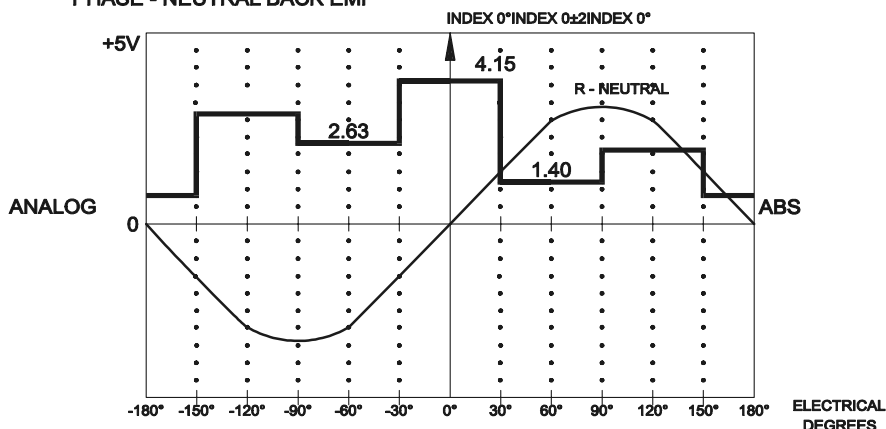

NOTE: N-3400, N-4200 and N-5600 only

PHASE - PHASE BACK EMF

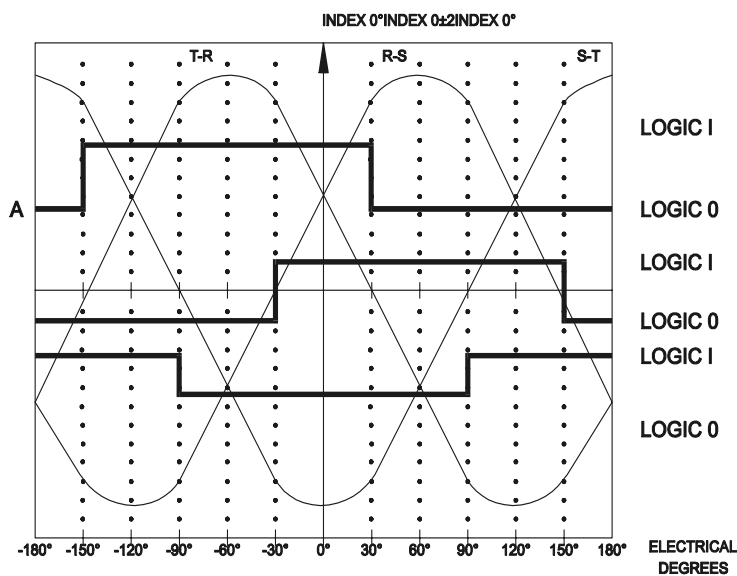

NOTE: Hall and ABS signals are in electrical degrees.

For 4 pole commutation,
360° mechanical = 720° electrical.

Options: Connectors and Shaft Seals

An environmentally sealed package may be formed when an N-Series motor is coupled with sealed cable assemblies and shaft seals.

Factory manufactured power cables and encoder cables are available in standard cable lengths of 10, 25, 50, 75 and 100 feet (3, 7.6, 15, 23 and 30 meters). Factory cables provide environmental sealing and shield termination.

Shaft Seal Kits

MOTOR SEAL KITS

MOTOR SERIES	PART NUMBER	SIZE
		(Outside Dia x Inside Dia x Width) mm/in
N-2300	0041-5068	0.035 x 0.001 x 0.005 / 0.875 x 0.250 x 0.125
N-3400	0041-5069	0.044 x 0.019 x 0.010 / 1.125 x 0.500 x 0.250
N-4200	0041-5070	0.044 x 0.025 x 0.010 / 1.125 x 0.625 x 0.250
N-5600	0041-5071	0.054 x 0.030 x 0.010 / 1.375 x 0.750 x 0.250

NOTE: Shaft seals are manufactured to inch dimensions. Millimeter dimensions are conversions from inches.
Shaft seals require a lubricant to reduce wear. Lubricant is provided with kit.

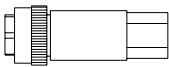

Connectors and Connector Kits

MOTOR POWER CONNECTORS

	PART NUMBER	CONNECTOR TYPE
	9101-1557	POWER - SOLDER
	9101-1558	ENCODER - SOLDER
	9101-1698	BRAKE - SOLDER

These connectors provide environmental sealing and shield termination.

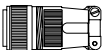
OTHER MATING CONNECTORS

	STRAIGHT	CONNECTOR TYPE	RIGHT ANGLE		
	MS3126F14-19S	ENCODER - CRIMP	KPSE08F14-19S	PT08SE14-19S	
	MS3116F14-19S	ENCODER - SOLDER	KPT08F14-19S	PT08E14-19S	
	MS3126F14-5S	POWER - CRIMP	KPSE08F14-5S	PT08SE14-5S	
	MS3116F14-5S	POWER - SOLDER	KPT08F14-5S	PT08E14-5S	
	MS3126F12-3S	BRAKE - CRIMP	KPSE08F12-3S	PT08SE12-3S	
MS3116F12-3S	BRAKE - SOLDER	KPT08F12-3S	PT08E12-3S		

NOTES:

- These connectors provide environmental sealing, but do not provide cable shield termination.
- Angle Connectors are ITT Cannon (KP) and Amphenol (PT).
- Power contacts are size 16 AWG. Crimp type connectors accept wire sizes 20 AWG to 16 AWG.
- Brake and Encoder contacts are size 20 AWG. Crimp type connectors accept wire sizes 24 AWG to 20 AWG.

Motor Radial Load Force Ratings

Motors are capable of carrying an axial load in most applications. The following table provides guidelines for 20,000 hour bearing life with a specified radial load applied to the center of the shaft. Please consult with Reliance Motion Control regarding loads, operating speeds and bearing life in your particular application to ensure the proper selection of motors.

STANDARD RADIAL LOAD FORCE RATINGS							
MOTOR	500 rpm lb (kg)	1000 rpm lb (kg)	2000 rpm lb (kg)	3000 rpm lb (kg)	4000 rpm lb (kg)	5000 rpm lb (kg)	6000 rpm lb (kg)
N-2302	17 (8)	16 (7)	14 (6)	12 (5)	11 (5)	9 (4)	8 (4)
N-2304	19(9)	17 (8)	15 (7)	14 (6)	12 (5)	10 (5)	8 (4)
N-3406	103 (47)	82 (37)	65 (29)	56 (25)	51 (23)	48 (22)	45 (20)
N-3412	113 (51)	89 (40)	71 (32)	62 (28)	56 (25)	53 (24)	49 (22)
N-4214	137 (62)	109 (49)	86 (39)	76 (34)	68 (31)	64 (29)	
N-4220	146 (66)	116 (53)	92 (42)	80 (36)	73 (33)	68 (31)	
N-5630	188 (85)	149 (68)	118 (54)	103 (47)	94 (43)		
N-5637	197 (89)	156 (71)	124 (56)	108 (49)	98 (44)		
N-5647	203 (92)	161 (73)	128 (58)	112 (51)			

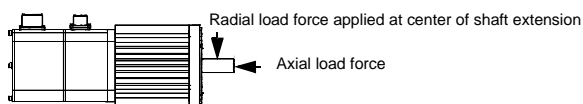

NOTE: When motor shaft has no radial load, axial load rating = 100% of radial load rating above.

When motor shaft has both a radial load and an axial load, axial load rating = 44% of radial load rating above.

Brake Motor Application Guidelines

The brakes offered as options on these servo motors are holding brakes. They are designed to hold the motor shaft at 0 rpm for up to the rated brake holding torque. The brakes are spring-set type, and release when voltage is applied to the brake coil.

The brakes are *not* designed for stopping rotation of the motor shaft. Servo drive inputs should be used to stop motor shaft rotation. The recommended method of stopping motor shaft rotation is to command the servo drive to decelerate the motor to 0 rpm, and engage the brake after the servo drive has decelerated the motor to 0 rpm.

If system main power fails, the brakes can withstand use as stopping brakes. However, use of the brakes as stopping brakes creates rotational mechanical backlash that is potentially damaging to the system, increases brake pad wear and reduces brake life. The brakes are *not* designed nor are they intended to be used as a safety device.

A separate power source is required to disengage the brake. This power source may be controlled by the servo motor controls, in addition to manual operator controls.

Brake Specifications

BRAKE DATA				
MOTOR SERIES	MAX. BACKLASH (BRAKE ENGAGED)	HOLDING TORQUE		COIL CURRENT at 24 VDC
N-2300	1 degree	5	0.56	0.28 ADC
N-3400		15	1.69	0.36 ADC
N-4200		30	3.39	0.36 ADC
N-5600		50	5.64	0.71 ADC

Motor Installation

Observe the following installation guidelines and those in the Product Notice:



WARNING: Motors and linkages must be securely mounted for a system to be operational. Disassembled equipment should be appropriately identified (tagged-out) and access to electrical power restricted (locked-out).

Failure to observe these safety procedures could result in personal injury and damage to equipment.

1. Do not run motors that are not properly mounted. Attach all power and data cables after the motor is mounted.
2. Mount motors with connectors pointing downward and use a drip loop in the cable to keep liquids flowing away from the connectors.
3. Consider motor case temperature if necessary to safeguard operator and maintenance staff. Maximum case temperature is approximately 100°C (212°F) for a motor used at continuous rating in a 40°C ambient temperature.
4. The installer must comply with all local regulations and should use equipment and installation practices that promote electromagnetic compatibility and safety.

Preventing Electrical Noise

ElectroMagnetic Interference (EMI), commonly called “noise”, may adversely impact motor performance by inducing stray signals. Effective techniques to counter EMI include filtering the AC power, shielding and separating signal carrying lines, and practicing good grounding techniques. Effective AC power filtering can be achieved through the use of isolated AC power transformers or properly installed AC line filters. Physically separate signal lines from motor cabling and power wiring; do *not* parallel signal wires with motor or power wires or route signal wires over the vent openings of servo drives. Ground all equipment using a single-point parallel ground system that employs ground bus bars or straps. If necessary, use electrical noise remediation techniques to mitigate EMI in “noisy” environments.

Knowledgeable cable routing and careful cable construction improves system electromagnetic compatibility (EMC). General cable build and installation guidelines include:

1. Keep wire lengths as short as physically possible.
2. Route signal cables (encoder, serial, analog) away from motor and power wiring.
3. Separate cables by 1 foot minimum for every 30 feet of parallel run.
4. Ground both ends of the encoder cable and twist the signal wire pairs.
5. Use shielded motor cables when necessary to prevent electromagnetic interference (EMI) with other equipment.

Couplings and Pulleys

Mechanical connections to the motor shaft, such as couplings and pulleys, require a rigid coupling or a reinforced timing belt. The high dynamic performance of servo motors can cause couplings, pulleys or belts to loosen or slip over time. A loose or slipping connection will cause system instability and may damage the motor shaft and keyway. All connections between the system and the servo motor shaft must be rigid to achieve acceptable response from the system. Connections should be periodically inspected to verify the rigidity.

When mounting couplings or pulleys to the motor shaft, ensure that the connections are properly aligned and that axial and radial loads are within the specifications of the motor. The section “Load Force Ratings” provides guidelines to achieve 20,000 hours of bearing life. www.DataSheet4U.com Additional information about load force ratings, including graphical depiction of varied load ratings and bearing life, is available for any motor from the Technical Support groups listed on the back cover.

Product Information

Motor Part Number Identification

N - 42 14 - 2 - H 00 AA

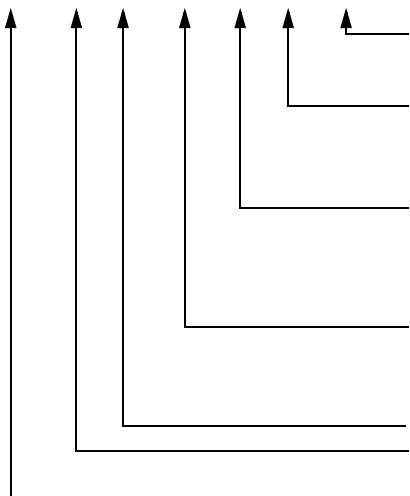

FACTORY DESIGNATED SPECIAL OPTIONS
AA = STANDARD FLANGE

OPTIONS

00 = STANDARD
04 = 24 VDC BRAKE

ENCODER LINE COUNT

F = 1000 (N-2300 STANDARD)
H = 2000 (N-3400 thru N-5600 STANDARD)
K = 5000

MOTOR WINDING VOLTAGE DESIGNATOR

1 = 115 VAC
2 = 230 VAC

CONTINUOUS TORQUE CAPABILITY (LB-IN) FRAME SIZE

SERIES DESIGNATOR

N = NEMA FRAME STYLE

NOTE: OPTIONS NOT AVAILABLE ON ALL SIZES

Disposal or Warranty Return of Motors

Motors may contain environmentally regulated materials, such as lead solder and circuit boards. When disposing of a motor, please recycle motors per regulations at your location. You may choose to return a motor for disposal by contacting your supplier.

Please contact the source that supplied the motor for warranty, non-warranty, or disposal work. All returned products require a Return Material Authorization (RMA) number for efficient processing and tracking.

Technical Support

In the United States, hours for product assistance are 7:00 AM to 5:00 PM (CST), Monday through Friday at 1-800-328-3983 or via fax at 1-612-942-3636.

In Europe, product assistance can be obtained between 8:30 and 17:30 local time, Monday through Friday at (+44)1270 580142 or via fax at (+44)1270 580141.

N-Series Motors
Brushless Servo Motors
Part Number 0013-1065-001 Rev B

Electro-Craft[®]
MOTION CONTROL

Electro-Craft Motion Control
6950 Washington Avenue South
Eden Prairie, MN 55344
612-942-3600