

DATA SHEET

GENERAL PURPOSE CHIP RESISTORS

RC0603 (Pb Free)
5%, 1%



SCOPE

This specification describes RC0603 series chip resistors with lead-free terminations made by thick film process.

ORDERING INFORMATION

Part number is identified by the series, size, tolerance, packing type, temperature coefficient, taping reel and resistance value.

PHYCOMP ORDERING CODE

I2NC CODE

2322 / 2350 **XXX XXXXX L**
 (1) (2) (3) (4)

TYPE/ 0603	START IN ⁽¹⁾	TOL. (%)	RESISTANCE RANGE	PAPER / PE TAPE ON REEL (units) ⁽²⁾		
				5,000	10,000/not preferred	20,000
RC21	2322	±5%	1 to 10 MΩ	702 60xxx	702 70xxx	702 81xxx
RC22	2322	±1%	1 to 10 MΩ	704 6xxxx	704 7xxxx	704 8xxxx
HRC21	2350	±5%	11 to 22 MΩ	522 10xxx	-	-
Jumper	2322	-	0 Ω	702 96001	702 97001	702 92002

(1) The resistors have a 12-digit ordering code starting with 2322.

(2) The subsequent 4 or 5 digits indicate the resistor tolerance and packaging.

(3) The remaining 4 or 3 digits represent the resistance value with the last digit indicating the multiplier as shown in the table of "Last digit of I2NC".

(4) "L" means lead-free terminations.

▭ Last digit of I2NC

Resistance decade ⁽³⁾	Last digit
0.01 to 0.0976 Ω	0
0.1 to 0.976 Ω	7
1 to 9.76 Ω	8
10 to 97.6 Ω	9
100 to 976 Ω	1
1 to 9.76 kΩ	2
10 to 97.6 kΩ	3
100 to 976 kΩ	4
1 to 9.76 MΩ	5
10 to 97.6 MΩ	6

Example:

0.02 Ω	=	0200 or 200
0.3 Ω	=	3007 or 307
1 Ω	=	1008 or 108
33 kΩ	=	3303 or 333
10 MΩ	=	1006 or 106

ORDERING EXAMPLE

The ordering code of a RC22 resistor, value 56 Ω with ±1% tolerance, supplied in tape of 5,000 units per reel is:
232270465609L.

CTC CODE

RC0603 **X X X XX XXXX L**
 (1) (2) (3) (4) (5) (6)

(1) TOLERANCE

F = ±1%

J = ±5%

(2) PACKAGING TYPE

R = Paper/PE taping reel

(3) TEMPERATURE COEFFICIENT OF RESISTANCE

- = Base on spec

(4) TAPING REEL

07 = 7 inch dia. Reel

10 = 10 inch dia. Reel (not preferred)

13 = 13 inch dia. Reel

(5) RESISTANCE VALUE

5R6, 56R, 560R, 5K6, 56K, 22M

(6) RESISTOR TERMINATIONS

L = Lead free terminations (pure Tin)

ORDERING EXAMPLE

The ordering code of a RC0603 chip resistor, value 56 Ω with ±1% tolerance, supplied in 7-inch tape reel is: **RC0603FR-0756RL.**

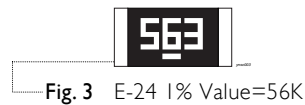
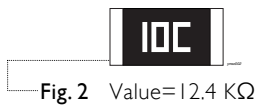
NOTE

- The "L" at the end of the code is only for ordering. On the reel label, the standard CTC or I2NC will be mentioned an additional stamp "LFP"= lead free production.
- Products with lead in terminations fulfil the same requirements as mentioned in this datasheet.
- Products with lead in terminations will be phased out in the coming months (before July 1st, 2006)

MARKING**RC0603**

E-24 series: 3 digits

First two digits for significant figure and 3rd digit for number of zeros



E-96 series: 3 digits for 0603 ±1% EIA-96 marking method

For 0603 ±1% E-24 series, one short bar under marking letter

For marking codes, please see EIA-marking code rules in data sheet "Chip resistors instruction".

CONSTRUCTION

The resistors are constructed out of a high-grade ceramic body. Internal metal electrodes are added at each end and connected by a resistive paste. The composition of the paste is adjusted to give the approximate required resistance and laser cutting of this resistive layer that achieves tolerance trims the value. The resistive layer is covered with a protective coat and printed with the resistance value. Finally, the two external terminations (pure Tin) are added. See fig. 4.

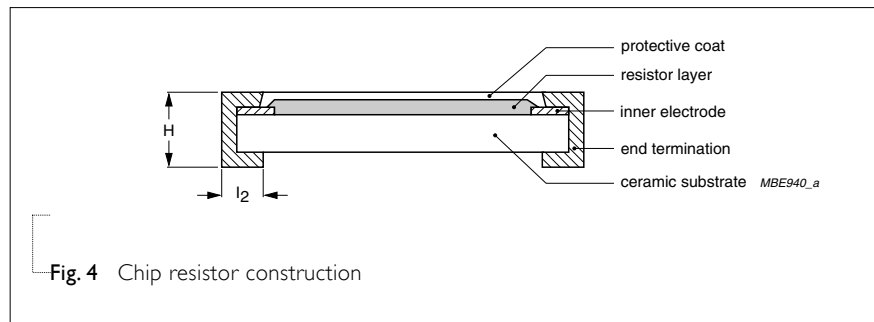
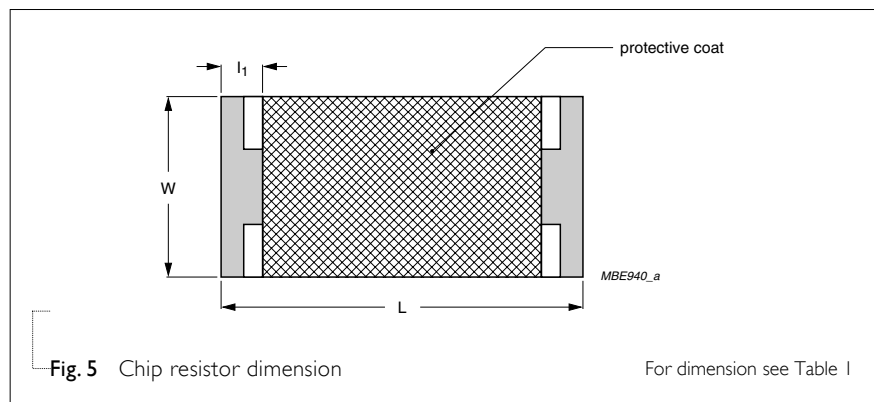
**DIMENSIONS**

Table I

TYPE	RC0603
L (mm)	1.60 ±0.1
W (mm)	0.80 ±0.10
H (mm)	0.45 ±0.10
l ₁ (mm)	0.25 ±0.15
l ₂ (mm)	0.25 ±0.15



Chip Resistor Surface Mount

RC

SERIES

0603 (Pb Free)

ELECTRICAL CHARACTERISTICS

Table 2

CHARACTERISTICS	RC0603 1/10 W
Operating Temperature Range	-55 °C to +155 °C
Maximum Working Voltage	50 V
Maximum Overload Voltage	100 V
Dielectric Withstanding Voltage	100 V
Resistance Range	5% (E24) 1 Ω to 22 MΩ
	1% (E96) 1 Ω to 10 MΩ
	Zero Ohm Jumper < 0.05 Ω
Temperature Coefficient	10 Ω < R ≤ 10 MΩ ±100 ppm/°C
	R ≤ 10 Ω; R > 10 MΩ ±200 ppm/°C
Jumper Criteria	Rated Current 1.0 A
	Maximum Current 2.0 A

FOOTPRINT AND SOLDERING PROFILES

For recommended footprint and soldering profiles, please see the special data sheet "Chip resistors mounting".

ENVIRONMENTAL DATA

For material declaration information (IMDS-data) of the products, please see the separated info "Environmental data".

PACKING STYLE AND PACKAGING QUANTITY

Table 3 Packing style and packaging quantity

PRODUCT TYPE	PACKING STYLE	REEL DIMENSION	QUANTITY PER REEL
RC0603	Paper / PE Taping Reel (R)	7" (178 mm)	5,000 units
		10" (254 mm) / not preferred	10,000 units
		13" (330 mm)	20,000 units

NOTE

1. For Paper/PE tape and reel specification/dimensions, please see the special data sheet "Packing" document.

FUNCTIONAL DESCRIPTION**POWER RATING**

RC0603 rated power at 70°C is 1/10 W

RATED VOLTAGE

The DC or AC (rms) continuous working voltage corresponding to the rated power is determined by the following formula:

$$V = \sqrt{P \times R}$$

Where

V=Continuous rated DC or
AC (rms) working voltage (V)

P=Rated power (W)

R=Resistance value (Ω)

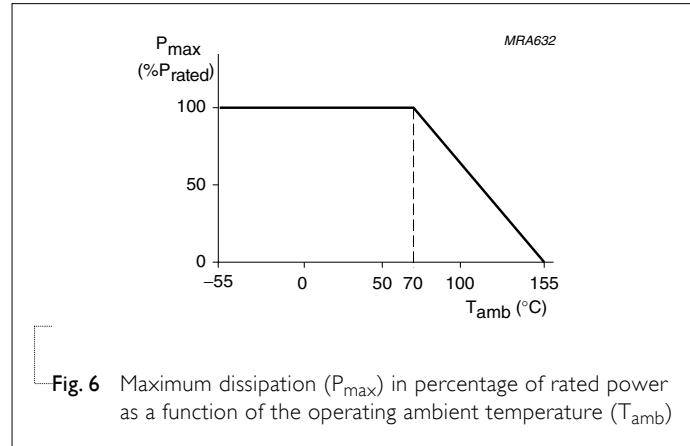
PULSE LOADING CAPABILITIES

Fig. 6 Maximum dissipation (P_{max}) in percentage of rated power as a function of the operating ambient temperature (T_{amb})

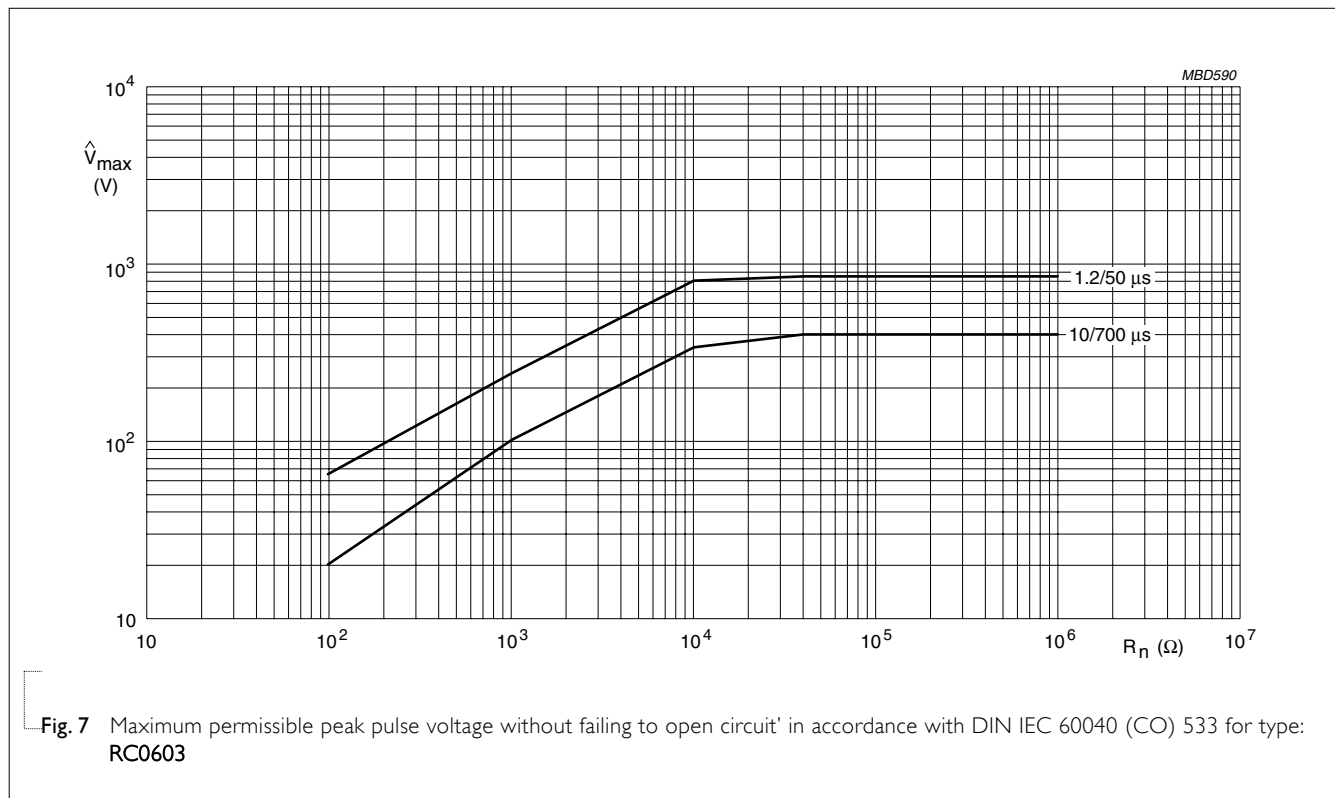


Fig. 7 Maximum permissible peak pulse voltage without failing to open circuit' in accordance with DIN IEC 60040 (CO) 533 for type: RC0603

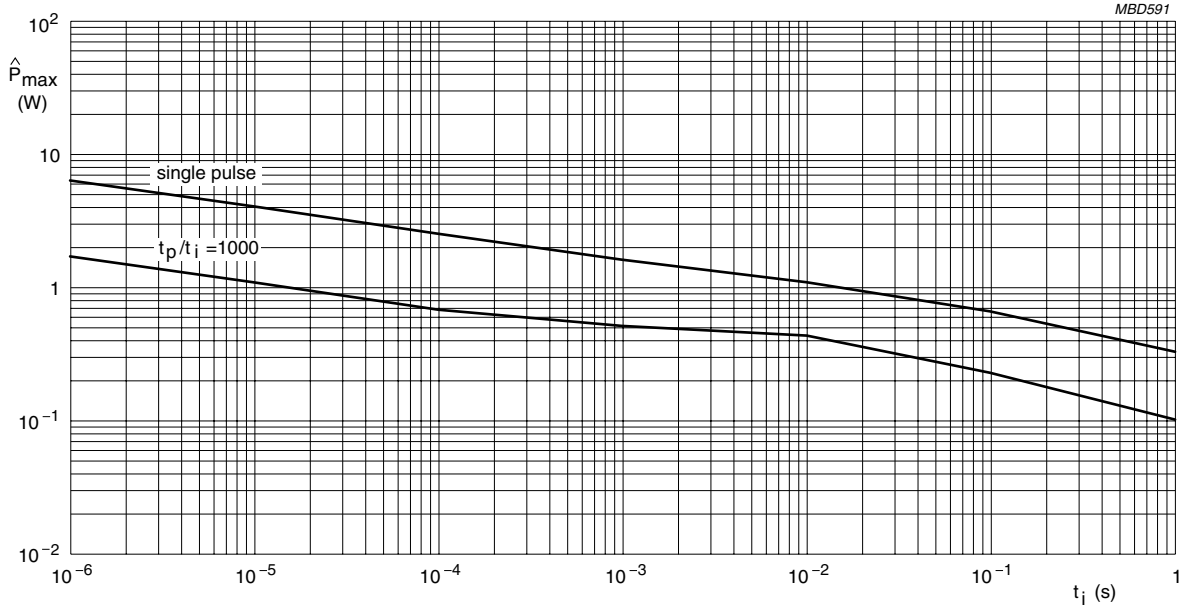


Fig. 8 Pulse on a regular basis for type: RC0603; maximum permissible peak pulse power as a function of pulse duration for single pulse and repetitive pulse $t_p/t_i = 1000$

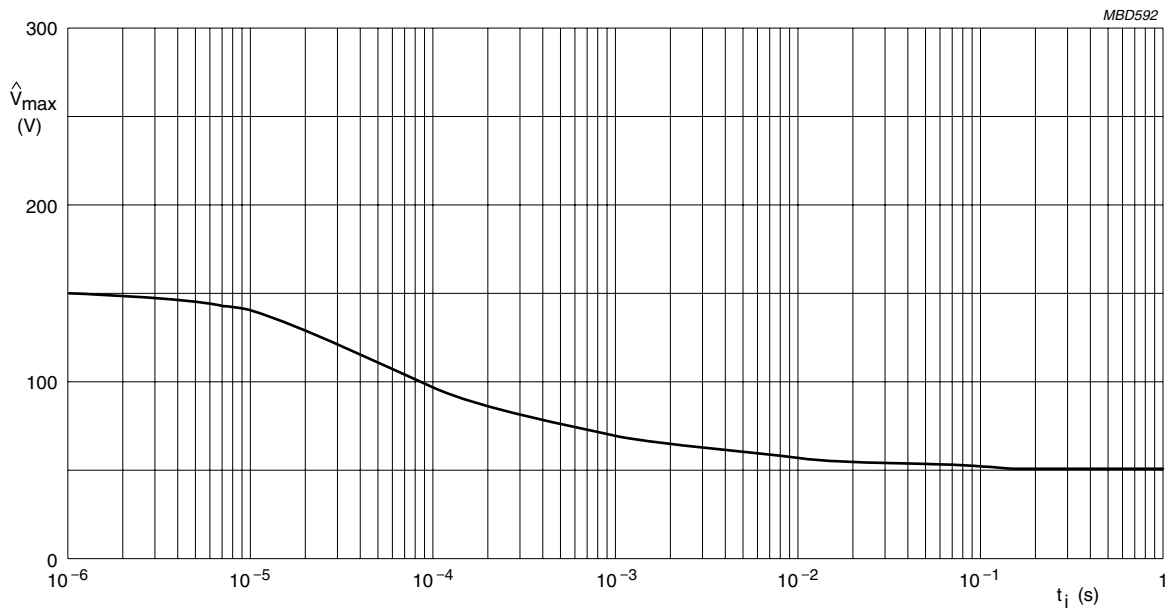


Fig. 9 Pulse on a regular basis for type: RC0603; maximum permissible peak pulse voltage as a function of pulse duration

Chip Resistor Surface Mount

RC

SERIES

0603 (Pb Free)

TESTS AND REQUIREMENTS

Table 4 Test condition, procedure and requirements

TEST	TEST METHOD	PROCEDURE	REQUIREMENTS
Temperature Coefficient of Resistance (T.C.R.)	MIL-STD-202F-method 304;	At +25/-55 °C and +25/+125 °C	Refer to table 2
	JIS C 5202-4.8	Formula: $T.C.R = \frac{R_2 - R_1}{R_1(t_2 - t_1)} \times 10^6 \text{ (ppm/°C)}$ Where $t_1 = +25 \text{ °C}$ or specified room temperature $t_2 = -55 \text{ °C}$ or +125 °C test temperature R_1 = resistance at reference temperature in ohms R_2 = resistance at test temperature in ohms	
Thermal Shock	MIL-STD-202F-method 107G; IEC 60115-1 4.19	At -65 (+0/-10) °C for 2 minutes and at +155 (+10/-0) °C for 2 minutes; 25 cycles	±(0.5%+0.05 Ω) for 1% tol. ±(1.0%+0.05 Ω) for 5% tol.
Low Temperature Operation	MIL-R-55342D-Para 4.7.4	At -65 (+0/-5) °C for 1 hour; RCWV applied for 45 (+5/-0) minutes	±(0.5%+0.05 Ω) for 1% tol. ±(1.0%+0.05 Ω) for 5% tol. No visible damage
Short Time Overload	MIL-R-55342D-Para 4.7.5; IEC 60115-1 4.13	2.5 × RCWV applied for 5 seconds at room temperature	±(1.0%+0.05 Ω) for 1% tol. ±(2.0%+0.05 Ω) for 5% tol. No visible damage
Insulation Resistance	MIL-STD-202F-method 302; IEC 60115-1 4.6.1.1	RCOV for 1 minute Type RC0603 Voltage (DC) 100 V	≥10 GΩ
Dielectric Withstand Voltage	MIL-STD-202F-method 301; IEC 60115-1 4.6.1.1	Maximum voltage (V_{rms}) applied for 1 minute Type RC0603 Voltage (AC) 100 V_{rms}	No breakdown or flashover
Resistance to Soldering Heat	MIL-STD-202F-method 210C; IEC 60115-1 4.18	Unmounted chips; 260 ±5 °C for 10 ±1 seconds	±(0.5%+0.05 Ω) for 1% tol. ±(1.0%+0.05 Ω) for 5% tol. No visible damage
Life	MIL-STD-202F-method 108A; IEC 60115-1 4.25.1	At 70±2 °C for 1,000 hours; RCWV applied for 1.5 hours on and 0.5 hour off	±(1%+0.05 Ω) for 1% tol. ±(3%+0.05 Ω) for 5% tol.

Chip Resistor Surface Mount

RC

SERIES

0603 (Pb Free)

10

TEST	TEST METHOD	PROCEDURE	REQUIREMENTS	
Solderability	MIL-STD-202F-method 208A;	Solder bath at 245±3 °C	Well tinned (≥95% covered)	
	IEC 60115-1 4.17	Dipping time: 2±0.5 seconds	No visible damage	
Bending Strength	JIS C 5202.6.14;	Resistors mounted on a 90 mm glass epoxy resin PCB (FR4) Bending: 5 mm	±(1.0%+0.05 Ω) for 1% tol.	
	IEC 60115-1 4.15		±(1.0%+0.05 Ω) for 5% tol. No visible damage	
Resistance to Solvent	MIL-STD-202F-method 215; IEC 60115-1 4.29	Isopropylalcohol (C ₃ H ₇ OH) or dichloromethane (CH ₂ Cl ₂) followed by brushing	No smeared	
Noise	JIS C 5202 5.9; IEC 60115-1 4.12	Maximum voltage (V _{rms}) applied.	Resistors range	Value
			R < 100 Ω	10 dB
			100 Ω ≤ R < 1 KΩ	20 dB
			1 KΩ ≤ R < 10 KΩ	30 dB
			10 KΩ ≤ R < 100 KΩ	40 dB
			100 KΩ ≤ R < 1 MΩ	46 dB
			1 MΩ ≤ R ≤ 22 MΩ	48 dB
Humidity (steady state)	JIS C 5202 7.5; IEC 60115-8 4.24.8	1,000 hours; 40±2 °C; 93(+2/-3)% RH RCWV applied for 1.5 hours on and 0.5 hour off	±(0.5%+0.05 Ω) for 1% tol. ±(2.0%+0.05 Ω) for 5% tol.	
Leaching	EIA/IS 4.13B; IEC 60115-8 4.18	Solder bath at 260±5 °C Dipping time: 30±1 seconds	No visible damage	
Intermittent Overload	JIS C 5202 5.8	At room temperature; 2.5 × RCWV applied for 1 second on and 25 seconds off; total 10,000 cycles	±(1.0%+0.05 Ω) for 1% tol. ±(2.0%+0.05 Ω) for 5% tol.	
Resistance to Vibration	On request	On request		
Moisture Resistance Heat	MIL-STD-202F-method 106F; IEC 60115-1 4.24.2	42 cycles; total 1,000 hours Shown as figure 10	±(0.5%+0.05Ω) for 1% tol. ±(2.0%+0.05Ω) for 5% tol. No visible damage	

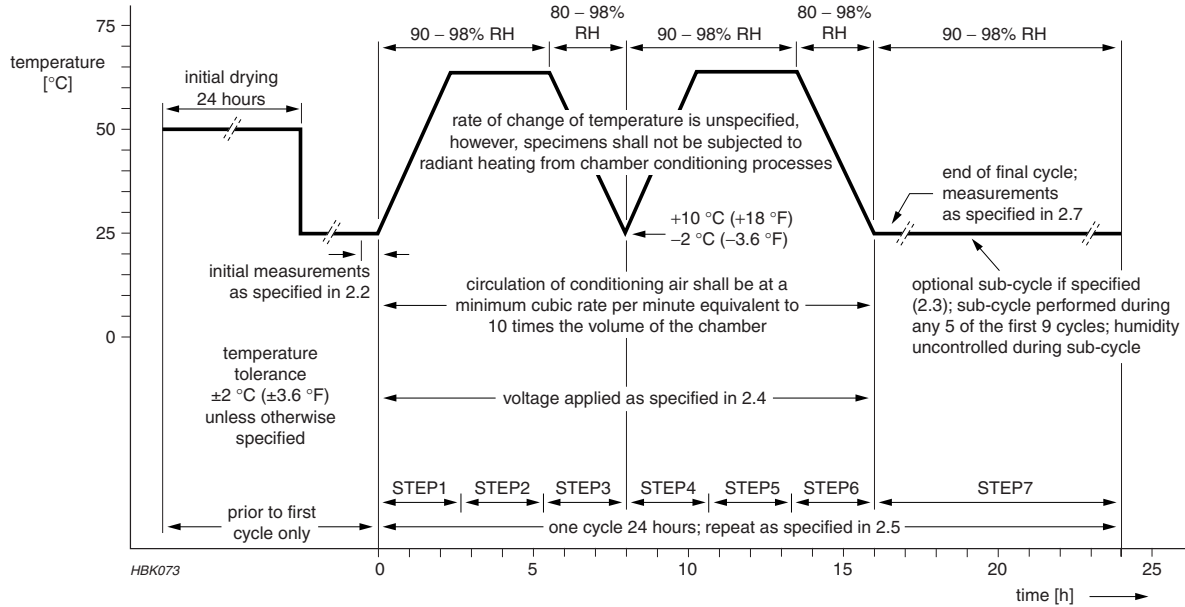


Fig. 10 Moisture resistance test requirements

REVISION HISTORY

REVISION	DATE	CHANGE NOTIFICATION	DESCRIPTION
Version 1	Aug 02, 2004	-	<ul style="list-style-type: none"> - New datasheet for 0603 thick film 1% and 5% with lead-free terminations - Replace the 0603 part of pdf files: RC01_11_21_31_5, RC02_12_22_32_10, and HRC21_5_4 - Test method and procedure updated - PE tape added (paper tape will be replaced by PE tape) - High ohmic products combined into standard products.
Version 2	Aug 19, 2004	-	-