



DS31256DK

256-Channel, High-Throughput HDLC Controller Demonstration Kit

www.maxim-ic.com

GENERAL DESCRIPTION

The DS31256DK is a demonstration and evaluation kit for the DS31256 Envoy 256-channel, high-throughput HDLC controller. The DS31256DK board is a PCI-based platform that offers quick and easy evaluation of the DS31256 HDLC controller, low-cost prototyping, and rapid software development. The DS31256DK operates with a software suite that runs under Microsoft Windows[®]95/98/NT. The PC platform must be at least a 200MHz+ Pentium II class CPU with 32MB of RAM.

Windows is a registered trademark of Microsoft Corp.

ORDERING INFORMATION

PART	DESCRIPTION
DS31256	Demonstration Kit

FEATURES

- Headers Provide Access to Clock, Sync, and Data for 16 Physical Ports
- Full Source Code
- Windows/Windows NT GUI for Device Configuration and Evaluation
- Programmable PLD for Port Connectivity and Clock Generation
- Local Bus Header for Control and Configuration of External Devices
- Hardware Prototyping Area

DEMO KIT CONTENTS

CD-ROM Includes:

- HDLC Application Notes
- DS31256DK Data Sheet/Manual
- Installation Guide
- DS31256 Data Sheet
- Executable Evaluation Application
- Source Code for Driver and GUI Application

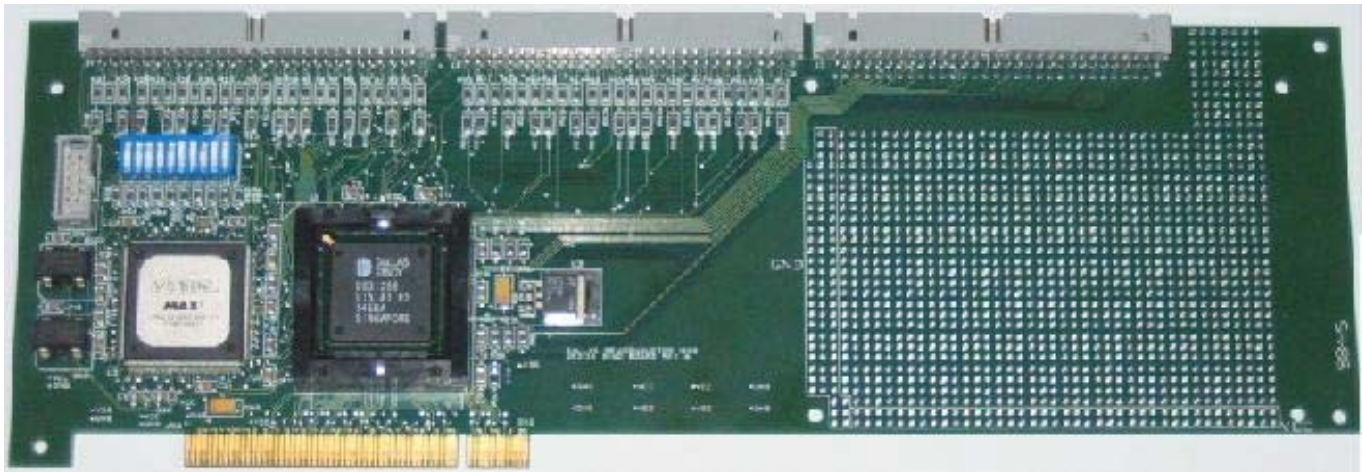

TABLE OF CONTENTS

1.	GENERAL OVERVIEW	3
2.	SOFTWARE	10
2.1	ARCHITECTURE	10
2.2	INTRODUCTION TO CHAT	10
2.3	CHAT GUI	11
2.3.1	<i>Main GUI Interface—Configuration</i>	11
2.3.2	<i>Show Results</i>	17
2.3.3	<i>Memory Viewer</i>	19
2.3.4	<i>DMA Configuration</i>	20
2.3.5	<i>Register Access</i>	21
2.4	DRIVER	22
3.	INSTALLATION AND GETTING STARTED	23
3.1	CARD INSTALLATION	23
3.1.1	<i>Windows 95 Systems</i>	23
3.1.2	<i>Windows 98 Systems</i>	23
3.1.3	<i>Windows NT Systems</i>	24
3.2	SOFTWARE INSTALLATION	24
3.3	OPERATIONAL TEST	24
4.	APPENDIX A	25

LIST OF FIGURES

Figure 1-1. PCI Card Configuration.....	5
Figure 1-2. Port PLD Schematic	6
Figure 2-1. Software Architecture	10
Figure 2-2. Software Main GUI	11
Figure 2-3. Show Results GUI	17
Figure 2-4. Memory Viewer GUI	19
Figure 2-5. DMA Configuration GUI.....	20
Figure 2-6. Registers Access GUI	21
Figure 2-7. Low-Level API Source Block Relationships	22

LIST OF TABLES

Table 1-A. Header A Definition	7
Table 1-B. Header B Definition	8
Table 1-C. Header C Definition.....	9
Table 2-A. Low-Level API Source Block Contents	22

1. GENERAL OVERVIEW

The DS31256DK is a demonstration and evaluation kit for the DS31256 Envoy 256-channel, high-throughput HDLC controller. The DS31256DK is intended to be used in a full-size PC platform, complete with PCI. The DS31256DK operates with a software suite that runs under Microsoft Windows 95/98/NT. The PC platform must be at least a 200MHz+ Pentium II class CPU with 32MB of RAM. [Figure 1-1](#) details an outline of the PCI board for the DS31256DK.

The DS31256DK was designed to be as simple as possible but offers the flexibility to be used in a number of different configurations. The DS31256DK has all the DS31256's port and local bus pins, which are easily accessible through headers on top of the card. A second DS31256DK can also be loaded into the PC in an adjacent PCI slot to add additional functions such as:

- Multiple T1/E1 framers
- T3 line interface
- HSSI interface
- V.35 interfaces

An Altera 9000 series PLD device is connected to all port pins on the DS31256. The PLD can be loaded with various configurations through a programming port (J4) that resides on the DS31256DK. This PLD generates clocks and frame syncs as well as routes data from one port to another in a daisy-chain fashion to allow testing the device under worst-case loading ([Figure 1-2](#)). Two oscillators provide the port timing.

The transmit side of a port is derived from one clock and the receive side from another, so that they can be asynchronous to one another. If the PLD is not needed, it can be tri-stated to remove it (electrically) from the board. Signals can then be sent to the DS31256 by the pin headers.

The board is intended to be a full-size PCI card that can only be plugged into a 5V PCI system environment. There is a 256-pin plastic BGA socket on the board for the DS31256.

Only the DS31256 operates at 3.3V. Since it cannot be guaranteed that a 3.3V supply exists in a 5V PCI system environment, the DS31256DK has a linear regulator on it (U4: LT1086) to convert from 5V to 3.3V. All of the other logic, including the PLD and oscillators, operate at 5V. If 3.3V exists on the PCI bus, the linear regulator can be removed and a 0 Ω jumper can be installed at R97 ([Figure 1-1](#)).

The JTAG pins on the DS31256 are not active on the DS31256DK. Therefore, the JTCLK, JTDI, and JTMS signals are wired to 3.3V and $\overline{\text{JTRST}}$ is wired low.

Figure 1-1. PCI Card Configuration

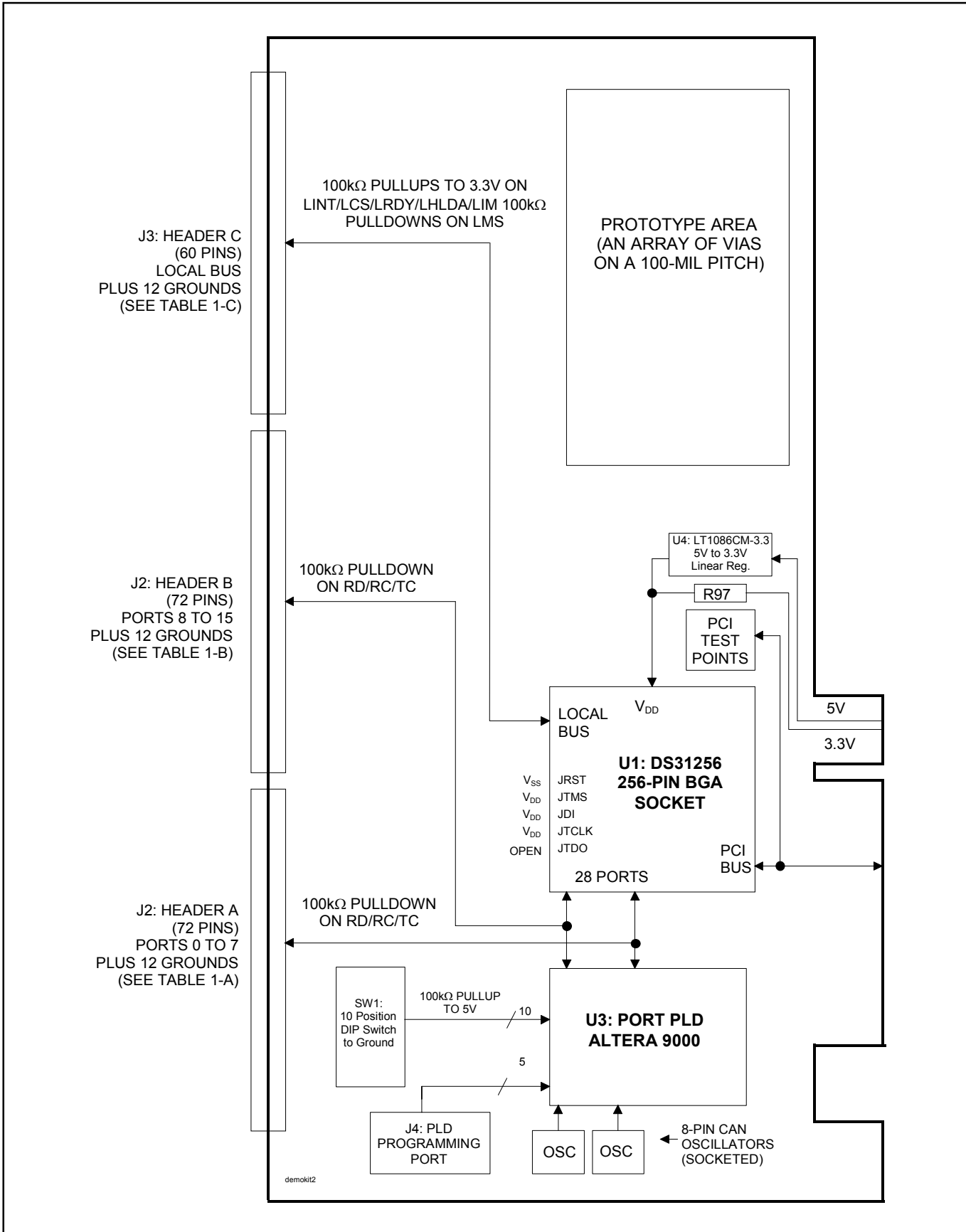
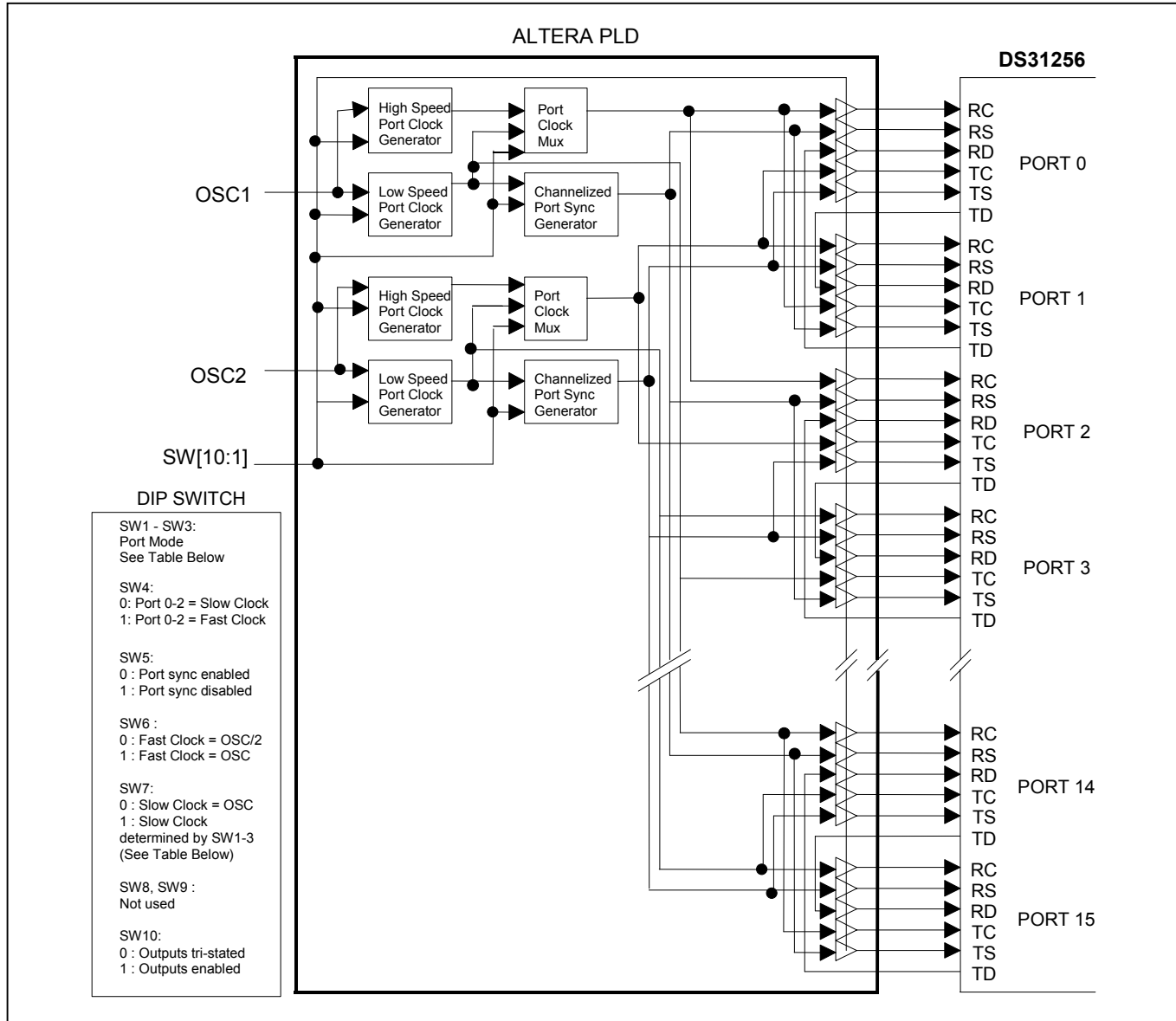

Figure 1-2. Port PLD Schematic



Clock/Sync Definitions

SW7	SW3	SW2	SW1	MODE	SLOW PORT CLOCK
0	0	0	0	Unchannelized (sync = low)	OSC
0	0	0	1	4 T1/E1 (sync active)	OSC
0	0	1	0	2 T1/E1 (sync active)	OSC
0	0	1	1	E1 (sync active)	OSC
0	1	0	0	T1 (sync active)	OSC
1	0	0	0	Unchannelized (sync = low)	66MHz / 6 = 11MHz
1	0	0	1	4 T1/E1 (sync active)	66MHz / 8 = 8.25MHz
1	0	1	0	2 T1/E1 (sync active)	66MHz / 16 = 4.125MHz
1	0	1	1	E1 (sync active)	66MHz / 32 = 2.0625MHz
1	1	0	0	T1 (sync active)	66MHz / 42 = 1.572MHz
X	1	0	1	Clock off (sync = low)	Clock driven low
X	1	1	X	Clock off (sync = low)	Clock driven low

Note 1: Switch Open = Off = High (1).

Note 2: Switch Closed = On = Low (0).

Note 3: OSC1 and OSC2 are recommended to be the same frequency.

Note 4: The frequency of OSC1 and OSC2 supplied with the DK board is 66MHz.

Table 1-A. Header A Definition

1	RS0	2	TS0
3	RD0	4	TD0
5	RC0	6	TC0
7	GND	8	GND
9	RS1	10	TS1
11	RD1	12	TD1
13	RC1	14	TC1
15	GND	16	GND
17	RS2	18	TS2
19	RD2	20	TD2
21	RC2	22	TC2
23	GND	24	GND
25	RS3	26	TS3
27	RD3	28	TD3
29	RC3	30	TC3
31	RS4	32	TS4
33	RD4	34	TD4
35	RC4	36	TC4
37	GND	38	GND
39	RS5	40	TS5
41	RD5	42	TD5
43	RC5	44	TC5
45	GND	46	GND
47	RS6	48	TS6
49	RD6	50	TD6
51	RC6	52	TC6
53	GND	54	GND
55	RS7	56	TS7
57	RD7	58	TD7
59	RC7	60	TC7

Table 1-B. Header B Definition

1	RS8	2	TS8
3	RD8	4	TD8
5	RC8	6	TC8
7	GND	8	GND
9	RS9	10	TS9
11	RD9	12	TD9
13	RC9	14	TC9
15	GND	16	GND
17	RS10	18	TS10
19	RD10	20	TD10
21	RC10	22	TC10
23	GND	24	GND
25	RS11	26	TS11
27	RD11	28	TD11
29	RC11	30	TC11
31	RS12	32	TS12
33	RD12	34	TD12
35	RC12	36	TC12
37	GND	38	GND
39	RS13	40	TS13
41	RD13	42	TD13
43	RC13	44	TC13
45	GND	46	GND
47	RS14	48	TS14
49	RD14	50	TD14
51	RC14	52	TC14
53	GND	54	GND
55	RS15	56	TS15
57	RD15	58	TD15
59	RC15	60	TC15

Table 1-C. Header C Definition

1	LD0	2	LD1
3	LD2	4	LD3
5	LD4	6	LD5
7	GND	8	GND
9	LD6	10	LD7
11	LD8	12	LD9
13	LD10	14	LD11
15	GND	16	GND
17	LD12	18	LD13
19	LD14	20	LD15
21	LIM	22	LMS
23	GND	24	GND
25	LHOLD	26	LHLDA
27	LBGACK	28	$\overline{\text{LINT}}$
29	$\overline{\text{LCS}}$	30	$\overline{\text{LRDY}}$
31	LCLK	32	LBHE
33	$\overline{\text{LWR}}$	34	$\overline{\text{LRD}}$
35	LA0	36	LA1
37	GND	38	GND
39	LA2	40	LA3
41	LA4	42	LA5
43	LA6	44	LA7
45	GND	46	GND
47	LA8	48	LA9
49	LA10	50	LA11
51	LA12	52	LA13
53	GND	54	GND
55	LA14	56	LA15
57	LA16	58	LA17
59	LA18	60	LA19

2. SOFTWARE

2.1 Architecture

The DS31256DK software consists of a high-level piece of reference software called “Chat” that sits on top of a driver. This driver itself is composed of two discrete layers. The upper layer of the driver consists of various blocks of C code that are specific to the DS31256. These blocks contain an assortment of portable functions designed to serve as a low-level API for the Envoy. At the bottom level of the driver is the commercially available WinDriver, which interfaces with the Windows operating system to the DS31256DK’s PCI hardware.

Figure 2-1. Software Architecture

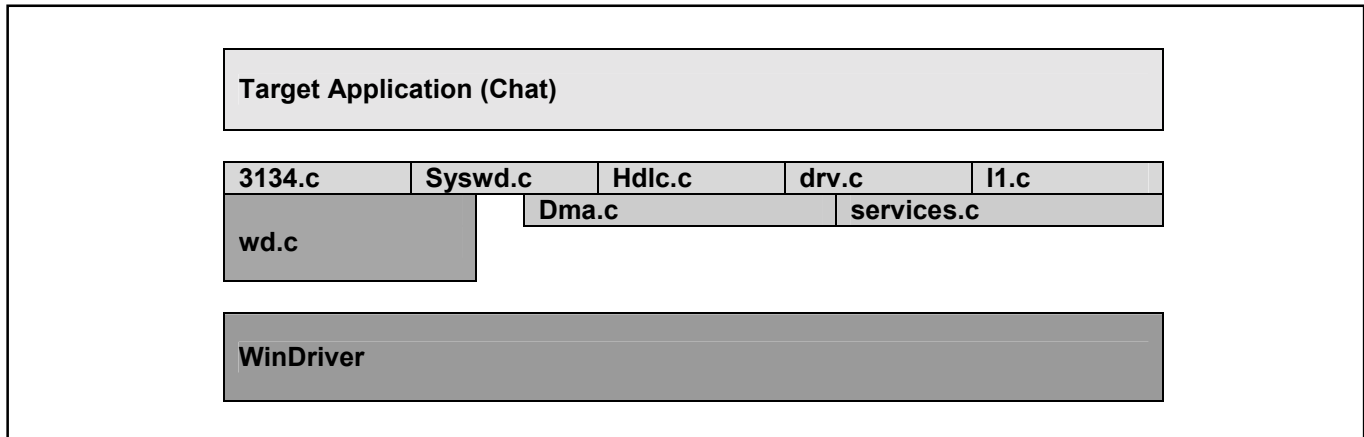

2.2 Introduction to Chat

The DS31256DK software (Chat program) runs under a PC loaded with a Windows 95/98/NT operating system using the DS31256DK PCI card. The software includes two parts—the GUI interface ([Figure 2-2](#)) and the driver code. It is developed by Visual C++ and using WinDriver to create the driver.

The software provides:

- a simple demonstration of the DS31256 with the ability to set the device into a number of different configurations
- software drivers for the DS31256
- the ability to explore and load new data into the Envoy registers
- a utility to dump the internal Envoy registers to a file and to load Envoy from a file
- user-configurable DMA parameters

The software does not implement all the functions available in the DS31256. The user controls the software through a main GUI interface, as shown in [Figure 2-2](#). The software implements 16 ports, coupled with 16 independent bidirectional HDLC channels. However, if a field in the main GUI is shaded gray, the function is not available.

HDLC Channel Assignment Table

PORT NUMBER	HDLC CHANNEL NUMBER
0	1
1	2
:	:
15	16

When a test is run, the Envoy transmits data that is looped back to either the same port (if local loopback is used) or to an adjacent port (if the Altera PLD is used to loop the data). The software checks the receipt of packets to ensure they are received without error (i.e., the CRC is correct). For each HDLC channel that is enabled, the software also keeps track of the number of packets sent, number of packets received, number of packets received in error, and a variety of other statistics/counts.

2.3 Chat GUI

2.3.1 Main GUI Interface—Configuration

Figure 2-2. Software Main GUI

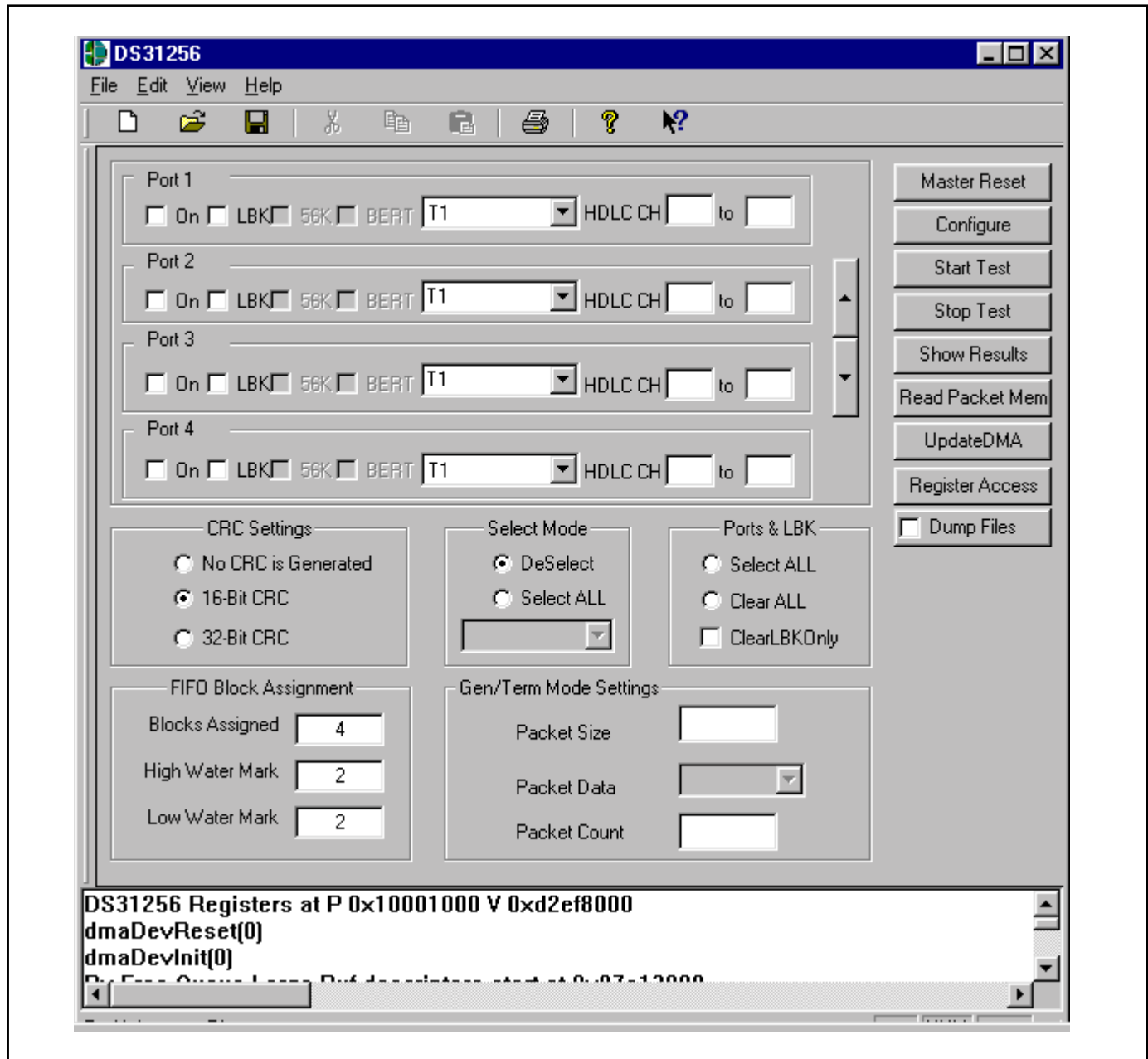

General Configuration

- The 16 ports on the Envoy are handled through a set of 16 check boxes. To save space on the screen, only four ports at a time are displayed. The user can scroll through the port boxes to access all 16 ports.

On

- The port number's box must be checked to be enabled. If this box is not checked, the software does not configure any of the RP[n]CR or TP[n]CR registers nor any of the R[n]CFG[j] and T[n]CFG[j] registers for that port.

LBK

- If this box is checked, the software sets the LLB bit (bit 10) in the RP[n]CR register to 1, configuring the port in loopback mode. If this box is not checked, the software clears the LLB bit.

T1

- Select the port mode from the drop-down box (same setting of the dip switch at the demo card):

T1	24 DS0 channels and 193 RC clocks between RS sync signals
E1	32 DS0 channels and 256 RC clocks between RS sync signals
4.096MHz	64 DS0 channels and 512 RC clocks between RS sync signals
8.192MHz	128 DS0 channels and 1024 RC clocks between RS sync signals
Unchannelized	One HDLC channel and no RS sync signals, speeds up to 10Mbps
Unch-HiSpeed	One HDLC high-speed channel and no RS sync signals (Ports 0–2 only), speeds up to 52MHz
- If one of the channelized modes (T1/E1/4.096MHz/8.192MHz) is chosen, the software configures the RSS0/RSS1 (bits 6, 7) and TSS0/TSS1 (bits 6, 7) in the RP[n]CR and TP[n]CR registers, respectively.
- If one of the unchannelized modes (Unchannelized/Unch-HiSpeed) is selected, the software sets the RUEN bit (bit 9) and the TUEN bit (bit 9) in the RP[n]CR and TP[n]CR registers, respectively, to 1.
- If the Unch-HiSpd mode (Ports 0–2 only) is selected, the software sets the RP0HS/RP1HS bit (bit 8) and the TP0HS/TP1HS bit (bit 8) in the RP[n]CR and TP[n]CR registers, respectively, to 1.

HDLC CH to

- The user can select from number 1 to 256 which HDLC channels are assigned to each port. If the user assigns the same HDLC channel to more than one port or inputs an invalid number, or the user assigns more than one HDLC channel to one port when one of the unchannelized modes (Unchannelized/Unch-HiSpeed) is selected, an error message is displayed when the Configure button is hit.
- If one of the channelized modes (T1/E1/4.096MHz/8.192MHz) is selected, the software uses the input from HDLC CH box to determine how to assign the time slots. The software divides the number of HDLC channels assigned into the number of time slots for the mode selected (i.e., 24 for T1, 32 for E1, 64 for 4.096MHz, and 128 for 8.192MHz) to determine how many time slots an HDLC channel occupies. It places the first HDLC channel for the port in the port's first time slot. All subsequent time slots are placed sequentially behind the previous one without a gap. If the result is a fraction, then a fraction of an HDLC channel fills the rest of the available bandwidth.

The table below shows an example of the T1 channel setting. Eight HDLC channels are assigned to port 1. Since there are 24 time slots in a T1 interface, the software divides 24 by 8 HDLC channels to get 3 time slots per HDLC channel and, therefore, it assigns 3 time slots (3 x 64kbps = 192kbps) for each HDLC channel. HDLC channel 2 is assigned to T1 time slots 0 to 2. HDLC channel 3 is assigned to T1 timeslots 3 to 5, and so on.

HDLC CHANNEL NUMBER	TIME SLOTS ASSIGNED	CHANNEL SPEED (kbps)
2	0 to 2	192
3	3 to 5	192
4	6 to 8	192
5	9 to 11	192
6	12 to 14	192
7	15 to 17	192
8	18 to 20	192
9	21 to 23	192

CRC Settings

No CRC is Generated

16-Bit CRC

32-Bit CRC

- The default CRC setting is 16-Bit CRC. The software sets the RCRC0/RCRC1 (bit 2, 3) and TCRC0/TCRC1 (bit 2, 3) in the RHCD and THCD registers, respectively.

Select Mode

DeSelect

Select ALL

T1

- DeSelect: The user can deselect the mode setting of all 16 ports at once instead of unchecking them one by one.
- Select All: The user can select a desired mode for all 16 ports once instead of checking it one by one. The mode list box is enabled when SelectAll is selected. The user selects the desired mode and the software configures all 16 ports with the selected mode.

Ports & LBK

Select ALL

Clear ALL

ClearLBKOnly

- Select All: All 16 ports and loopbacks are checked
- Clear All: All selected ports and loopbacks are unchecked
- ClearLBKOnly: All checked loopbacks are unchecked.

FIFO Block Assignment

Blocks Assigned

High Water Mark

Low Water Mark

Default value of blocks within the FIFO is 4. High and low watermarks are two (50% is the recommendation). The user can input the desired number.

- The software checks the maximum number of blocks that can be assigned, based on the following calculation. The full size of the FIFO is 1024 (minimum size is 4) blocks divided by the total number of HDLC channels being used.

$$\text{Blocks Assigned} = 1024 / \text{number of channels}$$

An error message displays if the user inputs the invalid number.

- Transmit high watermark can be set to a value of 1 to N - 2. Receive low watermark can be set to a value of 1 to N - 1. N is the number of blocks. (Refer to Section 8 in the DS31256 data sheet for details.)

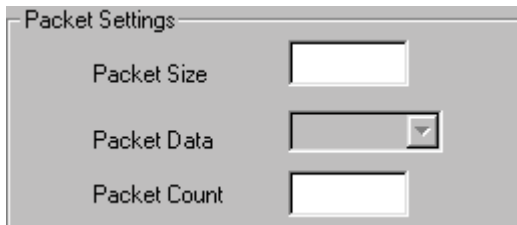

Packet Settings

Packet Size

Packet Data

Packet Count

- The user can input the desired packet size in byte and an integer packet count through the Packet Size and Packet Count edit boxes for his/her test. The Packet Size edit box defaults to 0x100 and the edit box of Packet Count defaults to 100 if the user does not input any numbers.

Control Descriptions

Master Reset

- Chat program sets the Envoy into a default state by issuing a software reset and then writing 0s into all indirect registers. The software also runs a register diagnostic to ensure it can correctly write and read all Envoy registers. The address of the buffer, descriptor, and queue are displayed in the message box when the process is done. If the diagnostic fails, the software creates an error message and displays it in the message box at the bottom of the main GUI interface.

Configure

- When this button is hit, the Chat program loads the Envoy registers with the settings in the GUI interface. "Successfully configured port #" is displayed in the message box if successful.

Start Test

- The program transmits and receives packets based on the user's selections. "Test Done" is displayed in the message box when the test is done.

Stop Test

- The user can stop the test any time. "Test stopped by user" is displayed in the message box when the user hits this button.

Show Results

- This brings up a screen ([Figure 2-3](#)) with detail information of the packet results.

Read Packet Mem

- This brings the Physical Memory Viewer screen up ([Figure 2-4](#)). The software prompts the user for an address, then it dumps the next 32 dwords to the screen. The user manually cancels the screen. This button is only active when a test is not being run.

UpdateDMA

- This brings up the DMA Configuration screen ([Figure 2-5](#)) for the user to configure the DMA by their desired values. Otherwise, the software uses default values to configure the DMA.

Register Access

- This brings up the Envoy Registers screen ([Figure 2-6](#)) for the user to read from or write into the register by hex number.

 Dump Files

- The software dumps the data of transmit and receive queues into a text file when it is checked.

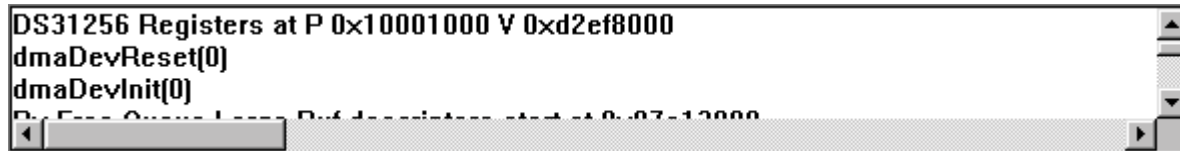

- The status of the process is displayed through the message box at the bottom of the main GUI.

File Menu Descriptions

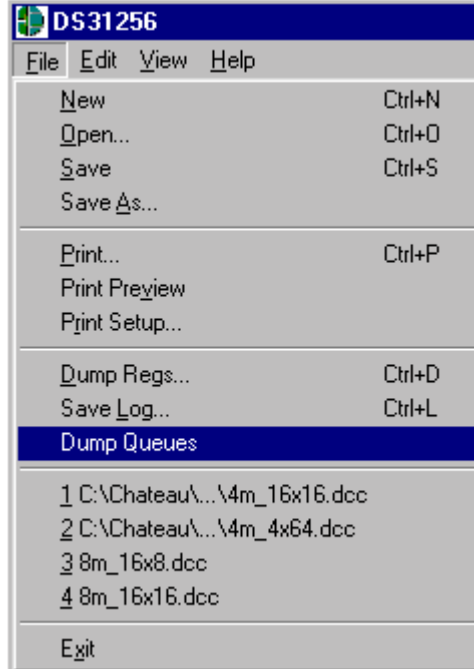

Open	All fields of the general configuration in the main GUI are filled from the file (that file should be saved by the software by Save under the File menu first).
Save	Copies all the selections from main GUI into a file when Save is selected.
Dump Regs	Saves the settings of all registers into a text file. The user can dump information at any time.
Save Log	Saves contents of the message box (at the bottom of the main GUI) into a text file.
Dump Queues	Dumps all queue data into a text file.

2.3.2 Show Results

Figure 2-3. Show Results GUI

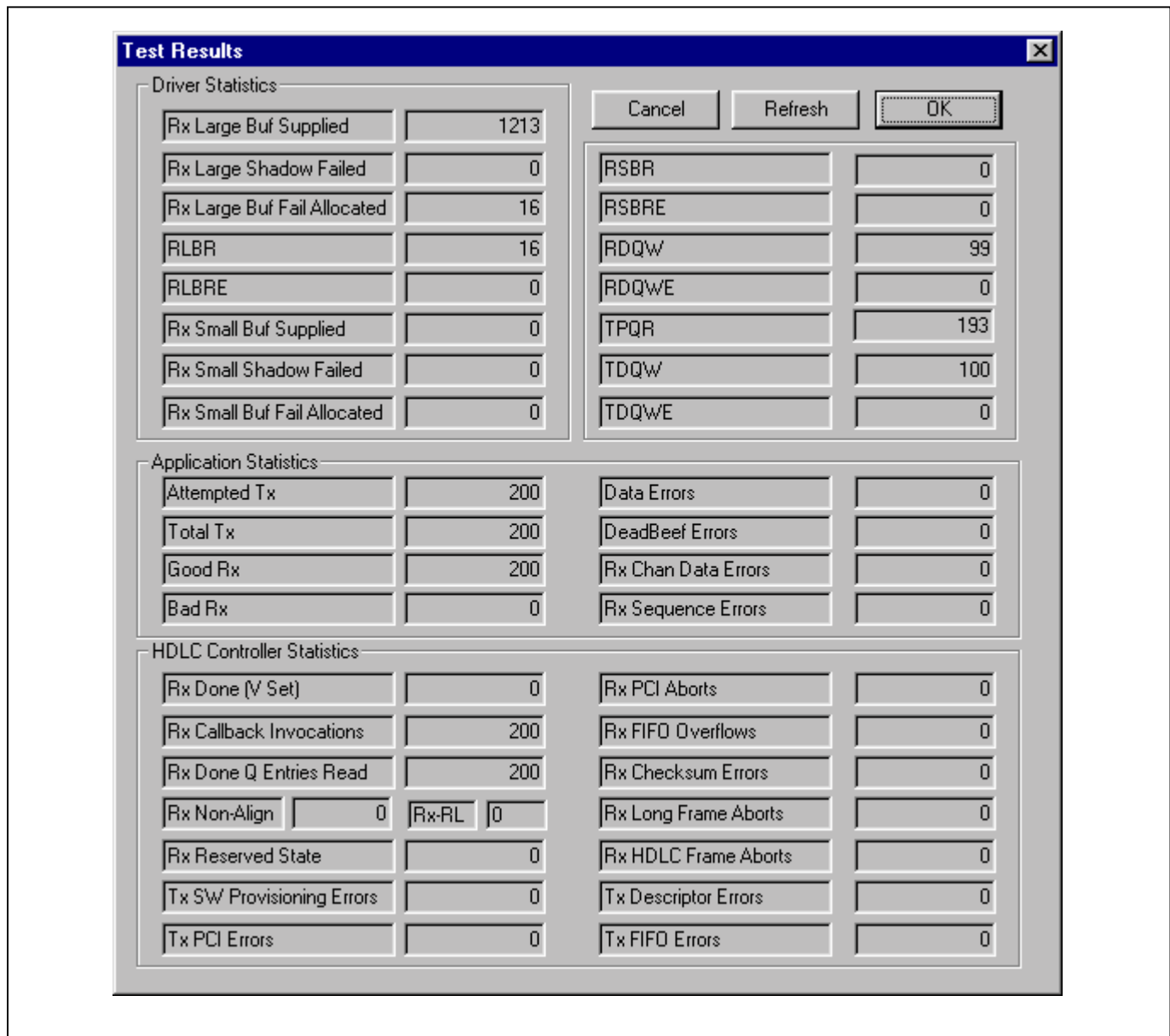

Descriptions of Driver Statistics

Rx Large Buffer Supplied	Number of Rx large buffers used
Rx Large Shadow Failed	Number of Rx large shadow creation failures
Rx Large Buf Fail Allocated	Number of Rx large buffer allocation failures
RLBR	Read from SDMA Bit 6
RLBRE	Read from SDMA Bit 7
Rx Small Buffer Supplied	Number of Rx small buffers used
Rx Small Shadow Failed	Number of Rx small shadow creation failures
Rx Small Buf Fail Allocated	Number of Rx small buffers allocation failures
RSBR	Read from SDMA Bit 8
RSBRE	Read from SDMA Bit 9
RDQW	Read from SDMA Bit 10
RDQWE	Read from SDMA Bit 11
TPQR	Read from SDMA Bit 13
TDQW	Read from SDMA Bit 14
TDQWE	Read from SDMA Bit 15

Descriptions of Application Statistics

Attempted Tx	Number of packet transmission attempted
Total Tx	Total number of packets transmitted
Good Rx	Number of packets received without error/problem
Bad Rx	Number of packets with errors
Data Errors	For program debugging
DeadBeef Errors	For program debugging
Rx Chan Data Errors	Number of packets with an incorrect channel number
Rx Sequence Errors	Number of packets with an incorrect sequence number

Descriptions of HDLC Controller Statistics

Rx Done Queue (V Bit)	Number of V set occurrences in receive done-queue descriptors
Rx Callback Invocations	For program debugging
Rx Done Queue Entries Read	Number of done-queue entries read
Rx-RL	Status bit for receive HDLC length check (RLENC) in SDMA register

The following seven items are read from receive done-queue descriptor, dword0, bits 27–29, reported at the final status of an incoming packet:

Rx FIFO Overflows	Remainder of the packet discarded
Rx Checksum Error	CRC checksum error
Rx Long Frame Aborts	Max packet length exceeded; remainder of the packet discarded
Rx HDLC Frame Aborts	HDLC frame abort sequence detected
Rx Non-Aligned Byte	Not an integral number of bytes
Rx PCI Aborts	PCI abort or parity data error
Rx Reserved State	Not a normal device operation event

The following four items are read from transmit done-queue descriptor, dword0, bits 26–28, reported at the final status of an outgoing packet:

Tx SW Provisioning Errors	Channel was not enabled.
Tx PCI Errors	PCI errors; abort
Tx Descriptor Errors	Either byte count = 0 or channel code inconsistent with pending queue
Tx FIFO Errors	Underflow events

2.3.3 Memory Viewer

Figure 2-4. Memory Viewer GUI

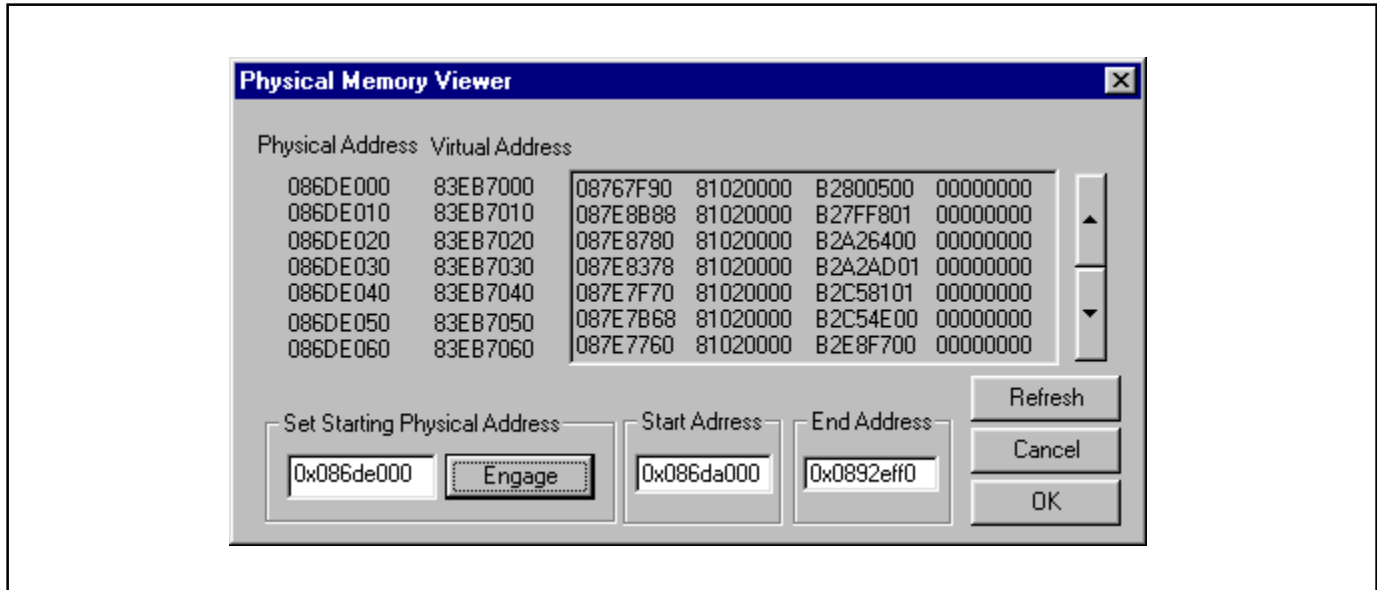

The physical memory viewer shows all the data within the start and end address space that is allocated by the Chat program. The user can step through memory by the address box or by using the scroll up/down buttons on the right.

Fields Descriptions

Start Address	Display the starting address of the DMA that the program allocated in the memory
End Address	Display the ending address of the DMA that the program allocated in the memory

Control Descriptions

Engage	User can look at any address within the range of Start Address and End Address through the edit box;. (Input the desired physical address) and then hit the Engage button. All data displayed starts from the input physical address.
---------------	---

2.3.4 DMA Configuration

Figure 2-5. DMA Configuration GUI

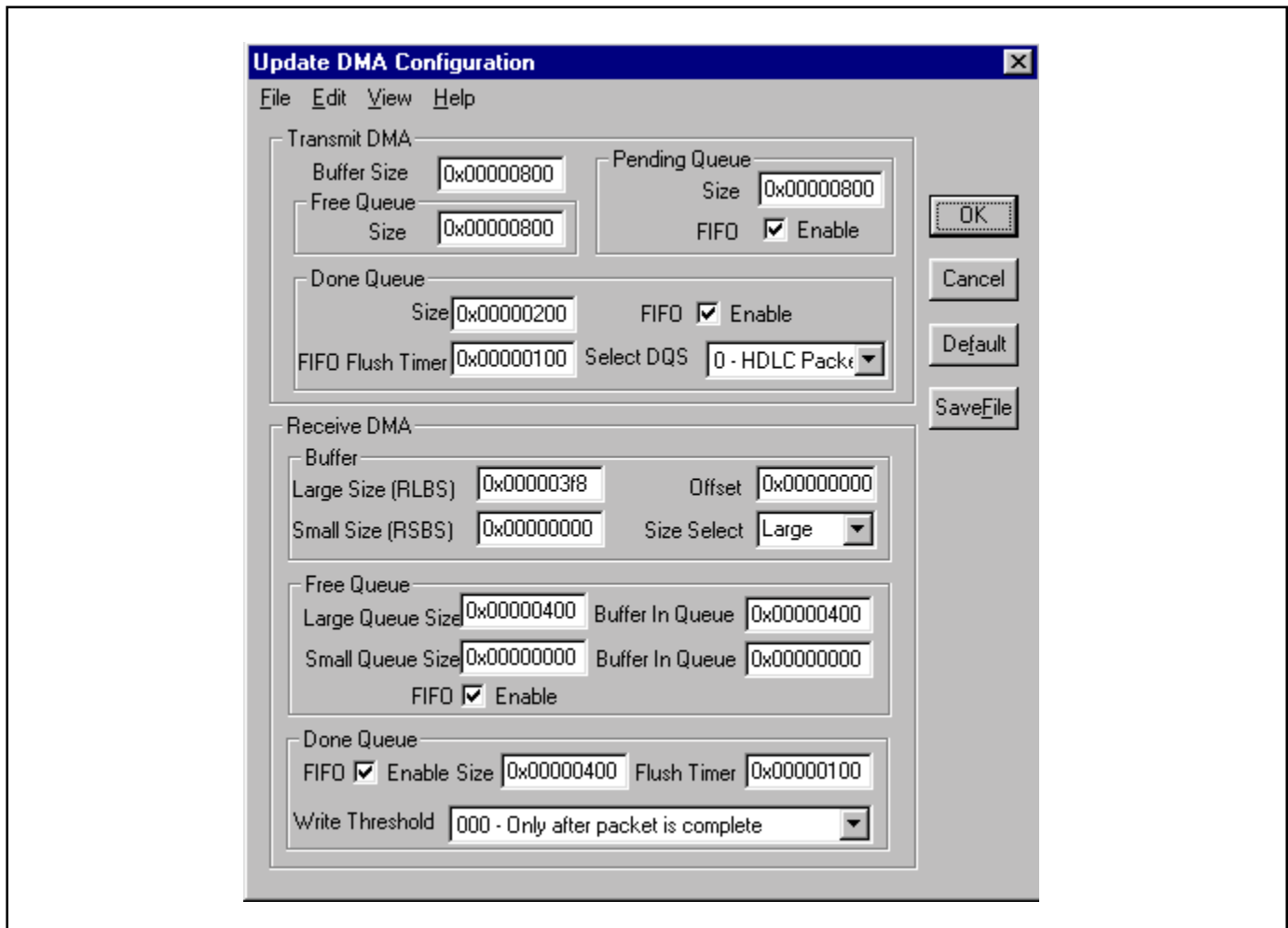

The DMA configuration displays default values at first, then the user can change the desired value and hit the Master Reset. The DMA in Envoy can read from the receive free queue and transmit pending queue as well as write to the receive done queue and transmit done queue. Therefore, each access of the descriptor queues are done one at a time, and sequentially.

Descriptions of Transmit DMA

Buffer Size	Size of the transmit buffer side; maximum value = 0x1fff
Free Queue Size	Number of free queues maximum value = 0xffff
Pending Queue	Size: Size of pending queue, maximum = 0x10000; FIFO: Enable/disable FIFO (TDMAQ bit 0)
Done Queue	Size: Size of done queue in transmit DMA, maximum value = 0x10000 FIFO: Enable/disable FIFO (TDMAQ bit 2) Flush Timer: TDQFFT, maximum value = 0xffff Select DQS: HDLC packet (transmit DMA configuration RAM dword1, bit 1)

Descriptions of Receive DMA

Buffer	Large: RLBS register; maximum value = 0x1fff Small: RSBS register; maximum value = 0x1fff Offset: Receive DMA configuration RAM, dword2, bits 3–6 Size Select: Receive DMA configuration RAM dword2, bits 1 and 2
Free Queue	Large: Size of free queue for large buffer Buffer in Queue: Number of buffers to put into the free queue Small: Size of free queue for large buffer Buffer in Queue: Number of buffers to put into the free queue Maximum value of the free queue = 0x10000 (large + small) FIFO: Enable/disable FIFO (RDMAQ, bit 0)
Done Queue	Size: Size of receive done queue, maximum value = 0x10000 FIFO: Enable/disable FIFO (RDMAQ, bit 4) Flush Timer: RDQFFT, maximum value = 0xffff Threshold: Receive DMA configuration RAM, dword2, bits 7–9

Control Descriptions

OK	The DMA settings are updated with the value from all fields.
SaveFile	Saves all the information from the GUI into a file.
Default	Restores all fields to Envoy default values.

2.3.5 Register Access

Figure 2-6. Registers Access GUI

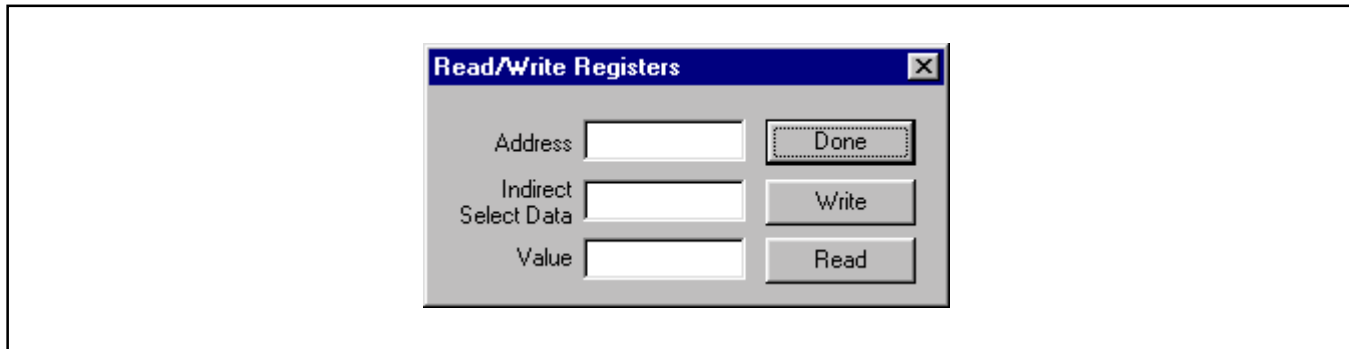

Field Descriptions

Register Address	Address of data register to read/write.
Indirect Select Data	If the address is the indirect select register, user needs to input the value.
Value	Display the value from the register when Read button is hit or specify the value to write into the register when Write button is hit.

Control Descriptions

Done	Close the screen.
Write	Prompt the user for which register address to write and the value to be written and then it writes to the register.
Read	Prompt the user for which register address to read and then it reads the register and return the value.

2.4 Driver

The low-level API, or driver, shown in layer 2 of [Figure 2-1](#) may be used as a starting point in systems development to speed time to market. Low-level API source blocks are summarized in [Table 2-A](#), and relate to one another structurally as shown in [Figure 2-7](#). Note also in this figure a grouping of three particular source files: 3134.c, syswd.c, and wd.c. These are the files that must undergo modifications if the WinDriver package is not deployed in the target system.

Table 2-A. Low-Level API Source Block Contents

SOURCE FILE	CONTENT/PURPOSE
syswd.c	Interface code to WinDriver; system and memory management functions
hdlc.c	Channel management functions
l1.c	Port management and BERT functions
drv.c	Register management functions
services.c	Bit manipulation functions
3134.c	WinDriver-generated PCI management functions
wd.c	Generated WinDriver code

Section [4](#) (*Appendix A*) contains reference tables listing all of the functions in each of the above code blocks. Note that some of the data structures are elaborate, and that they are defined in the header files. Usage examples can be found in the Chat demonstration code.

Figure 2-7. Low-Level API Source Block Relationships

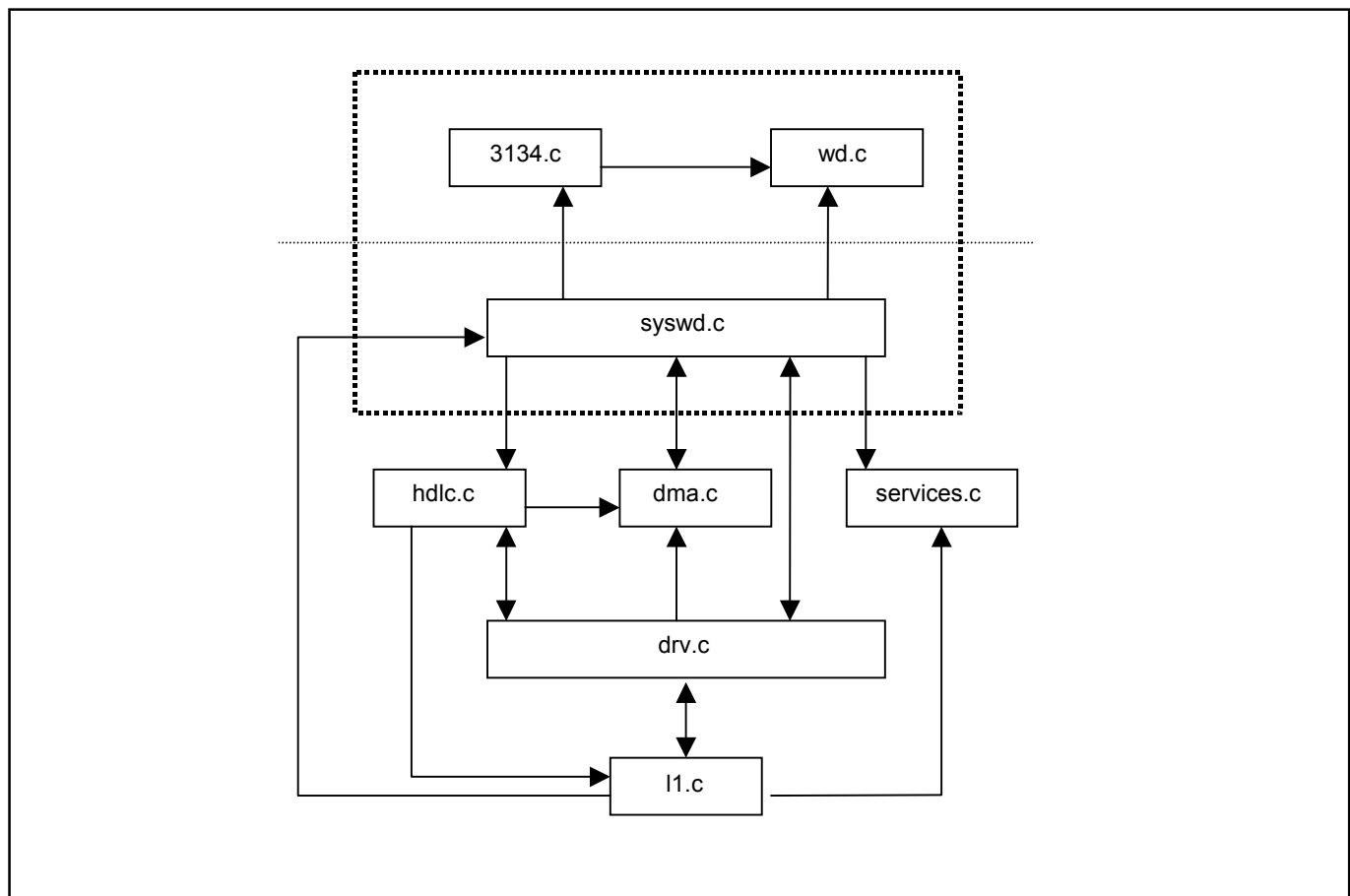

3. INSTALLATION AND GETTING STARTED

Please contact telecom.support@dalsemi.com or call 972-371-6555 if you have any technical questions, or visit our website at www.maxim-ic.com/telecom.

3.1 Card Installation

Separate instructions for Win95, Win98, and WinNT Systems.

3.1.1 Windows 95 Systems

- 1) Power-down the host computer system, and open its case. Follow ESD precautions while in contact with the card, the DS31256, and system components.
- 2) If not already seated, install the DS31256 chip into the BGA socket on the DK's PC board.
- 3) Set the DIP switches on the card to configure the board and operational mode ([Figure 1-2](#)).
- 4) Plug the DS31256DK card into an empty PCI slot.
- 5) Reassemble the computer.
- 6) Boot the computer.
- 7) Insert the DS31256DK1 CD.
- 8) Open a DOS window to perform the following commands:
 - Change directory to c:\windows\system\vm32.
 - Copy the file *windrvr.vxd* from the CD "Install\Win95" directory to c:\windows\system\vm32.
 - Copy the file *wdreg.exe* from the CD "Install\Win95" directory to c:\windows\system\vm32.
 - Run *wdreg -vxd install* from the DOS prompt in the current working directory.
 - Close the DOS shell and reboot the machine.

3.1.2 Windows 98 Systems

- 1) Power-down the host computer system, and open its case. Follow ESD precautions while in contact with the card, the DS31256, and system components.
- 2) If not already seated, install the DS31256 chip into the BGA socket on the DK's PC board.
- 3) Set the DIP switches on the card to configure the board and operational mode ([Figure 1-2](#)).
- 4) Plug the DS31256DK card into an empty PCI slot.
- 5) Reassemble the computer.
- 6) Boot the computer and do not allow the system to search for or install drivers for the new hardware.
- 7) Insert the DS31256DK1 CD.
- 8) Open a DOS window to perform the following commands.:
 - Change directory to c:\windows\system\vm32.
 - Copy the file *windrvr.sys* from the CD "Install\Win98" directory to c:\windows\system32\drivers.
 - Copy the file *wdreg.exe* from the CD "Install\Win98" directory to c:\windows\system32\drivers.
 - Run *wdreg install* from the DOS prompt in the current working directory.
 - Close the DOS shell and reboot the machine.

3.1.3 Windows NT Systems

- 1) Power-down the host computer system, and open its case. Follow ESD precautions while in contact with the card, the DS31256, and system components.
- 2) If not already seated, install the DS31256 chip into the BGA socket on the DK's PC board.
- 3) Set the DIP switches on the card to configure the board and operational mode ([Figure 1-2](#)).
- 4) Plug the DS31256DK card into an empty PCI slot.
- 5) Reassemble the computer.
- 6) Boot the computer.
- 7) Insert the DS31256DK1 CD.
- 8) Open a DOS window to perform the following commands:
 - Change directory to c:\winnt\system.
 - Copy the file *windrvr.sys* from the CD "Install\WinNT" directory to c:\winnt\system32\drivers.
 - Copy the file *wdreg.exe* from the CD "Install\WinNT" directory to c:\winnt\system32\drivers.
 - Run *wdreg install* from the DOS prompt in the current working directory.
 - Close the DOS shell, and reboot the machine.

3.2 Software Installation

- 1) Make a directory on the system.
- 2) Copy Chat.exe from the CD "Install\<OS_Type>" to the target directory.
- 3) Create a shortcut to the program, or set up a menu entry for it.

Note: The source code for Chat and the underlying drivers is in the CD "Source" directory. If desired, the source directory can also be copied off of the CD to the host.

3.3 Operational Test

After performing the card and software installations as described above,

- 1) Ensure that the board's DIP switches are set as follows:

1	2	3	4	5	6	7	8	9	10
On	On	Off	On	On	Off	Off	Off	Off	Off

- 2) Execute the Chat.exe program.
- 3) Click the On and LBK checkbox for Port 1.
- 4) Make sure the Port 1 pulldown selector is set to T1 mode.
- 5) Set the Port 1 channel range from 1 to 24 HDLC CH to .
- 6) Set both the Packet Size and Packet Count to 100.

Packet Size	<input type="text" value="100"/>
Packet Count	<input type="text" value="100"/>

- 7) Click the button.
- 8) Click the button. This results in a message stating "Successfully configured Port 1."
- 9) Click the button. The message "Starting test with 100 packets" appears. The message "Test Done" prints when complete.
- 10) Next, click the button. In the Application Statistics portion of the results window the following data (part of them) will appear:

Attempted Tx	100
Total Tx	100
Good Tx	100
Bad Tx	0

4. APPENDIX A

syswd.c System Services (Generated Code; see WinDriver Developer's Guide)			
FUNCTION	PURPOSE	RETURNS	
SysDevOpen	Open a particular card/device on PCI	int32	
SysDevClose	Disable interrupts, unregister a card, and close the driver	int32	
SysIntInit	Configure ISR	Nothing	
SysCrash	System crash error handler	Nothing	
SysFail	System failure handler	Nothing	
SysRxBufAlloc	Allocate receive large buffer	drvRxBuf *	
SysRxSmBufAlloc	Allocate receive small buffer	DrvRxBuf *	
SysRxBufFree	Free receive large buffer	Nothing	
SysRxSmBufFree	Free receive small buffer	Nothing	
sysRxBufLastFree	Free the buffer in final	Nothing	
sysTxBufAlloc	Allocate transmit buffer	drvTxBuf *	
sysTxBufFree	Free transmit buffer	Nothing	
sysDevWrReg16	Writes a word to an address space on the board	Nothing	
sysDevRdReg16	Reads a word from an address space on the board	int32	
sysIntDisable	Lock out interrupt thread	int32	
sysIntEnable	Enable interrupt processing	Nothing	
sysMemAlloc	Allocate virtual memory	void *	
sysMemFree	Free virtual memory	Nothing	
sysContAlloc	Allocate continuous memory block and map to phys. mem	void *	
sysContFree	Release a continuous memory block	Nothing	
locateAndOpenBoard	Locate the 3134 card on the PCI bus, open it, return handle	static DS3134_HANDLE	
closeBoard	Close the 3134 board whose handle is passed	Nothing	
sysIntHandler	Read SDMA register; then call ISR if it is not zero	Nothing	
sysClearCrashMsg	Clear out the crash message buffer	Nothing	
SysGetCrashMsg	System receive crash message	Nothing	
sysGetVmemBase	Get virtual memory base address	unsigned long	
sysGetPmemBase	Get physical memory base address	unsigned long	
sysV2P	Convert virtual address to physical address	unsigned long	
sysP2V	Convert physical address to virtual address	unsigned long	

hdlc.c HDLC Functions		
FUNCTION	PURPOSE	RETURNS
hdlcDevReset	Reset the device and its data (not called directly)	Nothing
hdlcDevOff	Turn the device off (not called directly)	Nothing
hdlcChanOpen	Open a channel with specified parameters	Nothing
hdlcChanClose	Close a channel	Nothing
hdlcChanGetState	Return the status of the channel	TRUE if open, FALSE otherwise
hdlcChanTrafficCtrl	Control a channel's traffic	Nothing
hdlcChanSetDs0Bits	Set bits for all Ds0 of the channel	Nothing
hdlcChanClearDs0Bits	Clear bits for all Ds0 of the channel	Nothing
drv.c Driver Level Functions		
FUNCTION	PURPOSE	RETURNS
drvGetVmemBase	Get virtual memory base address (calls to syswd.c)	unsigned long
drvGetPmemBase	Get physical memory base address (calls to syswd.c)	unsigned long
drvVAddr2Paddr	Convert virtual address to physical addr (calls to syswd.c)	unsigned long
drvPAddr2Vaddr	Convert physical address to virtual addr (calls to syswd.c)	unsigned long
drvWriteReg	Write a value into a device register	TRUE (success) FALSE (failure)
drvReadReg	Read a value from a device register	-1 on failure or the reg value on success
drvWritelReg	Write a value into an indirect register	TRUE (success) FALSE (failure)
drvReadlReg	Read a value from an indirect register	-1 on failure or the int32 reg value on success
drvDevInit	Reset and initialize the device	FALSE if device does not exist
drvDevOff	Put the device in reset	Nothing
drvWriReg	Write to an indirect register	Nothing
drvRdlReg	Read from an indirect register	int32 Register value
drvInitlRegs	Write a zero to an indirect register	Nothing
drvIntCallback	The interrupt callback from the ISR (only DMA int.s today)	Nothing
DrvGetlSrStats	Get a pointer to the interrupt service routine stats	drvlSrStats *
drvInitlRegs	Write a zero to all indirect registers of the device	Nothing
DrvGetdmaDesc	Get a pointer to the structure describing DMA configuration	DrvDmaDesc *
DrvUpdatedmaDesc	Get a pointer to the structure of DMA updated configuration	DrvDmaDesc *

L1.c Layer 1-Related Functions			
FUNCTION	PURPOSE	RETURNS	
I1DevReset	Reset the device and its data (not called directly)	Nothing	
I1DevOff	Turn Layer 1 port off (not called directly)	Nothing	
I1PortDisable	Disable a port	Nothing	
I1PortInit	Configure a port with static parameters	Nothing	
I1PortWriteDParam	Configure dynamic params of a port: copy from param	Nothing	
I1PortSetDParamBits	Configure dynamic params of a port: set params corresponding to non-zero bits in param	Nothing	
I1PortClearDParamBits	Configure dynamic params of a port: reset params corresponding to non-zero bits in param	Nothing	
I1PortAllocateDs0	Set status specified by param, and HDLC channel number to all DS0s specified by tsMap and associate these ds0 with the port	Nothing	
I1PortSetDs0Bits	Set status specified by nonzero bits of param to all DS0s specified by bitMap	Nothing	
I1PortClearDs0Bits	Clear status specified by nonzero bits of param to all DS0s specified by bitMap	Nothing	
I1PortFreeDs0	Disconnect the DS0 specified by bitMap from being associated with a port	Nothing	
I1PortReadStatus	Read port status and present it as a bitmap	Port status, int32 bitmap	
I1PortResetV54	Reset V.54	Nothing	
I1PortUnchannelizedWorkAround	Fix needed when emulating unchannelized, low speed using 8M mode	Nothing	
I1BertWriteParam	Set miscellaneous BERT parameters	Nothing	
I1BertSetParamBits	Set miscellaneous BERT parameters defined by nonzero bits of param	Nothing	
I1BertClearParamBits	Set miscellaneous BERT parameters defined by nonzero bits of param	Nothing	
I1BertLatchCounters	Get value of counters into local storage and start a new count	Nothing	
I1BertReadCounter	Read last latched value of counter from local storage	counter value (4 Bytes), uint32	
I1BertSetPattern	Set pattern transmission	Nothing	
I1BertSingleErrorInsertion	Insert single bit error	Nothing	

dma.c		DMA Functions	
FUNCTION	PURPOSE	RETURNS	
DmaDevReset	Reset the device and its data (not called directly)	Nothing	
DmaDevOff	Turn the device off	Nothing	
DmaDevInit	Initialize the device	TRUE/success, FALSE/not enough resources	
DmaDoRxReplenish	Give the Rx DMA as many receive large buffers as it can handle (not called directly)	Nothing	
MaDoSmRxReplenish	Give the Rx DMA as many receive small buffers as it can handle (not called directly)	Nothing	
DmaReplenishRxBuffers	Give the Rx DMA as many receive buffers as it can handle (not called directly)	Nothing(calls dmaDoRxReplinish)	
dmaCtrl	Enable or disable DMA	Nothing	
DmaChanSend	Submit packet chain to be transmitted	Nothing	
DmaRxChanCtrl	Set DMA RAM for the channel as appropriate	Nothing	
DmaTxChanCtrl	Set DMA RAM for the channel as appropriate	Nothing	
DmaEventRLBR	Rx large buffer read event, called by the ISR	Nothing	
DmaEventRLBRE	Rx large buffer read error event, called by the ISR	Nothing	
DmaEventRSBR	Rx small buffer read event, called by the ISR	Nothing	
DmaEventRSBRE	Rx small buffer read error event, called by the ISR	Nothing	
DmaEventRDQW	Rx done-queue write event, called by the ISR	Nothing	
DmaEventRDQWE	Rx done-queue write error event, called by the ISR	Nothing	
DmaEventTPQR	Tx pending-queue read event, called by the ISR	Nothing	
DmaEventTDQW	Tx done-queue write event, called by the ISR	Nothing	
DmaEventTDQWE	Tx done-queue write error event, called by the ISR	Nothing	
dmaTxPkt	Put a single packet into pending queue	TRUE if new pending Q element is reuquired	
DmaGetTxStats	Get a pointer to the Tx DMA stats	txDmaStats *	
DmaGetRxStats	Get a pointer to the Rx DMA stats	RxDmaStats *	
DrvGetdmaTxDev	Get a pointer to the structure of DMA Tx subsystem of the device	dmaTxDev *	
DrvGetdmaRxDev	Get a pointer to the structure of DMA Rx subsystem of the device	dmaRxDev *	

services.c General Services

FUNCTION	PURPOSE	RETURNS
bitMapRead	Read the value of a specific bit	0 or 1, int32
bitMapWrite	Write the value of a specific bit	Nothing
bitMapLogicalAnd	Test for common set (=1) bits between two parameters	True if commonalities, else or False (int32)
bitMapLogicalEq	Test two parameters for equivalence	True if equal, else False (int32)
bitMapLogicalSubset	Test to see if parameter 2 is a subset of parameter 1	True if subset, else False (int32)
bitMapSetBits	Set all bits in parameter 1 that are set in parameter 2	Nothing
bitMapClearBits	Clear all bits in parameter 1 that are set in parameter 2	Nothing
BitMapIsEmpty	Test to see if any bits are set in parameter 1	True if all bits = 0, else False (int32)
BitMapSetRange	Set a range of bits in parameter 1	Nothing
BitMapClearRange	Clear a range of bits in parameter 1	Nothing

ds3134.c DS3134 Card Access Functions (Generated Code; see WinDriver Developer's Guide)

FUNCTION	PURPOSE	RETURNS
DS3134_CountCards	Scan PCI and count the number of a certain type of card	Card count, DWORD
DS3134_Open	Open a particular card/device on PCI	True is succesful, else False
DS3134_Close	Disable interrupts, unregister a card, and close the driver	Nothing
DS3134_WritePCIReg	Write to a PCI configuration register	Nothing
DS3134_ReadPCIReg	Read from a PCI configuration register	Register value, DWORD
DS3134_DetectCardElements	Check availability of card info: interrupts, I/O, memory	True if all are found, else False
DS3134_IsAddrSpaceActive	Check if specified address space is active	True if active, else False
DS3134_ReadWriteBlock	Perform general block reads and writes	Nothing
DS3134_ReadByte	Reads a byte from an address space on the board	Byte
DS3134_ReadWord	Reads a word from an address space on the board	Word
DS3134_ReadDword	Reads a DWORD from an address space on the board	DWORD
DS3134_WriteByte	Writes a byte to an address space on the board	Nothing
DS3134_WriteWord	Writes a word to an address space on the board	Nothing
DS3134_WriteDword	Writes a DWORD to an address space on the board	Nothing
DS3134_GetRegAddr	Get register address	Dword of 0 if found, else 1
DS3134_IntIsEnabled	Checks whether interrupts are enabled or not	True if enables, else False
DS3134_IntHandler	Configure interrupt event handling (indirectly called)	Nothing
DS3134_IntEnable	Enable interrupt processing	True is successfully configured, else False
DS3134_IntDisable	Disable interrupt processing	Nothing

Maxim/Dallas Semiconductor cannot assume responsibility for use of any circuitry other than circuitry entirely embodied in a Maxim/Dallas Semiconductor product. No circuit patent licenses are implied. Maxim/Dallas Semiconductor reserves the right to change the circuitry and specifications without notice at any time.

Maxim Integrated Products, 120 San Gabriel Drive, Sunnyvale, CA 94086 408-737-7600

© 2003 Maxim Integrated Products • Printed USA

NOTES: UNLESS OTHERWISE SPECIFIED

1. MATERIAL: FR4
2. THICKNESS: .062 +/-10% AFTER PLATING
3. BUILD/MANUFACTURE TO BEST COMMERCIAL STANDARDS
4. COPPER EXTERNAL: 1/2 OUNCE, PLATED UP TO 1 OUNCE
5. COPPER INTERNAL: 1 OUNCE
6. HOLE SIZES ARE FINISHED SIZE
7. MINIMUM CONDUCTOR WIDTH: .005
8. MINIMUM CONDUCTOR SPACING: .005
9. SOLDERMASK: 1.0% (BOTH SIDES) WITH EXPOSED SOLDER AREAS SOLDER COATED
183/97 TIN LEAD) AND LEVELLED
10. GOLD PLATE CONDUCTOR FINGERS USING STANDARD GOLD PLATING PROCESS.
11. SILKSCREEN TOP AND BOTTOM OF BOARD WHITE USING ARTWORKS SUPPLIED

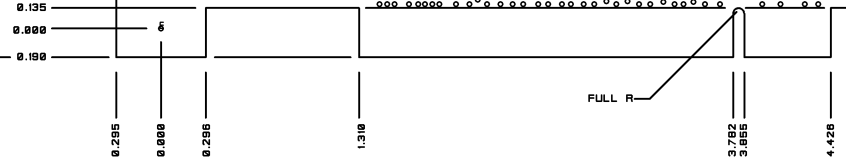
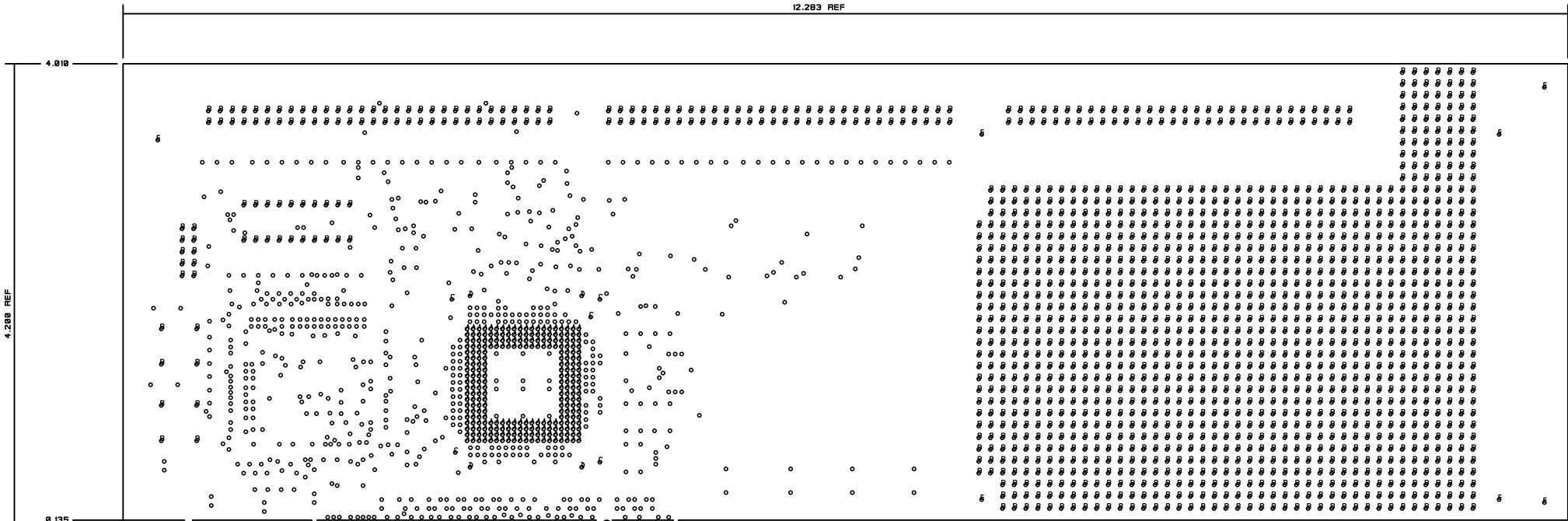
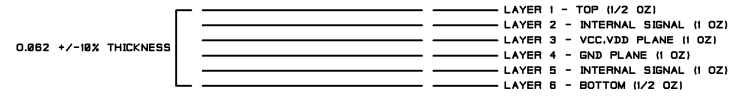

DALLAS SEMICONDUCTOR
DS3134 DEMO BOARD REV A
FABRICATION DRAWING

Size	Letter	Count
.018	@	707
.022	A	256
.035	B	1483
.064	C	5
.098	D	4
.125	E	8