

RoHS Compliant Product

Description

The SSC2139 positive, linear regulators feature low quiescent current (45µA typ.) with low dropout voltage, making them ideal for battery applications. Output voltage are set at the factory and trimmed to 1.5% accuracy. These rugged devices have both Thermal Shutdown and Current Fold-back to prevent device failure under the "Worst" of operating conditions. The SSC2139 is stable with an output capacitance of 4.7µF or greater.

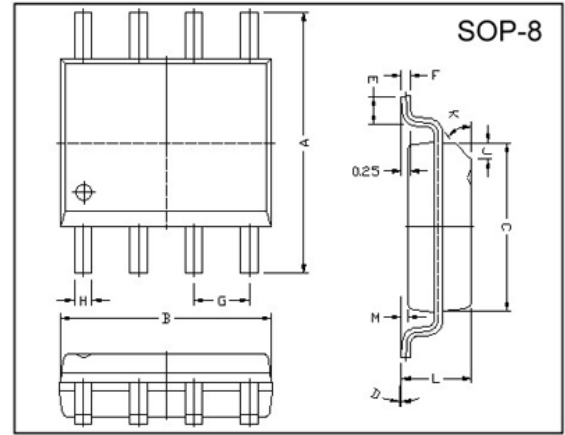

REF.	Millimeter		REF.	Millimeter	
	Min.	Max.		Min.	Max.
A	5.80	6.20	M	0.10	0.25
B	4.80	5.00	H	0.35	0.49
C	3.80	4.00	L	1.35	1.75
D	0	8	J	0.375 REF.	
E	0.40	0.90	K	45°	
F	0.19	0.25	G	1.27 TYP.	

Features

- * Low Temperature Coefficient
- * Over-Temperature Shutdown
- * Adjustable Version
- * Very Low Dropout Voltage
- * High Accurate ±1.5%
- * Guaranteed 1.55A output
- * Current Limiting
- * Power-Saving Shutdown Mode

Applications

- * PC Peripherals
- * Wireless Devices
- * Portable Electronics
- * Battery Powered Widgets
- * Instrumentation

Typical Application Circuit

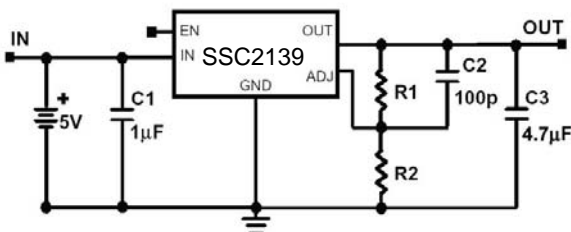

Marking :

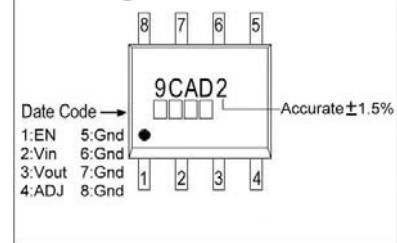

Functional Block Diagram

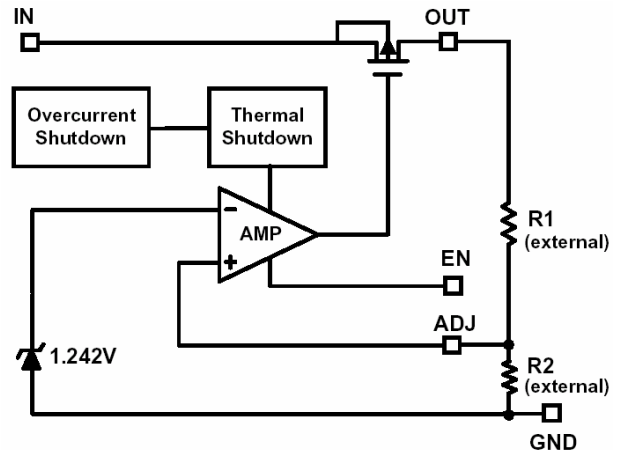



Elektronische Bauelemente

SSC2139

1.55A CMOS

Low Dropout Voltage Regulator

Absolute Maximum Ratings

Parameter	Symbol	Ratings	Unit
Input Voltage	V_{IN}	8	V
Output Current	I_{OUT}	$P_D/(V_{IN}-V_O)$	mA
Output Voltage	V_{OUT}	Gnd-0.3 to $V_{IN}+0.3$	V
Operating Ambient Temperature	T_{opr}	-40~+85	°C
Junction Temperature	T_j	-40~+125	°C
Max. Junction Temperature	$T_j \text{ Max.}$	150	°C
Power Dissipation ($\Delta T=100^\circ\text{C}$)	P_D	810	mW
EDS Classification		B	

Electrical Characteristics $T_a=25^\circ\text{C}$ unless otherwise noted ($V_{IN}=V_{OUT}(T)+2V, V_{EN}=V_{IN}$)

Parameter	Symbol	Min.	Typ.	Max.	Unit	Condition
Output Voltage	$V_{OUT}(E)^1$	-1.5%	$V_{OUT}(T)^2$	1.5%	V	$I_o=1\text{mA}$
Output Current	I_o	1.55	-	-	A	$V_o>1.2V$
Current Limit	I_{LIM}	1.55	2.0	-	A	$V_o>1.2V$
Load Regulation	REG_{LOAD}	-1	0.2	1	%	$I_o=1\text{mA}\sim 1.5A$
Dropout Voltage	$V_{DROPOUT}$	-	-	1000	mV	$1.5V < V_{OUT}(T) \leq 2.0V$
		-	-	800		$2.0V < V_{OUT}(T) \leq 2.8V$
		-	-	600		$2.8V < V_{OUT}(T)$
						$I_o=1.55A$ $V_o=V_{OUT}(E)-2\%$
Ground Pin Current	I_{GND}	-	45	-	uA	$I_o=1\text{mA}\sim 1.5A$
Line Regulation	REG_{LINE}	-	-	0.15	%	$V_{OUT}(T) < 2.0V$
		-	0.02	0.1		$2.0V \leq V_{OUT}(T)$
						$I_o=1\text{mA}$ $V_{IN}=V_{OUT}(T)+1$ to $V_{OUT}(T)+2$
Input Voltage	V_{IN}	Note ³	-	7	V	
Over Temperature Shutdown	O_{TS}	-	150	-	°C	
Over Temperature Hystersis	O_{TH}	-	30	-	°C	
Output Voltage Temperature Coefficient	T_C	-	30	-	ppm/°C	
Power Supply Rejection	PSRR	-	50	-	dB	f=1kHz
		-	20	-		f=10kHz
		-	15	-		f=100kHz
						$I_o=100\text{mA}$ $C_o=4.7\mu\text{F}$ (ceramic)
Output Voltage Noise	eN	-	30	-	uVrms	f=10Hz~100kHz, $I_o=10\text{mA}$ $C_o=4.7\mu\text{F}$
EN Input Threshold	V_{EH}	2	-	V_{IN}	V	$V_{IN}=2.7V$ to 7V
	V_{EL}	0	-	0.4		
EN Input Bias Current	I_{EH}	-	-	0.1	uA	$V_{EN}=V_{IN}, V_{IN}=2.7V\sim 7V$
	I_{EL}	-	-	0.5		$V_{EN}=0V, V_{IN}=2.7V\sim 7V$
Shutdown Supply Current	I_{SD}	-	30	-	uA	$V_{IN}=5V, V_o=0, V_{EN}<V_{EL}$
		-	0.5	2		$V_{IN}=2.5V, V_o=0, V_{EN}<V_{EL}$
ADJ Input Bias Current	I_{ADJ}	-	1	-	uA	$V_{IN}=5V, V_{ADJ}=1.242V$
ADJ Reference Voltage	V_{REF}	1.223	1.242	1.261	V	

Note 1: $V_{OUT}(E)$ =Effective Output Voltage (i.e. the output voltage when " $V_{OUT}(T)+2.0V$ " is provided at the V_{IN} pin while maintaining a certain I_{OUT} value).

2: $V_{OUT}(T)$ =Specified Output Voltage

3: $V_{IN}(MIN) = V_{OUT} + V_{DROPOUT}$

Ordering Information(contd.)

Part Number	Marking	Output Voltage	Part Number	Marking	Output Voltage
SSC2139-AD	9CAD2 XXXX	Adjustable			

Detailed Description

The SSC2139 of COMS regulators contain a PMOS pass transistor, voltage reference, error amplifier, over-current protection and thermal shutdown. The P-channel pass transistor receives data from the error amplifier, over-current shutdown, and thermal protection circuits. During normal operation, the error amplifier compares the output voltage to a precision reference. Over-current and Thermal shutdown circuits become active when the junction temperature exceeds 140°C, or the current exceeds 2.2A. During thermal shutdown, the output voltage remains low. Normal operation is restored when the junction temperature drops below 120° C.

External Capacitors

The SSC2139 is stable with an output capacitance to ground of 4.7uF or greater. Ceramic capacitors have the lowest ESR, and will offer the best AC performance. Conversely, Aluminum Electrolytic capacitors exhibit the highest ESR, resulting in the poorest AC response. Unfortunately, large value ceramic capacitors are comparatively expensive. One option is to parallel a 0.1uF ceramic capacitor with a 10uF Aluminum Electrolytic. The benefit is low ESR, high capacitance, and low overall cost. A second capacitor is recommended between the input and ground to stabilize V_{IN} . The input capacitor should be at least 0.1uF to have a beneficial effect. All capacitors should be placed in closed proximity to the pins. A "Quiet" ground termination is desirable. This can be achieved with a "Star" connection.

Enable

When EN pin is pulled low, the PMOS pass transistor shuts off, and all internal circuits are powered down. In this state, the quiescent current is less than 2uA. This pin behaves much like an electronic switch.

Adjustable Version

The adjustable version uses external feedback resistors to generate an output voltage anywhere from 1.5V to 5.0V. V_{adj} is trimmed to 1.242V and V_{out} is given by the equation:

$$V_{out} = V_{adj} * (1 + R1/R2)$$

Feedback resistors R1 and R2 should be high enough to keep quiescent current low, but increasing R1+R2 will reduce stability. In general, R1 and R2 in the 10's of kΩ will produce adequate stability, given reasonable layout precautions. To improve stability characteristics, keep parasitic on the ADJ pin to min., and lower R1 and R2 values.

Characteristics Curve

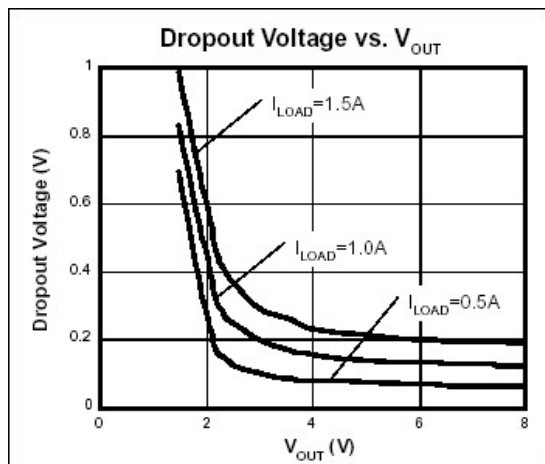
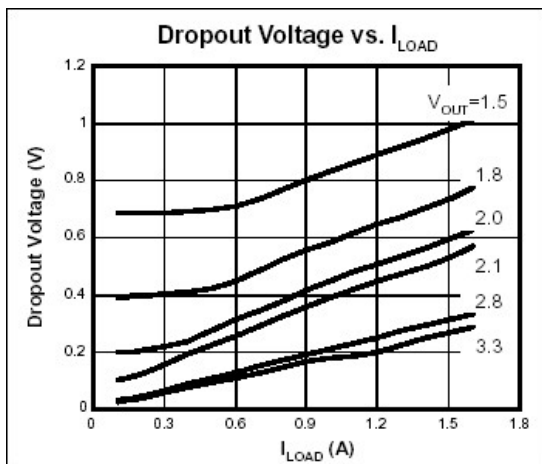
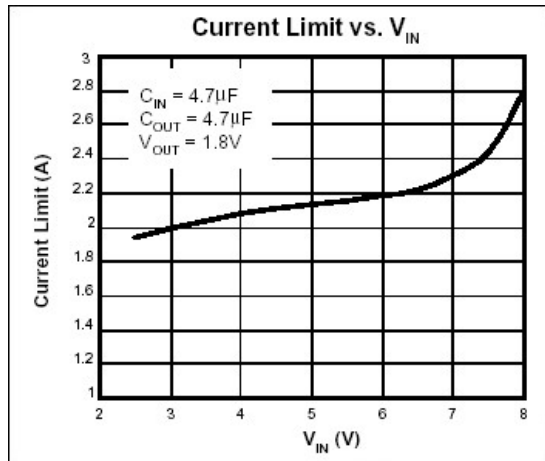
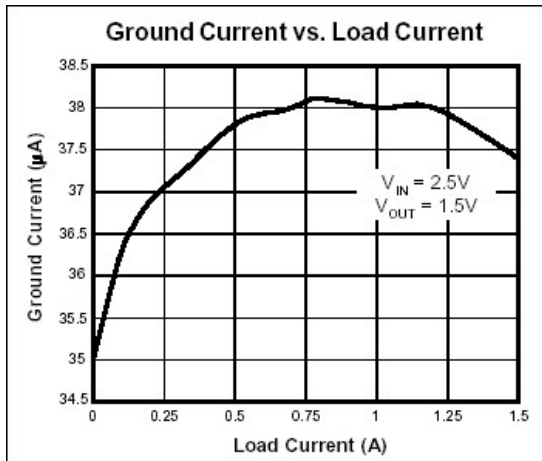
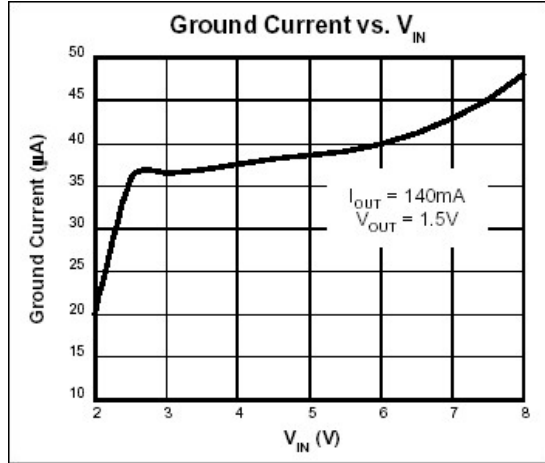
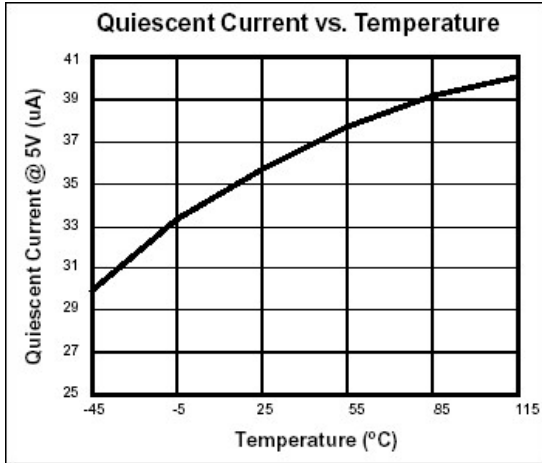

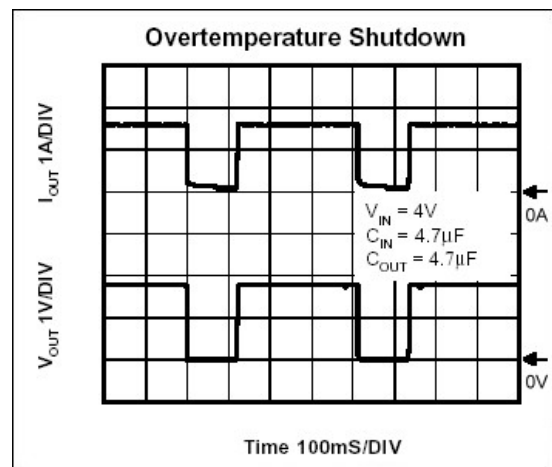
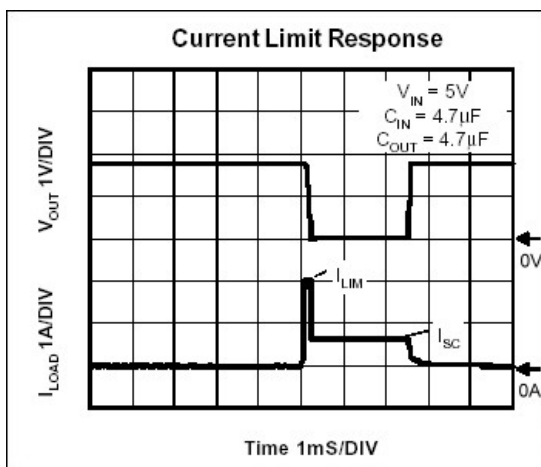
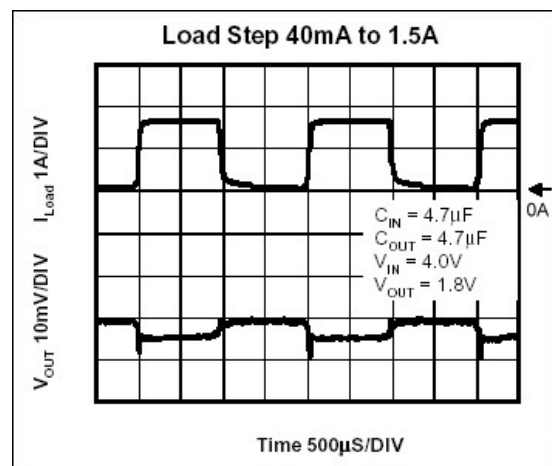
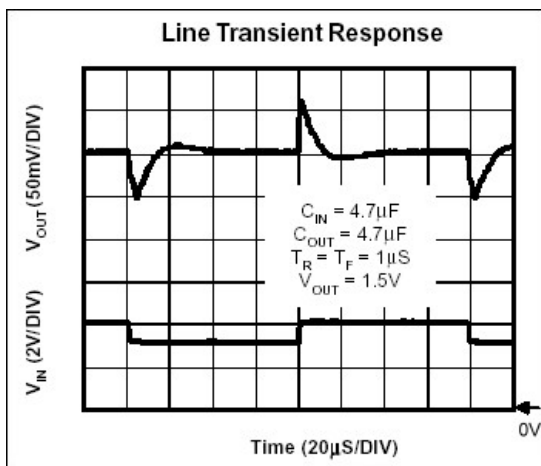
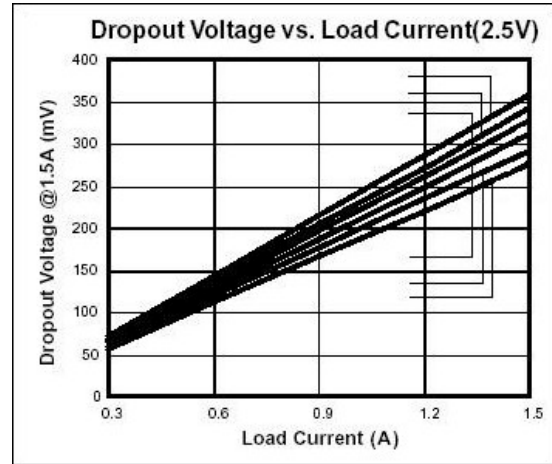
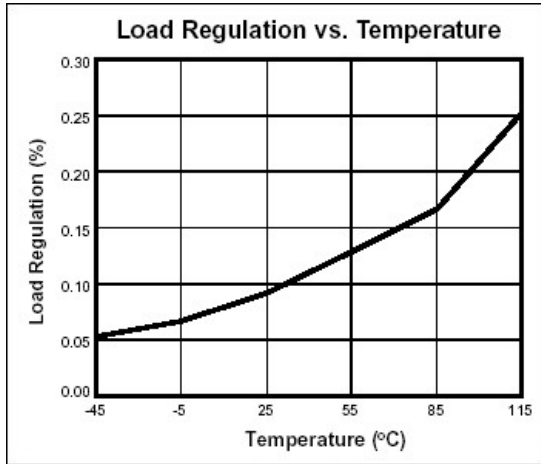

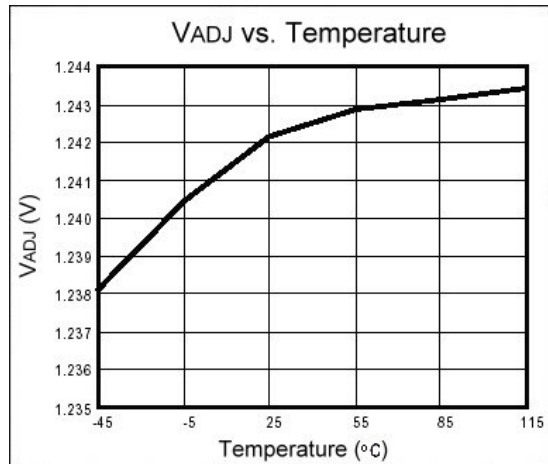
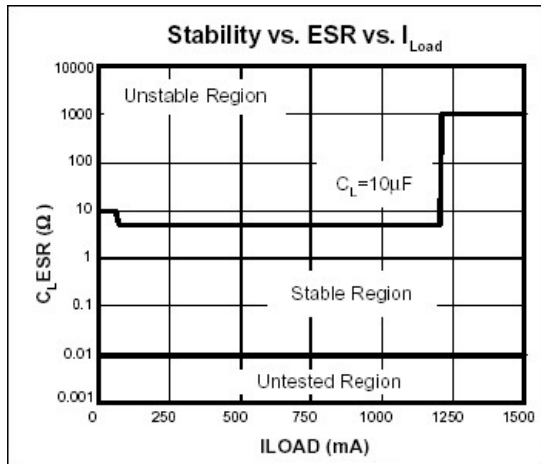
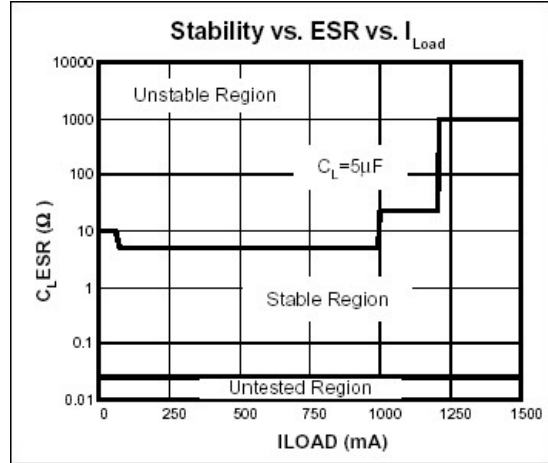
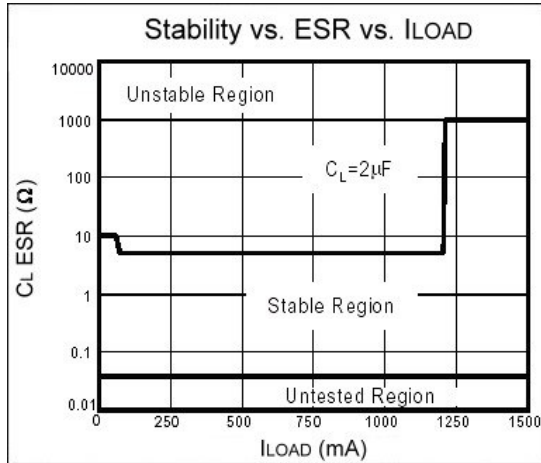



Elektronische Bauelemente

SSC2139

1.55A CMOS
Low Dropout Voltage Regulator

External Resistor Divider Table

R1(kΩ)	1	2	5	10	20	50
VOUT	$R2(k\Omega)=(1.242*R1(k\Omega))/(V_{out}-1.242)$					
1.30	21.41	42.83	107.07	214.14	428.28	1070.7
1.35	11.50	23.00	57.50	115.00	230.00	575.00
1.40	7.86	15.72	39.30	78.61	157.22	393.04
1.45	5.97	11.94	29.86	59.71	119.42	298.56
1.50	4.81	9.63	24.07	48.14	96.28	240.70
1.55	4.03	8.06	20.16	40.32	80.65	201.62
1.60	3.47	6.94	17.35	34.69	68.39	173.46
1.65	3.04	6.09	15.22	30.44	60.88	152.21
1.70	2.71	5.42	13.56	27.12	54.24	135.59
1.75	2.44	4.89	12.22	24.45	48.90	122.24
1.80	2.23	4.45	11.13	22.26	44.52	111.29
1.85	2.04	4.09	10.21	20.43	40.86	102.14
1.90	1.89	3.78	9.44	18.88	37.75	94.38
1.95	1.75	3.51	8.77	17.54	35.08	87.71
2.00	1.64	3.28	8.19	16.39	32.77	81.93
2.05	1.54	3.07	7.69	15.37	30.74	76.86
2.10	1.45	2.90	7.24	14.48	28.95	72.38
2.15	1.37	2.74	6.84	13.68	27.36	68.39
2.20	1.30	2.59	6.48	12.96	25.93	64.82
2.25	1.23	2.46	6.16	12.32	24.65	61.61
2.30	1.17	2.35	5.87	11.74	23.48	58.70
2.35	1.12	2.24	5.60	11.21	22.42	56.05
2.40	1.07	2.15	5.36	10.73	21.45	53.63
2.45	1.03	2.06	5.14	10.28	20.56	51.41
2.50	0.99	1.97	4.94	9.87	19.75	49.36
2.55	0.95	1.90	4.75	9.50	18.99	47.48
2.60	0.91	1.83	4.57	9.15	18.29	45.73
2.65	0.88	1.76	4.41	8.82	17.64	44.11
2.70	0.85	1.70	4.26	8.52	17.04	42.59
2.75	0.82	1.65	4.12	8.24	16.47	41.18
2.80	0.80	1.59	3.99	7.97	15.94	39.86
2.85	0.77	1.54	3.86	7.72	15.45	38.62
2.90	0.75	1.50	3.75	7.49	14.98	37.45
2.95	0.73	1.45	3.64	7.27	14.54	36.36
3.00	0.71	1.41	3.53	7.06	14.13	35.32
3.05	0.69	1.37	3.43	6.87	13.74	34.35
3.10	0.67	1.34	3.34	6.68	13.37	33.42
3.15	0.65	1.30	3.25	6.51	13.02	32.55

R1(kΩ)	1	2	5	10	20	50
VOUT	$R2(k\Omega)=(1.242*R1(k\Omega))/(V_{out}-1.242)$					
3.20	0.63	1.27	3.17	6.34	12.69	31.72
3.25	0.62	1.24	3.09	6.19	12.37	30.93
3.30	0.60	1.21	3.02	6.03	12.07	30.17
3.35	0.59	1.18	2.95	5.89	11.78	29.46
3.40	0.58	1.15	2.88	5.76	11.51	28.78
3.45	0.56	1.13	2.81	5.63	11.25	28.13
3.50	0.55	1.10	2.75	5.50	11.00	27.50
3.55	0.54	1.08	2.69	5.38	10.76	26.91
3.60	0.53	1.05	2.63	5.27	10.53	26.34
3.65	0.52	1.03	2.58	5.16	10.32	25.79
3.70	0.51	1.01	2.53	5.05	10.11	25.26
3.75	0.50	0.99	2.48	4.95	9.90	24.76
3.80	0.49	0.97	2.43	4.86	9.71	24.28
3.85	0.48	0.95	2.38	4.76	9.52	23.81
3.90	0.47	0.93	2.34	4.67	9.35	23.36
3.95	0.46	0.92	2.29	4.59	9.17	22.93
4.00	0.45	0.90	2.25	4.50	9.01	22.52
4.05	0.44	0.88	2.21	4.42	8.85	22.12
4.10	0.43	0.87	2.17	4.35	8.69	21.73
4.15	0.43	0.85	2.14	4.27	8.54	21.35
4.20	0.42	0.84	2.10	4.20	8.40	20.99
4.25	0.41	0.83	2.06	4.13	8.26	20.64
4.30	0.41	0.81	2.03	4.06	8.12	20.31
4.35	0.40	0.80	2.00	4.00	7.99	19.98
4.40	0.39	0.79	1.97	3.93	7.87	19.66
4.45	0.39	0.77	1.94	3.87	7.74	19.36
4.50	0.38	0.76	1.91	3.81	7.62	19.06
4.55	0.38	0.75	1.88	3.75	7.51	18.77
4.60	0.37	0.74	1.85	3.70	7.40	18.49
4.65	0.36	0.73	1.82	3.64	7.29	18.22
4.70	0.36	0.72	1.80	3.59	7.18	17.96
4.75	0.35	0.71	1.77	3.54	7.08	17.70
4.80	0.35	0.70	1.75	3.49	6.98	17.45
4.85	0.34	0.69	1.72	3.44	6.88	17.21
4.90	0.34	0.68	1.70	3.40	6.79	16.98
4.95	0.33	0.67	1.67	3.35	6.70	16.75
5.00	0.33	0.66	1.65	3.30	6.61	16.52

Note: Small load (greater than 2mA) is necessary as R1 or R2 is larger than 50kΩ. Otherwise, output voltage probably can not be pulled down to 0V on disable mode.