

## SPDT High Isolation Terminated Switch 0.01- 4.0 GHz

Rev. V2

### Features

- Positive Voltage Control
- High Isolation: 62 dB @ 1 GHz  
65 dB @ 2 GHz
- 50  $\Omega$  Internal Terminations
- Low Insertion Loss: 0.65 dB @ 1 GHz  
0.70 dB @ 2 GHz
- Fast Settling for Low Gate Lag requirements
- Lead-Free MSOP-8-EP Package
- Halogen-Free "Green" Mold Compound
- RoHS\* Compliant and 260°C Reflow Compatible

### Description

The MASW-008543 GaAs monolithic switch provides high isolation in a lead-free, plastic surface mount package. The MASW-008543 is ideal for applications across a broad range of frequencies.

M/A-COM Technology Solutions' fabricates the MASW-008543 using a 0.5-micron gate length pHEMT process. The process features full chip passivation for performance and reliability.

### Functional Block Diagram

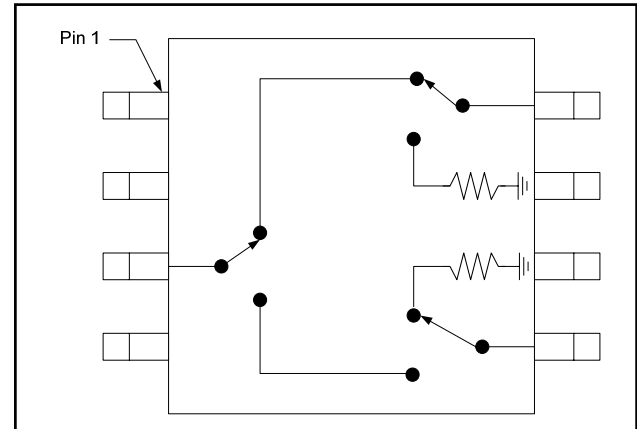

### Pin Configuration<sup>3</sup>

Pin	Function	Pin	Function
1	V1	5	RF Port 2
2	V2	6	Ground
3	RF Common	7	Ground
4	Ground	8	RF Port 1

3. The exposed pad centered on the package bottom must be connected to RF and DC ground.

### Ordering Information<sup>1,2</sup>

Part Number	Package
MASW-008543-000000	Bulk Packaging
MASW-008543-TR3000	3000 piece reel
MASW-008543-001SMB	Sample Board

1. Reference Application Note M513 for reel size information.
2. All sample boards include 5 loose parts.

### Absolute Maximum Ratings<sup>4,5</sup>

Parameter	Absolute Maximum
Input Power (0.5 - 3.0 GHz) $V_{HIGH} = 3.0 V$	33 dBm
Operating Voltage	8 V
Operating Temperature	-40°C to +85°C
Storage Temperature	-65°C to +150°C

4. Exceeding any one or combination of these limits may cause permanent damage to this device.
5. M/A-COM Technology Solutions does not recommend sustained operation near these survivability limits.

\* Restrictions on Hazardous Substances, European Union Directive 2002/95/EC.

## SPDT High Isolation Terminated Switch 0.01- 4.0 GHz

Rev. V2

**Electrical Specifications:**  $T_A = 25^\circ\text{C}$ ,  $V_{\text{HIGH}} = 3.0\text{ V}$ ,  $V_{\text{LOW}} = 0\text{ V}$ ,  $Z_0 = 50\ \Omega$ <sup>6</sup>

Parameter	Test Conditions	Units	Min.	Typ.	Max.
Insertion Loss	1.0 GHz	dB	—	0.65	—
	2.0 GHz	dB	—	0.70	0.95
	3.0 GHz	dB	—	0.85	—
	4.0 GHz	dB	—	1.10	—
Isolation	1.0 GHz	dB	—	62	—
	2.0 GHz	dB	62	65	—
	3.0 GHz	dB	—	50	—
	4.0 GHz	dB	—	45	—
Return Loss	0.5 - 4.0 GHz	dB	—	20	—
Input IP <sub>3</sub>	2-Tone, 2.1 GHz, 10 MHz spacing	dBm	—	53	—
P1dB	2.1 GHz	dBm	—	25	—
P0.1dB	2.1 GHz	dBm	—	20	—
Trise, Tfall	10% to 90% RF & 90% to 10% RF	ns	—	30	—
Ton, Toff	50% of V <sub>C</sub> to 10% / 90% RF	ns	—	52	—
Transients	In-band	mV	—	12	—
Control Current		μA	—	<1	5

6. External DC blocking capacitors are required on all RF ports (39 pF capacitors are recommended).

### Truth Table<sup>7,8,9</sup>

V1	V2	RFC-RF1	RFC-RF2
V <sub>HIGH</sub>	V <sub>LOW</sub>	On	Off
V <sub>LOW</sub>	V <sub>HIGH</sub>	Off	On

- $V_{\text{LOW}} = 0\text{ V} \pm 0.2\text{ V}$ ,  $V_{\text{HIGH}} = 1.8\text{ V}$  to  $+5\text{ V}$ , minimum  $V_{\text{HIGH}} - V_{\text{LOW}} = 1.8\text{ V}$ , maximum  $V_{\text{HIGH}} - V_{\text{LOW}} = 8.0\text{ V}$ .
- For use at low voltage, M/A-COM Technology Solutions recommends connecting a 20K pull up resistor on pin 3 to a voltage equal to the most positive control voltage.
- Negative control voltage may be used. The  $V_{\text{HIGH}}$  in the table would be the most positive (0 V) and the  $V_{\text{LOW}}$  would be the most negative (-3 V for example).

### Handling Procedures

Please observe the following precautions to avoid damage:

### Static Sensitivity

Gallium Arsenide Integrated Circuits are sensitive to electrostatic discharge (ESD) and can be damaged by static electricity. Proper ESD control techniques should be used when handling these devices.

### Lead-Free MSOP-8-EP†

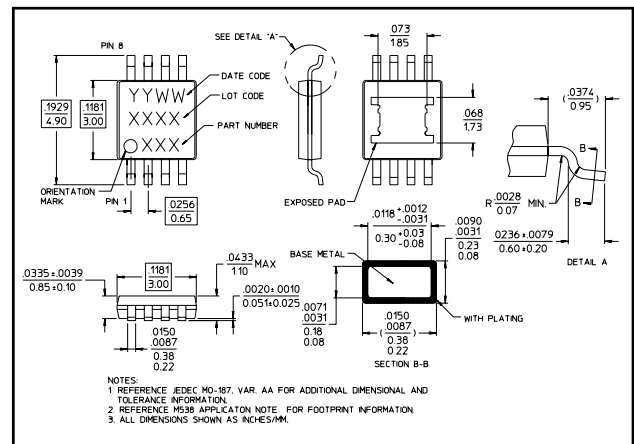

† Reference Application Note M538 for lead-free solder reflow recommendations

Meets JEDEC moisture sensitivity level 1 requirements. Plating is 100% matte tin over copper.

**ADVANCED:** Data Sheets contain information regarding a product M/A-COM Technology Solutions is considering for development. Performance is based on target specifications, simulated results, and/or prototype measurements. Commitment to develop is not guaranteed.  
**PRELIMINARY:** Data Sheets contain information regarding a product M/A-COM Technology Solutions has under development. Performance is based on engineering tests. Specifications are typical. Mechanical outline has been fixed. Engineering samples and/or test data may be available. Commitment to produce in volume is not guaranteed.

### Typical Performance Curves

**Insertion Loss**

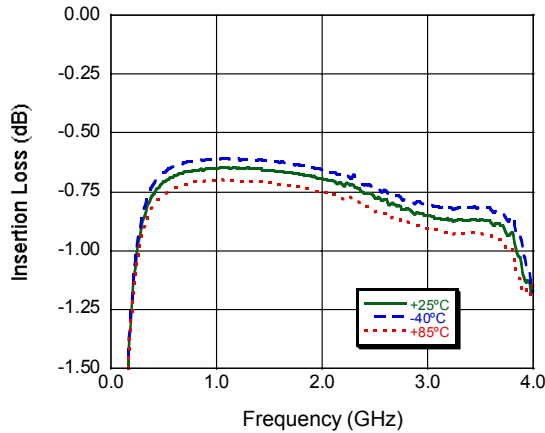

**Isolation**

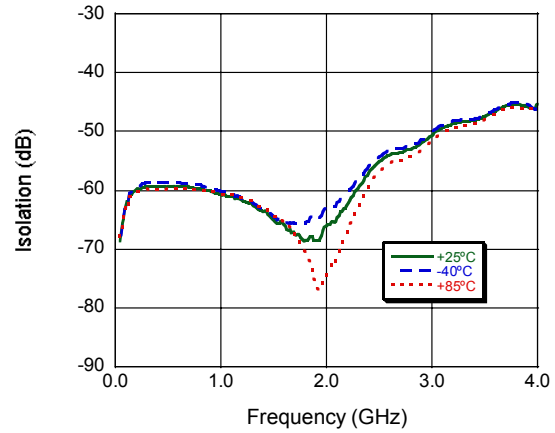

**Output Return Loss (on state)**

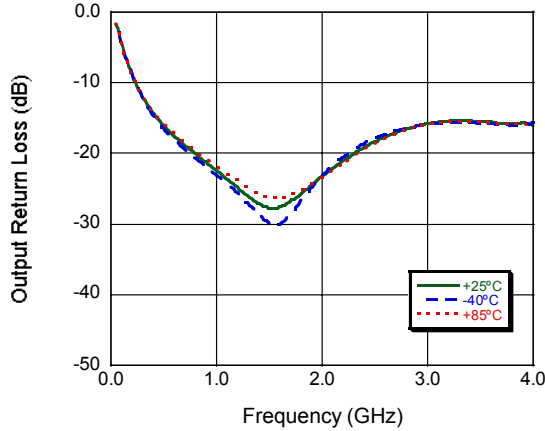

**Output Return Loss (off state)**

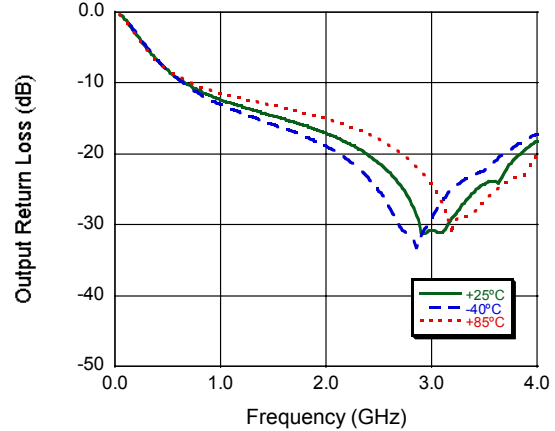

**Input Return Loss (on state)**

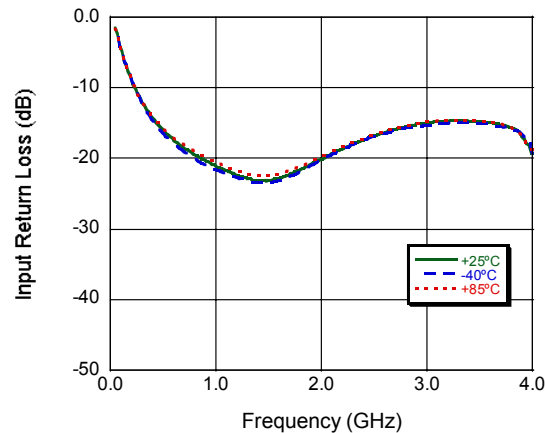

## Applications Section—Low Frequency Measurement

### Insertion Loss

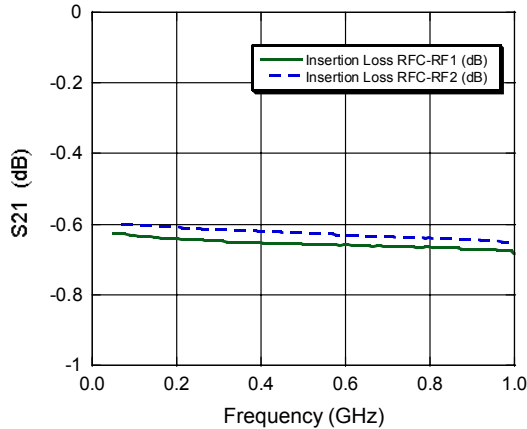

### Isolation

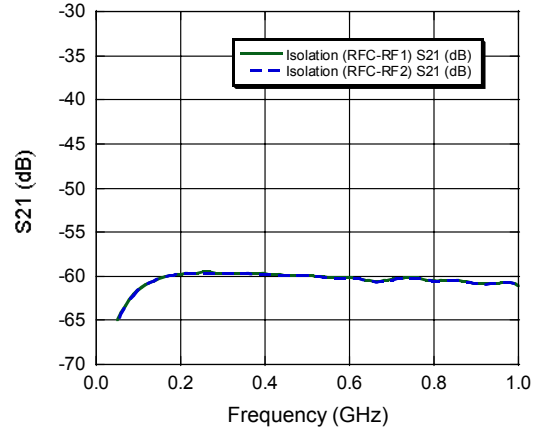

### Return Loss

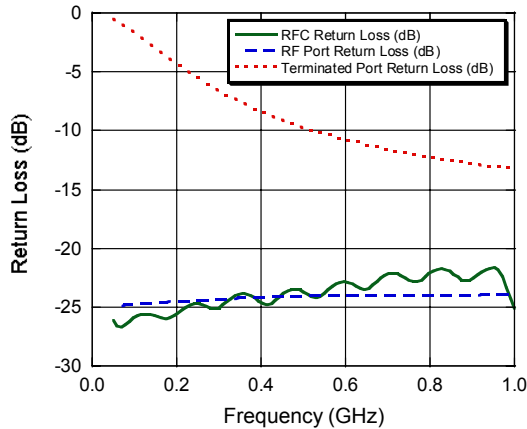

This data shows the MASW-008543 measured on an evaluation board with 0  $\Omega$  resistors. The board and connector loss have been removed.

0  $\Omega$  resistors can be used if negative control is available. To avoid changing the device bias points, the device should not be exposed to DC potentials on the RF ports.

With positive control M/A-COM Technology Solutions recommends using DC-Blocking capacitors large enough that their  $X_c$  is insignificant at the frequency of use. At 50 MHz a capacitor value greater than 1000 pF is recommended.