

E-Series Surface Mount Mixer 80 – 2500 MHz

MAMXES0117
V4

Features

- LO Power +17 dBm
- Up to +14 dBm RF
- Surface Mount
- RoHS* Compliant version of the ESMD-C50H
- Tape and reel packaging available

Description

M/A-COM's MAMXES0117 is a RoHS compliant device that is equivalent to the ESMD-C50H mixer. This device is a Low Cost, Passive Double Double Balanced Mixer. Constructed using very broad band ferrite balun transformers and matched silicon schottky diodes, it's performance is especially suited to high dynamic range receivers. Given it's high 1dB compression point, the MAMXES0117 is also suitable for Transmitter upconversion at any frequency up to 2.5GHz. The MAMXES0117 is offered in an SM-2 surface mount package and is designed to be utilized in both standard reflow and high temperature soldering reflow profiles.

SM — 2 Package

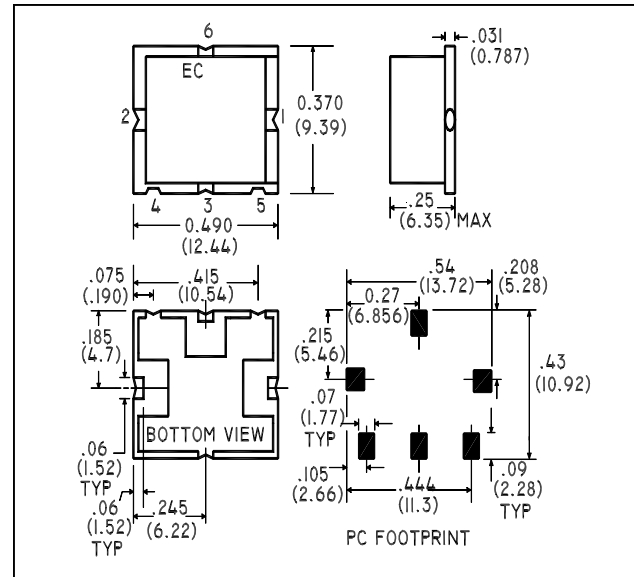

Electrical Specifications: $T_A = 25^\circ\text{C}$, $Z_0 = 50\Omega$ ¹

Parameter	Test Conditions	Frequency	Units	Min	Typ	Max
Frequency	IF 1.0 dB bandwidth = DC - 1000 MHz	80 -2500	MHz	—	—	—
Conversion Loss	—	80 - 1000	dB	—	6.1	7.5
		1000 - 2500	dB	—	7.34	9.0
Isolation	LO to RF	80 - 1000	dB	25	33.5	—
		1000 - 2500	dB	20	28.9	—
Isolation	LO to IF	80 - 1000	dB	26	31.5	—
		1000 - 2500	dB	13.5	17.4	—
Isolation	RF to IF	80 - 1000	dB	20	26.9	—
		1000 - 2500	dB	20	25.9	—
VSWR	LO	80 - 1000	—	—	1.42	2.0
		1000 - 2500	—	—	1.63	2.5
VSWR	RF	80 - 1000	—	—	1.72	2.8
		1000 - 2500	—	—	1.71	2.4

Ordering Information

Part Number	Package
MAMXES0117	Tape and Reel (500 piece reels)

* Restrictions on Hazardous Substances, European Union Directive 2002/95/EC.

E-Series Surface Mount Mixer
80 – 2500 MHz

MAMXES0117
V4

Electrical Specifications: $T_A = 25^\circ\text{C}$, $Z_0 = 50\Omega$ ¹

Parameter	Test Conditions	Frequency	Units	Min	Typ	Max
VSWR	IF	DC - 600	—	—	2.55	3.2
Input IP3	—	200 - 1000	dBm	21	27	—
		1000 - 2500	dBm	18	25	—
Input 1 dB Compression	—	80 -2500	dBm	—	14.0	—

Pin Configuration

Pin No.	Function
1	RF
2	LO
3	IF
4	Ground
5	Ground
6	Ground

Schematic

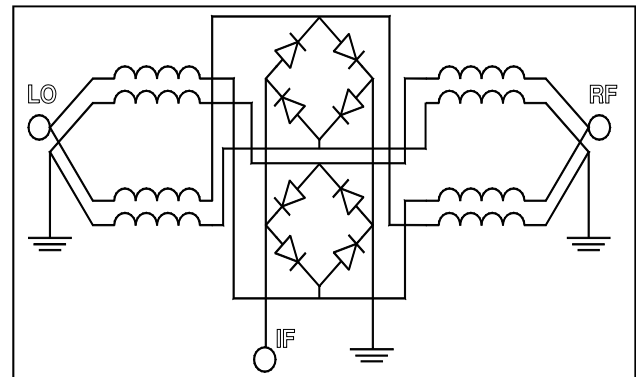

Absolute Maximum Ratings ¹

Parameter	Absolute Maximum
RF Input Power	+23 dBm
LO Drive Power	+23 dBm
Operating Temperature	-40°C to +85°C
Storage Temperature	-55°C to +125°C

1. Operation of this device above any one of these parameters may cause permanent damage.

E-Series Surface Mount Mixer
80 – 2500 MHz

MAMXES0117
V4

Typical Performance Curves

Conversion Loss

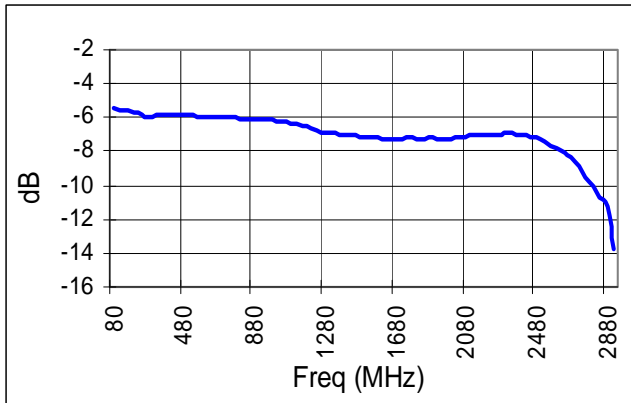

Isolation

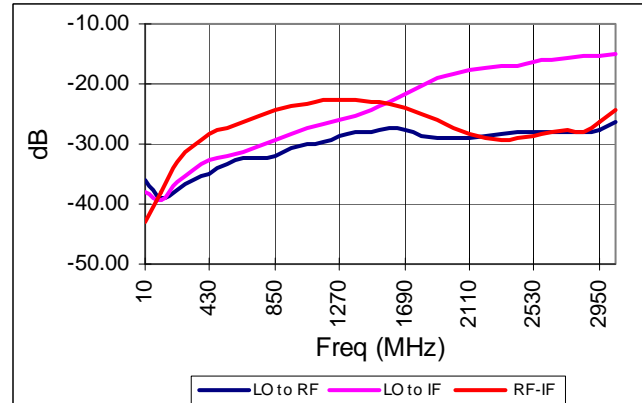

LO & RF VSWR

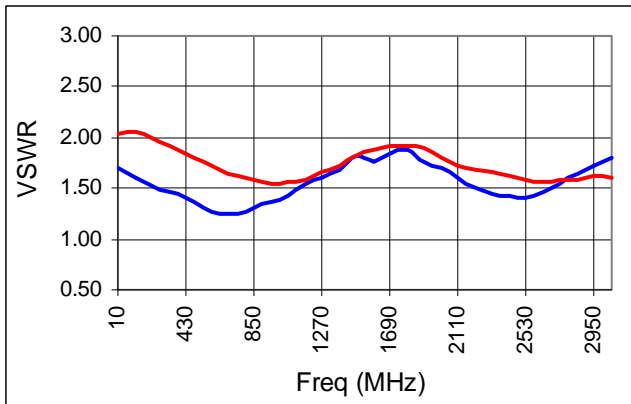

IF VSWR

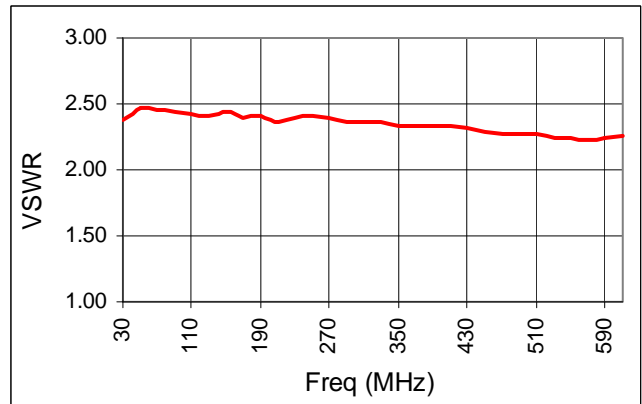

IF Bandwidth

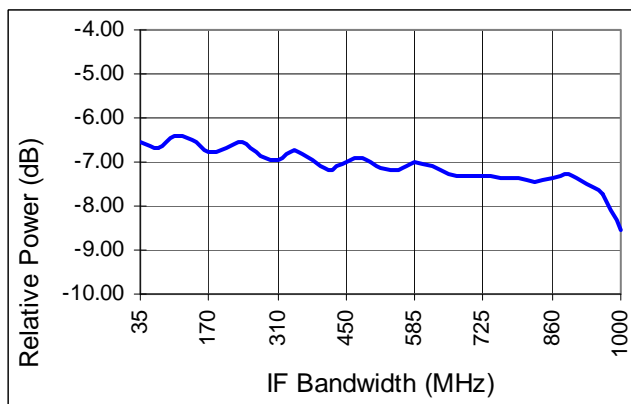

IIP3 & 1 dB Compression

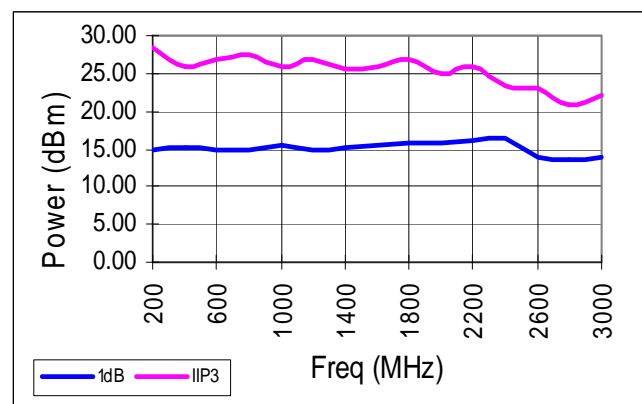

ADVANCED: Data Sheets contain information regarding a product M/A-COM Technology Solutions is considering for development. Performance is based on target specifications, simulated results, and/or prototype measurements. Commitment to develop is not guaranteed.
PRELIMINARY: Data Sheets contain information regarding a product M/A-COM Technology Solutions has under development. Performance is based on engineering tests. Specifications are typical. Mechanical outline has been fixed. Engineering samples and/or test data may be available. Commitment to produce in volume is not guaranteed.

• **North America** Tel: 800.366.2266 • **Europe** Tel: +353.21.244.6400
 • **India** Tel: +91.80.4155721 • **China** Tel: +86.21.2407.1588
 Visit www.macomtech.com for additional data sheets and product information.

M/A-COM Technology Solutions Inc. and its affiliates reserve the right to make changes to the product(s) or information contained herein without notice.

E-Series Surface Mount Mixer
80 – 2500 MHz

MAMXES0117
V4

Spurious Table: 1800MHz

(In dBc below IF, assuming down conversion)

		nf _{LO} - mf _{RF}					
RF	0	X	-6	12	21	13	
	1	29	0	35	18	42	
	2	64	58	58	51	72	
	(n)	3	76	80	78	76	73
		4	83	85	85	82	85.34
		0	1	2	3	4	
LO (m)							

RF = 1842.50 MHz, -5dBm
LO = 1772.50 MHz, +17dBm
IF = 70 MHz

(In dBc below IF, assuming down conversion)

		nf _{LO} - mf _{RF}					
RF	0	X	2	14	12	29	
	1	20	0	37	12	39	
	2	25	26	38	27	32	
	(n)	3	46	41	44	43	44
		4	57	56	54	55	57
		0	1	2	3	4	
LO (m)							

RF = 970 MHz, -5dBm
LO = 900 MHz, +17dBm
IF = 70 MHz

Spurious Table: 1900MHz

(In dBc below IF, assuming down conversion)

		nf _{LO} - mf _{RF}					
RF	0	X	-8	21	16	19	
	1	24	0	39	17	50	
	2	29	32	29	22	31	
	(n)	3	51	46	51	41	50
		4	52	55	55	52	55
		0	1	2	3	4	
LO (m)							

RF = 1960 MHz, -5dBm
LO = 1890 MHz, +17dBm
IF = 70 MHz