

PLEASE CHECK WWW.MOLEX.COM FOR LATEST PART INFORMATION

Part Number: [0885273503](#)
Status: **Active**
Overview: [fiber optic product families](#)
Description: FC-to-ST, Multimode, 62.5/125µm, Duplex, 3.00mm (.118"), Standard Fiber Optic Cable Assembly, 5.0m (16.40')

Documents:

[Drawing \(PDF\)](#) [RoHS Certificate of Compliance \(PDF\)](#)

General

Product Family	Fiber Optic Assemblies
Series	88527
Connector to Connector	FC-to-ST
Mode	Multimode
Overview	fiber optic product families
Product Name	FC, ST

Physical

Cable Length	5.0m (16.40')
Cable Size	3.00mm (.118")
Fiber (Core/Cladding)	62.5/125µm
Single Ended	No
Wire/Cable Type	Duplex

Material Info

Reference - Drawing Numbers

Sales Drawing	SD-88527-022
---------------	--------------

EU RoHS

RoHS Compliant by Exemption
REACH SVHC
Not Reviewed
Halogen-Free Status
Not Reviewed

China RoHS



Need more information on product environmental compliance?

Email productcompliance@molex.com
 For a multiple part number RoHS Certificate of Compliance, [click here](#)

Please visit the [Contact Us](#) section for any non-product compliance questions.

Search Parts in this Series
[88527Series](#)

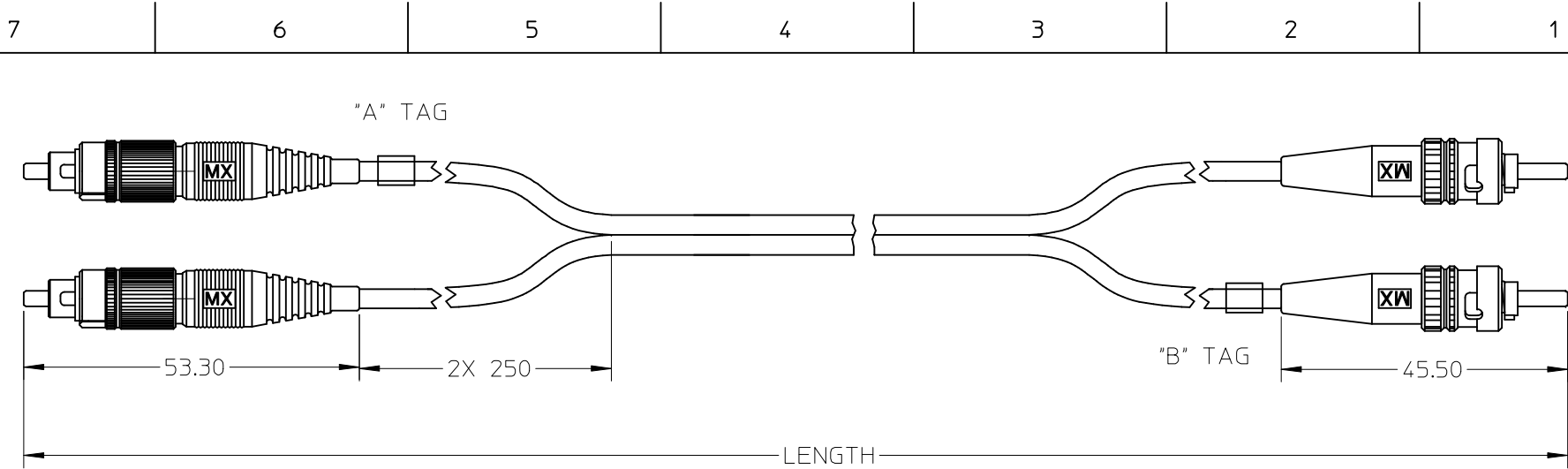

885273504	FC-ST DUP MM 62.5/125 3MM 10M	10000(+200/-0)
885273503	FC-ST DUP MM 62.5/125 3MM 5M	5000(+200/-0)
885273502	FC-ST DUP MM 62.5/125 3MM 3M	3000(+200/-0)
885273501	FC-ST DUP MM 62.5/125 3MM 2M	2000(+200/-0)
885273500	FC-ST DUP MM 62.5/125 3MM 1M	1000(+100/-0)
MX P/N	DESCRIPTION	LENGTH

NOTES:
 1. DUST CAPS ARE NOT SHOWN
 2. PER CHANNEL @ 850nm
 IL <= 0.50dB

ENTER DESCRIPTION EC NO: DG2009-0079 DRWN: XPCHEN CHKD: APPR: JOWANG	2008/11/10	2008/11/10	2008/11/12
	DESCRIPTION	REV	REV

QUALITY SYMBOLS GENERAL TOLERANCES (UNLESS SPECIFIED)			
		mm	INCH
	4 PLACES	± ---	± ---
	3 PLACES	± ---	± ---
	2 PLACES	± ---	± ---
	1 PLACE	± ---	± ---
	ANGULAR ± ---°		
DRAFT WHERE APPLICABLE MUST REMAIN WITHIN DIMENSIONS			

DIMENSION STYLE MM ONLY	
DRAWN BY XP	DATE 2008/10/07
CHECKED BY LISA	DATE 2008/10/07
APPROVED BY JOHNNY	DATE 2008/10/07
MATERIAL NO.	DOCUMENT NO.

SCALE ---	DESIGN UNITS METRIC	THIRD ANGLE PROJECTION
TITLE FC-ST DUP MM 62.5 3MM		
MOLEX INCORPORATED		SHEET NO. 1 OF 00
ENTER PART		SD-88527-022
THIS DRAWING CONTAINS INFORMATION THAT IS PROPRIETARY TO MOLEX INCORPORATED AND SHOULD NOT BE USED WITHOUT WRITTEN PERMISSION		