

PLEASE CHECK WWW.MOLEX.COM FOR LATEST PART INFORMATION

Part Number: [0675031340](#)
Status: **Active**
Overview: [usb_otg_onthego](#)
Description: 0.80mm (.031") Pitch, USB On-The-Go (OTG) Mini-B Receptacle, Through Hole, Right Angle, Straight Solder Tabs, with PCB Locator Plastic Pegs, Lead Free

Documents:

[3D Model](#) [Product Specification PS-67803-001 \(PDF\)](#)
[Drawing \(PDF\)](#) [RoHS Certificate of Compliance \(PDF\)](#)

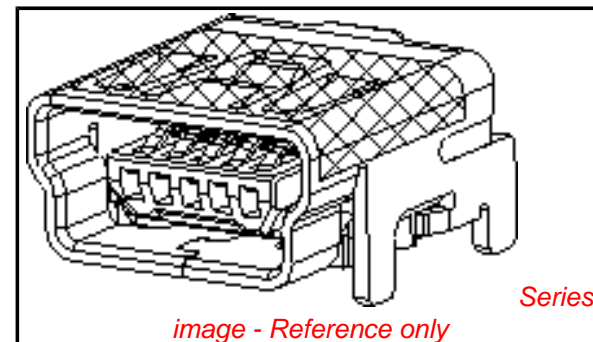

General

Product Family	I/O Connectors
Series	67503
Application	Wire-to-Board
Component Type	Receptacle
Overview	usb_otg_onthego
Product Name	USB OTG (On-The-Go)
Type	Mini-B

Physical

Boot Color	N/A
Circuits (Loaded)	5
Circuits (maximum)	5
Color - Resin	Black
Gender	Receptacle
Lock to Mating Part	Yes
Material - Metal	Copper Alloy
Material - Plating Mating	Gold
Material - Plating Termination	Tin
Material - Resin	Nylon
Number of Rows	1
Orientation	Right Angle
PCB Locator	Yes
PCB Retention	Yes
PCB Thickness Recommended (in)	0.039 In
PCB Thickness Recommended (mm)	1.00 mm
Packaging Type	Embossed Tape on Reel
Panel Mount	No
Pitch - Mating Interface (in)	0.031 In
Pitch - Mating Interface (mm)	0.80 mm
Pitch - Term. Interface (in)	0.031 In
Pitch - Term. Interface (mm)	0.80 mm
Plating min: Mating (µin)	30
Plating min: Mating (µm)	0.76
Plating min: Termination (µin)	150
Plating min: Termination (µm)	3.80
Polarized to Mating Part	Yes
Polarized to PCB	Yes
Ports	1
Temperature Range - Operating	0°C to +50°C
Termination Interface: Style	Through Hole
Waterproof / Dustproof	No
Wire Size AWG	N/A

Electrical

Current - Maximum per Contact	1A
-------------------------------	----

EU RoHS

**ELV and RoHS
Compliant**

REACH SVHC

Not Reviewed

Halogen-Free

Status

Not Reviewed

**Need more information on product
environmental compliance?**

Email productcompliance@molex.com
For a multiple part number RoHS Certificate of
Compliance, [click here](#)

Please visit the [Contact Us](#) section for any
non-product compliance questions.

China RoHS



Search Parts in this Series

[67503Series](#)

Mates With

[47014 USB Mini-B Plug Kit](#)

Shield Type	Full Shield
Shielded	Yes
Voltage - Maximum	30V AC (RMS)/DC

Material Info

Reference - Drawing Numbers

Packaging Specification	PK-67503-001
Product Specification	PS-67803-001
Sales Drawing	SD-67503-013

This document was generated on 05/19/2010

PLEASE CHECK WWW.MOLEX.COM FOR LATEST PART INFORMATION

NOTES :

1.MATERIAL :

HOUSING : NYLON, GLASS FILLER, BLACK, UL94V-0.
 TERMINAL : COPPER ALLOY, THICKNESS=0.2mm.
 SHIELD CASE : COPPER ALLOY, THICKNESS=0.4mm.

2.PLATING :

TERMINAL :
 CONTACT AREA : GOLD, 0.75 MICROMETER MINIMUM.
 SOLDER AREA : PURE TIN, 3.8 MICROMETER MINIMUM.
 UNDER PLATING : NICKEL, 1.25 MICROMETER MINIMUM.
 SHIELD CASE :
 PURE TIN(Sn): 1-3 MICROMETER.
 UNDER PLATING : NICKEL, 1.0 MICROMETER MINIMUM.

3.TAIL COPLANARITY TO BE 0.1mm MAXIMUM.

4.PRODUCT SPECIFICATION REFER TO PS-67803-001.

5.PACKAGING INFORMATION REFER TO PK-67503-001.

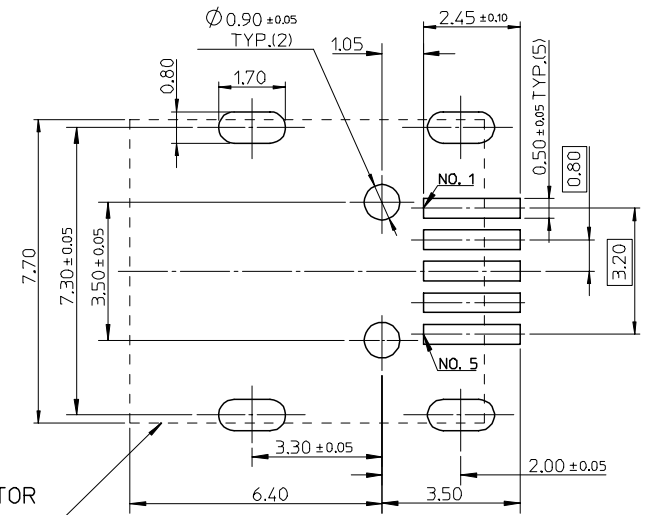
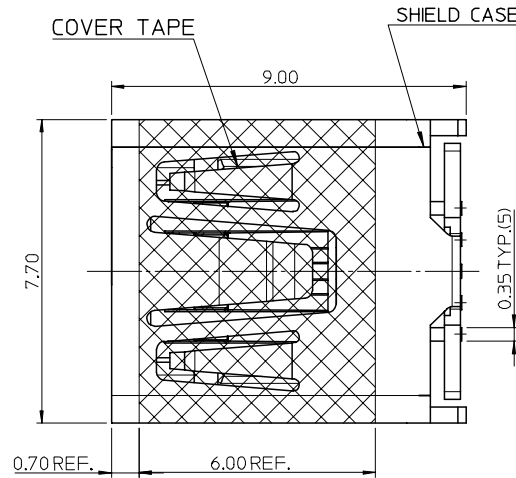

RECOMMENDED P.C.B. LAYOUT
 (THICKNESS = 1.0mm)

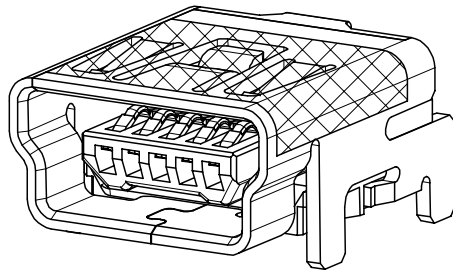
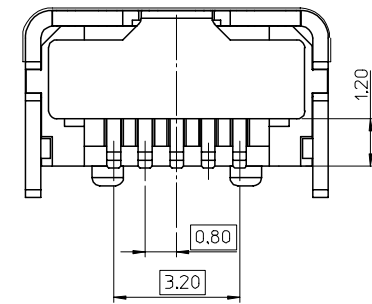
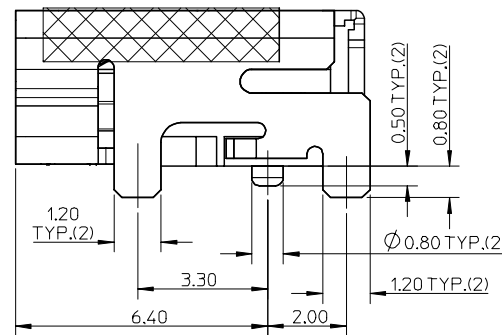
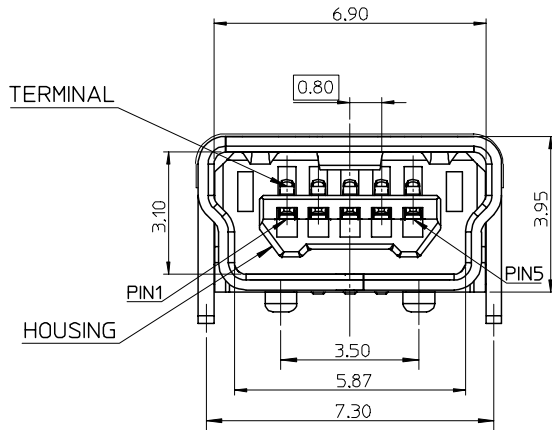

REVISE EC NO: SH2007-0150 DRWN: XJ SONG 2006/09/06 CHKD: WANG 2006/09/07 APPR: JINCHEN 2006/09/18	QUALITY SYMBOLS	GENERAL TOLERANCES (UNLESS SPECIFIED)	SCALE 8:1	DESIGN UNITS METRIC	THIRD ANGLE PROJECTION	REVISE ON CAD ONLY	
	▴ - 0 ▽ - 0 S - 0	mm INCH 4 PLACES ± --- ± --- 3 PLACES ± --- ± --- 2 PLACES ± 0.25 ± --- 1 PLACE ± 0.25 ± --- ANGULAR ± 3 °	DIMENSION STYLE MM ONLY	TITLE	USB SERIES MINI-B REC. ASS'Y FOR SMT TYPE III(LEAD FREE)		
	DRAFT WHERE APPLICABLE	MUST REMAIN WITHIN DIMENSIONS	APPROVED BY ELAN	DATE '01/10/25	MOLEX INCORPORATED MATERIAL NO. 67503-1340 DOCUMENT NO. SD-67503-013 SHEET NO. 1 OF 1		
			THIS DRAWING CONTAINS INFORMATION THAT IS PROPRIETARY TO MOLEX INCORPORATED AND SHOULD NOT BE USED WITHOUT WRITTEN PERMISSION				