

**PLEASE CHECK WWW.MOLEX.COM FOR LATEST PART INFORMATION**

**Part Number:** [0432236152](#)  
**Status:** **Active**  
**Overview:** [modular\\_plugs\\_jacks](#)  
**Description:** Modular Jack, Right Angle, Low Profile, 6/2, 5 Ports

**Documents:**

[3D Model](#) [Product Specification PS-43223-001 \(PDF\)](#)  
[Drawing \(PDF\)](#) [RoHS Certificate of Compliance \(PDF\)](#)

**Agency Certification**

CSA LR19980  
 UL E107635

**General**

Product Family Modular Jacks/Plugs  
 Series [43223](#)  
 Component Type PCB Jack  
 Magnetic No  
 Overview [modular\\_plugs\\_jacks](#)  
 Performance Category 3  
 Power over Ethernet (PoE) N/A  
 Product Name RJ11

**Physical**

Boot Color N/A  
 Color - Resin Black  
 Durability (mating cycles max) 500  
 Flammability 94V-0  
 Inverted / Top Latch No  
 Keying to Mating Part None  
 Lightpipes/LEDs None  
 Material - Metal Phosphor Bronze  
 Material - Plating Mating Gold  
 Material - Plating Termination Tin  
 Material - Resin High Temperature Thermoplastic  
 Orientation Right Angle (Side Entry)  
 PCB Locator Yes  
 PCB Retention Yes  
 PCB Thickness Recommended (in) 0.062 In  
 PCB Thickness Recommended (mm) 1.57 mm  
 Packaging Type Tray  
 Panel Mount Without Flange  
 Pitch - Mating Interface (in) 0.040 In  
 Pitch - Mating Interface (mm) 1.02 mm  
 Pitch - Term. Interface (in) 0.050 In  
 Pitch - Term. Interface (mm) 1.27 mm  
 Plating min: Mating (µin) 50  
 Plating min: Mating (µm) 1.25  
 Plating min: Termination (µin) 100  
 Plating min: Termination (µm) 2.5  
 Ports 5  
 Positions / Loaded Contacts 6/2  
 Surface Mount Compatible (SMC) No  
 Temperature Range - Operating -40°C to +85°C  
 Termination Interface: Style Through Hole  
 Waterproof / Dustproof No

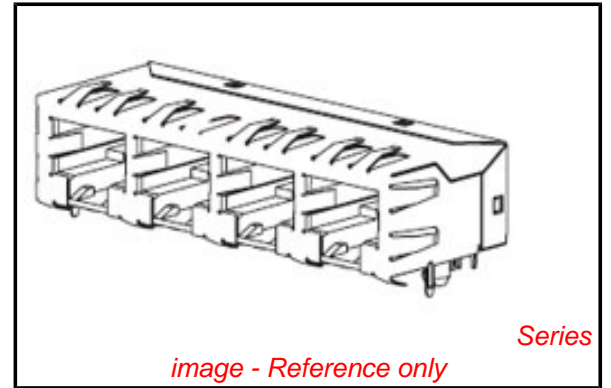

**EU RoHS**

**ELV and RoHS  
 Compliant**  
**REACH SVHC**  
 Not Reviewed  
**Halogen-Free  
 Status**  
**Not Reviewed**

**China RoHS**



**Need more information on product  
 environmental compliance?**

Email [productcompliance@molex.com](mailto:productcompliance@molex.com)  
 For a multiple part number RoHS Certificate of  
 Compliance, [click here](#)

Please visit the [Contact Us](#) section for any  
 non-product compliance questions.

**Search Parts in this Series**

[43223Series](#)

**Mates With**

FCC 68 Plugs

Wire/Cable Type	N/A
<b>Electrical</b>	
Current - Maximum per Contact	1.5A
Grounding to PCB	Yes
Grounding to Panel	None
Shielded	No
Voltage - Maximum	150V AC (RMS)

**Solder Process Data**

Lead-free Process Capability	Wave Capable (TH only)
------------------------------	------------------------

**Material Info**

Old Part Number	A432236152
-----------------	------------

**Reference - Drawing Numbers**

Packaging Specification	PK-43249-004
Product Specification	PS-43223-001
Sales Drawing	SDA-43223
Test Summary	TS-43223-001

This document was generated on 06/07/2010

**PLEASE CHECK [WWW.MOLEX.COM](http://WWW.MOLEX.COM) FOR LATEST PART INFORMATION**

NOTES:

- MATERIAL:  
HOUSING: GLASS FILLED NYLON, UL94V-0, COLOR: BLACK  
INSULATOR: GLASS FILLED NYLON, UL94V-0, COLOR: BLACK  
TERMINALS: PHOSPHOR BRONZE: .012/ 0.30 THICK
- FINISH:  
TERMINALS:  
SELECT GOLD IN CONTACT AREA: 50 MICRONS/ 1.27 MICROMETERS MIN.,  
\*SELECT TIN IN PC TAIL AREA: 100 MICRONS/ 2.54 MICROMETERS MIN.,  
WITH OVERALL NICKEL UNDERPLATE: 50 MICRONS/ 1.27 MICROMETERS MIN.  
\*THE PRIMARY SHIPPING CARTON WILL BE LABELED "COMPLIANT TO RoHS DIRECTIVE 2002/95/EC AND ELV ANNEX II OF DIRECTIVE 2000/53/EC".  
CARTONS WITHOUT THIS LABEL MAY CONTAIN PRODUCT WITH TIN-LEAD IN THE PC TAIL AREA.
- PRODUCT SPECIFICATION AND PROCESSING PARAMETERS: PS-43223-001.
- PACKAGING SPECIFICATION:  
UNSHIELDED CONNECTOR ASSEMBLIES PACKAGED IN TRAYS PER MOLEX PACKAGING SPECIFICATION PK-43249-004.
- SEE SHEETS 4-6 FOR P.C. BOARD LAYOUTS.
- SEE SHEET 2 FOR THE SHIELDED JACK ASSEMBLY.
- FOR 6 CIRCUIT JACKS CENTERLINE TO CENTERLINE SPACING IS .448/ 11.38, FOR 8 CIRCUIT JACKS CENTERLINE TO CENTERLINE SPACING IS .550/ 13.97.
- ALL UNTOLERANCED DIMENSIONS ARE SHOWN FOR REFERENCE ONLY.
- THIS PART CONFORMS TO CLASS B REQUIREMENTS OF COSMETIC SPECIFICATION PS-45499-002.

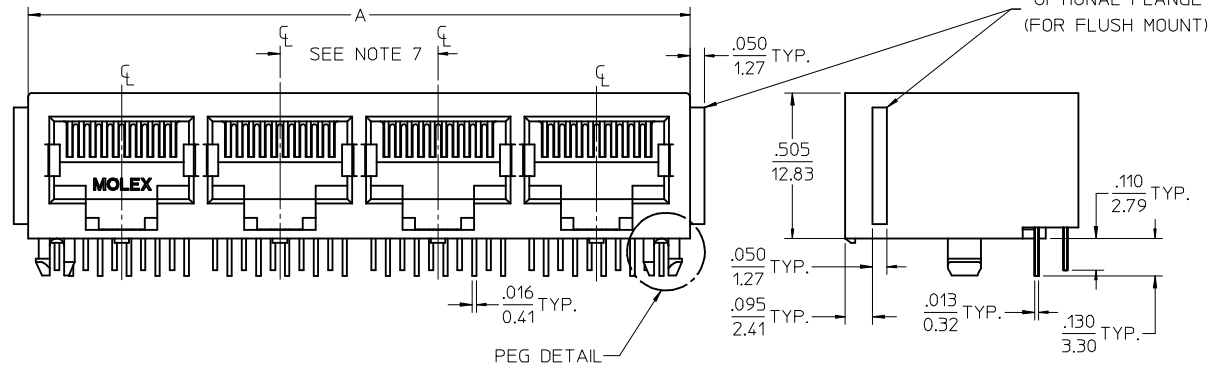

4 PORT 8 LOADED  
10 JACK SHOWN

UNSHIELDED GANGED JACK ASSEMBLY  
SEE SHEET 3

CENTER PEG  
(8 PORT ASSY. ONLY)

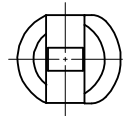
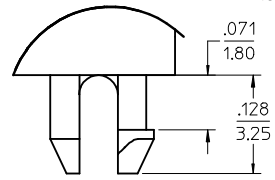

SNAP-FIT PEG DETAIL  
SCALE 8:1

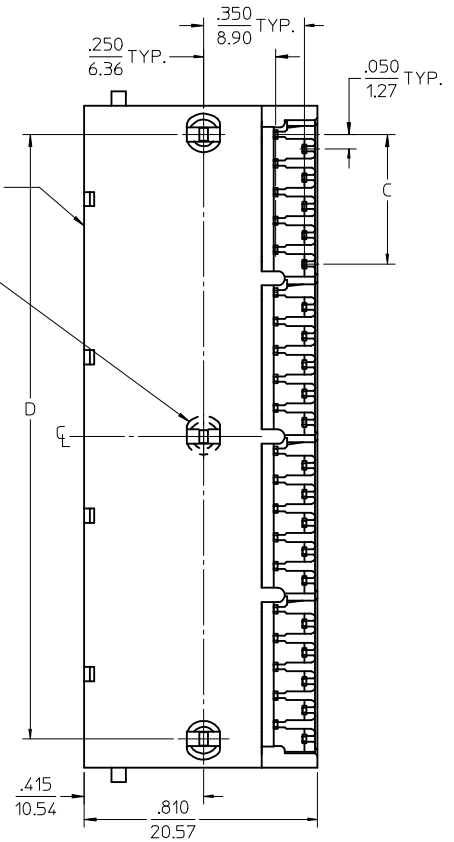

6 CIRCUIT HOUSING

CIRCUIT SIZE	NO. OF PORTS	DIM. A	DIM. C	DIM. D
6	2	.985 (25.02)	.250 (6.35)	.848 (21.54)
4	2	.985 (25.02)	.150 (3.81)	.848 (21.54)
2	2	.985 (25.02)	.050 (1.27)	.848 (21.54)
6	3	1.433 (36.40)	.250 (6.35)	1.296 (32.92)
4	3	1.433 (36.40)	.150 (3.81)	1.296 (32.92)
2	3	1.433 (36.40)	.050 (1.27)	1.296 (32.92)
6	4	1.881 (47.78)	.250 (6.35)	1.744 (44.30)
4	4	1.881 (47.78)	.150 (3.81)	1.744 (44.30)
2	4	1.881 (47.78)	.050 (1.27)	1.744 (44.30)
6	5	2.329 (59.16)	.250 (6.35)	2.192 (55.68)
4	5	2.329 (59.16)	.150 (3.81)	2.192 (55.68)
2	5	2.329 (59.16)	.050 (1.27)	2.192 (55.68)
6	6	2.777 (70.54)	.250 (6.35)	2.640 (67.06)
4	6	2.777 (70.54)	.150 (3.81)	2.640 (67.06)
2	6	2.777 (70.54)	.050 (1.27)	2.640 (67.06)
6	8	3.673 (93.29)	.250 (6.35)	3.536 (89.81)
4	8	3.673 (93.29)	.150 (3.81)	3.536 (89.81)
2	8	3.673 (93.29)	.050 (1.27)	3.536 (89.81)

8 CIRCUIT HOUSING

CIRCUIT SIZE	NO. OF PORTS	DIM. A	DIM. C	DIM. D
10	2	1.200 (30.48)	.450 (11.43)	1.000 (25.40)
8	2	1.200 (30.48)	.350 (8.89)	1.000 (25.40)
6	2	1.200 (30.48)	.250 (6.35)	1.000 (25.40)
10	3	1.750 (44.45)	.450 (11.43)	1.550 (39.37)
8	3	1.750 (44.45)	.350 (8.89)	1.550 (39.37)
6	3	1.750 (44.45)	.250 (6.35)	1.550 (39.37)
4	3	1.750 (44.45)	.150 (3.81)	1.550 (39.37)
10	4	2.300 (58.42)	.450 (11.43)	2.100 (53.34)
8	4	2.300 (58.42)	.350 (8.89)	2.100 (53.34)
4	4	2.300 (58.42)	.150 (3.81)	2.100 (53.34)
4	5	2.850 (72.39)	.450 (11.43)	2.650 (67.31)
10	5	2.850 (72.39)	.350 (8.89)	2.650 (67.31)
8	5	2.850 (72.39)	.250 (6.35)	2.650 (67.31)
10	6	3.400 (86.36)	.450 (11.43)	3.200 (81.28)
8	6	3.400 (86.36)	.350 (8.89)	3.200 (81.28)
10	8	4.500 (114.30)	.450 (11.43)	4.300 (109.22)
8	8	4.500 (114.30)	.350 (8.89)	4.300 (109.22)

ADD BLOCK TOL  
EC NO: UCP2009-0477  
DRWN: BELL 2008/09/05  
CHKD: BELL 2008/09/11  
APPR: FSMITH 2008/09/11

DESCRIPTION  
K1

REV

QUALITY SYMBOLS

GENERAL TOLERANCES (UNLESS SPECIFIED)

	mm	INCH
4 PLACES	± .010	± .0004
3 PLACES	± .015	± .0006
2 PLACES	± 0.38	± .015
1 PLACE	± .005	± .0002

ANGULAR ±1/2°

DRAFT WHERE APPLICABLE  
MUST REMAIN WITHIN DIMENSIONS

DIMENSION STYLE  
IN/MM

SCALE  
3:1

DESIGN UNITS  
INCH

THIRD ANGLE PROJECTION

DRAWN BY  
JTR

DATE  
1993/10/18

CHECKED BY  
JTR

DATE  
1993/10/18

APPROVED BY  
RAS

DATE  
1993/10/18

MATERIAL NO.  
SEE SHTS 3

DOCUMENT NO.  
SDA-43223

LOW PROFILE GANGED,  
RIGHT ANGLE MODULAR JACK  
ASSEMBLY

MOLEX INCORPORATED

SHEET NO.  
1 OF 6

THIS DRAWING CONTAINS INFORMATION THAT IS PROPRIETARY TO MOLEX INCORPORATED AND SHOULD NOT BE USED WITHOUT WRITTEN PERMISSION

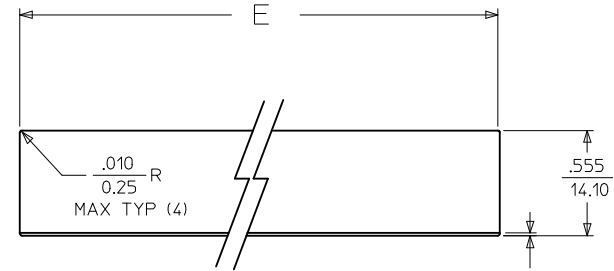
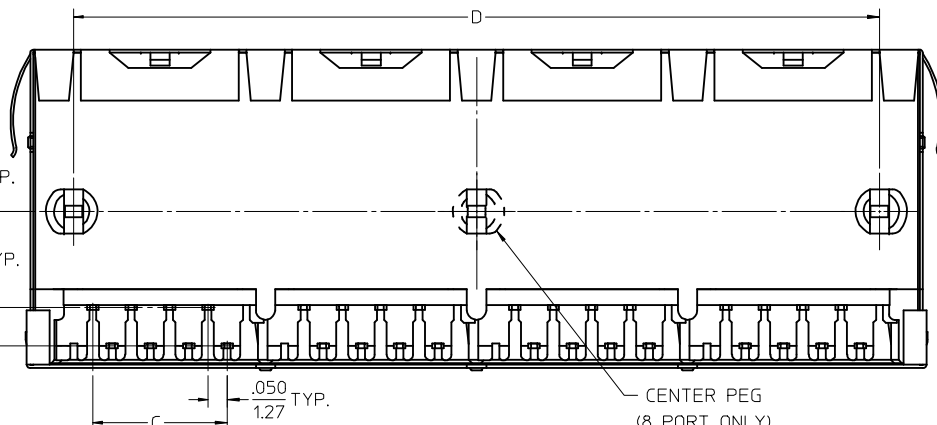
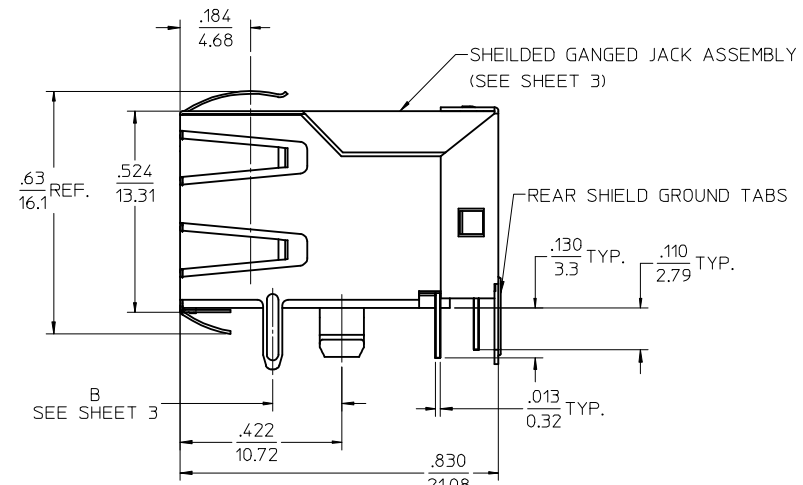
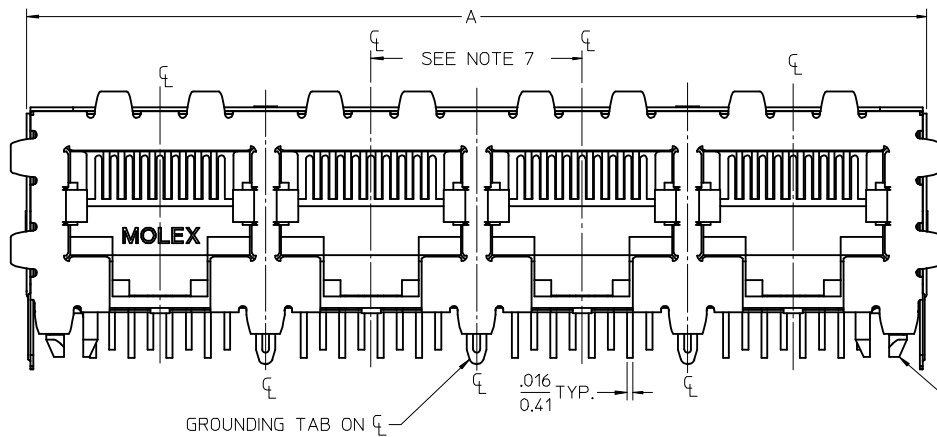

SUGGESTED PANEL OPENING  
 .015 TOP OF PCB TO BOTTOM OF OPENING  
 .038

SCALE : 2/1

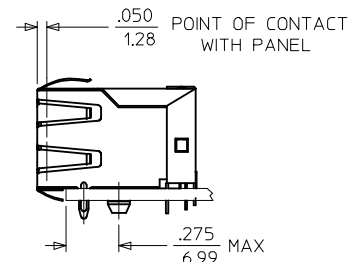

4 PORT 8 LOADED  
 8 JACK SHOWN

- NOTES:
- MATERIAL:  
 HOUSING: GLASS FILLED NYLON, UL94V-0, COLOR: BLACK  
 INSULATOR: GLASS FILLED NYLON, UL94V-0, COLOR: BLACK  
 TERMINALS: PHOSPHOR BRONZE: .012/ 0.30 THICK  
 SHIELD: BRASS, FRONT .007/ 0.18 THICK, REAR .010/ 0.25 THICK
  - FINISH:  
 TERMINALS:  
 SELECT GOLD IN CONTACT AREA: 50 MICROINCHES/ 1.27 MICROMETERS MIN.,  
 \*SELECT TIN IN PC TAIL AREA: 100 MICROINCHES/ 2.54 MICROMETERS MIN.,  
 WITH OVERALL NICKEL UNDERPLATE: 50 MICROINCHES/ 1.27 MICROMETERS MIN.  
 SHIELD:  
 \*100 MICROINCHES/ 2.54 MICROMETERS NICKEL OVER 50 MICROINCHES/ 1.27 MICROMETERS COPPER UNDERPLATE. PCB GROUND TABS DIPPED IN TIN  
 \*THE PRIMARY SHIPPING CARTON WILL BE LABELED "COMPLIANT TO RoHS DIRECTIVE 2002/95/EC AND ELV ANNEX II OF DIRECTIVE 2000/53/EC". CARTONS WITHOUT THIS LABEL MAY CONTAIN PRODUCT WITH TIN-LEAD IN THE PC TAIL AND/OR SHIELD.
  - PRODUCT SPECIFICATION AND PROCESSING PARAMETERS: PS-43223-001.
  - PACKAGING SPECIFICATION:  
 SHIELDED CONNECTOR ASSEMBLIES PACKAGED IN TRAYS PER MOLEX PACKAGING SPECIFICATION PK-44150-004.
  - SEE SHEETS 4-6 FOR P.C. BOARD LAYOUTS.
  - REAR SHIELD IS AVAILABLE WITH (1) CENTERED GROUND TAB ON 4 & 8 PORT VERSIONS.
  - 8 CIRCUIT JACKS CENTERLINE TO CENTERLINE SPACING IS .550/ 13.97.
  - ALL UNTOLERANCED DIMENSIONS ARE SHOWN FOR REFERENCE ONLY.
  - THIS PART CONFORMS TO CLASS B REQUIREMENTS OF COSMETIC SPECIFICATION PS-45499-002.

HOUSING SIZE	CIRCUIT SIZE	NO. OF PORTS	DIM. A	DIM. C	DIM. D	DIM. E
8	8	2	1.224 (31.09)	.350 (8.89)	1.000 (25.40)	1.255 (31.88)
8	8	4	2.324 (59.03)	.350 (8.89)	2.100 (53.34)	2.355 (59.82)
8	8	6	3.424 (86.97)	.350 (8.89)	3.200 (81.28)	3.455 (87.76)
8	8	8	4.524 (114.91)	.350 (8.89)	4.300 (109.22)	4.555 (115.97)
8	2	8	4.524 (114.91)	.050 (1.27)	4.300 (109.22)	4.555 (115.97)

SEE SHEET 1 EC NO: UCP2009-0477 DRWN:JBELL CHKD:JBELL APPR:FSMITH 2008/09/05 2008/09/11 2008/09/11	QUALITY SYMBOLS ▽=0 ▽=0	GENERAL TOLERANCES (UNLESS SPECIFIED) mm INCH 4 PLACES ± --- ± --- 3 PLACES ± --- ± .015 2 PLACES ± 0.38 ± --- 1 PLACE ± --- ± --- ANGULAR ± 1/2°	DIMENSION STYLE IN/MM DRAWN BY DATE JTR 1993/10/18 CHECKED BY DATE JTR 1993/10/18 APPROVED BY DATE RAS 1993/10/18	SCALE 4:1 DESIGN UNITS INCH THIRD ANGLE PROJECTION	TITLE LOW PROFILE GANGED, RIGHT ANGLE MODULAR JACK ASSEMBLY MOLEX MOLEX INCORPORATED MATERIAL NO. SEE SHTS 3 DOCUMENT NO. SDA-43223	SHEET NO. 2 OF 6	
	DRAFT WHERE APPLICABLE MUST REMAIN WITHIN DIMENSIONS		THIS DRAWING CONTAINS INFORMATION THAT IS PROPRIETARY TO MOLEX INCORPORATED AND SHOULD NOT BE USED WITHOUT WRITTEN PERMISSION				
	K1		SIZE C				

FLUSH MOUNT (UNSHIELDED)

ASSEMBLY NUMBER	CONNECTOR SIZE	NUMBER OF CIRCUITS	NUMBER OF PORTS	PACKAGING STYLE	PACKAGING SPECIFICATION
43223-6001	6	6	2	TRAY	PK-43249-004
43223-6004	6	6	3	↑	↑
43223-6007	6	6	4		
43223-6010	6	6	5		
43223-6013	6	6	6		
43223-6019	6	6	8		
43223-6022	6	4	2		
43223-6025	6	4	3		
43223-6028	6	4	4		
43223-6031	6	4	5		
43223-6034	6	4	6		
43223-6040	6	4	8		
43223-6043	6	2	2		
43223-6046	6	2	3		
43223-6049	6	2	4		
43223-6052	6	2	5		
43223-6055	6	2	6	↓	↓
43223-6058	6	2	8	TRAY	PK-43249-004

43223-8001	8	10	2	TRAY	PK-43249-004
43223-8004	8	10	3	↑	↑
43223-8007	8	10	4		
43223-8010	8	10	5		
43223-8013	8	10	6		
43223-8019	8	10	8		
43223-8022	8	8	2		
43223-8025	8	8	3		
43223-8028	8	8	4		
43223-8031	8	8	5		
43223-8034	8	8	6		
43223-8040	8	8	8		
43223-8041	8	4	5	↓	↓
43223-8042	8	6	3	TRAY	PK-43249-004

FLANGELESS (UNSHIELDED)

ASSEMBLY NUMBER	CONNECTOR SIZE	NUMBER OF CIRCUITS	NUMBER OF PORTS	PACKAGING STYLE	PACKAGING SPECIFICATION
43223-6101	6	6	2	TRAY	PK-43249-004
43223-6104	6	6	3	↑	↑
43223-6107	6	6	4		
43223-6110	6	6	5		
43223-6113	6	6	6		
43223-6119	6	6	8		
43223-6122	6	4	2		
43223-6125	6	4	3		
43223-6128	6	4	4		
43223-6131	6	4	5		
43223-6134	6	4	6		
43223-6140	6	4	8		
43223-6143	6	2	2		
43223-6146	6	2	3		
43223-6149	6	2	4		
43223-6152	6	2	5		
43223-6155	6	2	6	↓	↓
43223-6158	6	2	8	TRAY	PK-43249-004

43223-8101	8	10	2	TRAY	PK-43249-004
43223-8104	8	10	3	↑	↑
43223-8107	8	10	4		
43223-8110	8	10	5		
43223-8113	8	10	6		
43223-8119	8	10	8		
43223-8122	8	8	2		
43223-8131	8	8	3		
43223-8140	8	8	4		
43223-8149	8	8	5		
43223-8158	8	8	6	↓	↓
43223-8176	8	8	8	TRAY	PK-43249-004

43223-8191	8	6	2	TUBE	PK-43249-005
43223-8192	8	4	4	TUBE	PK-43249-005
43223-8193	8	4	3	TUBE	PK-43249-005
43223-8195	8	8	2	TUBE	PK-43249-005
43223-8196	8	8	3	TUBE	PK-43249-005
43223-8197	8	8	4	TUBE	PK-43249-005

FLANGELESS (SHIELDED)

ASSEMBLY NUMBER	DIMENSION "B"	CONNECTOR SIZE	NUMBER OF CIRCUITS	NUMBER OF PORTS	NUMBER OF REAR SHIELD GROUND TABS	PACKAGING STYLE	PACKAGING SPECIFICATION
43223-8128	.180	8	8	2	1	TRAY	PK-44150-004
43223-8146	.180	8	8	4	3	↑	↑
43223-8164	.180	8	8	6	5		
43223-8182	.180	8	8	8	7		
43223-8185	.180	8	8	8	1		
43223-8188	.180	8	8	4	1	↓	↓
43223-8194	.180	8	2	8	7	TRAY	PK-44150-004

43223-8301	.145	8	8	2	1	TRAY	PK-44150-004
43223-8302	.145	8	8	4	3	↑	↑
43223-8303	.145	8	8	6	5		
43223-8304	.145	8	8	8	7		
43223-8305	.145	8	8	8	1		
43223-8306	.145	8	8	4	1	↓	↓
43223-8307	.145	8	2	8	7	TRAY	PK-44150-004

SNAP FIT PEG VERSIONS

SEE SHEET 1 EC NO: UCP2009-0477 DRWN:JBELL 2008/09/05 CHKD:JBELL 2008/09/11 APPR:FSM.LTH 2008/09/11 K1	QUALITY SYMBOLS ▽=0 ▽=0	GENERAL TOLERANCES (UNLESS SPECIFIED)	DIMENSION STYLE IN/MM	SCALE 2:1	DESIGN UNITS INCH	THIRD ANGLE PROJECTION
		4 PLACES ± --- INCH 3 PLACES ± --- ±.015 2 PLACES ± 0.38 ± --- 1 PLACE ± --- ± ---	DRAWN BY DATE JTR 1993/10/18 CHECKED BY DATE JTR 1993/10/18 APPROVED BY DATE RAS 1993/10/18	LOW PROFILE GANGED, RIGHT ANGLE MODULAR JACK ASSEMBLY		
		ANGULAR ±1/2° DRAFT WHERE APPLICABLE MUST REMAIN WITHIN DIMENSIONS	MATERIAL NO. SEE CHART SIZE C	MOLEX MOLEX INCORPORATED SDA-43223	SHEET NO. 3 OF 6	
		THIS DRAWING CONTAINS INFORMATION THAT IS PROPRIETARY TO MOLEX INCORPORATED AND SHOULD NOT BE USED WITHOUT WRITTEN PERMISSION				

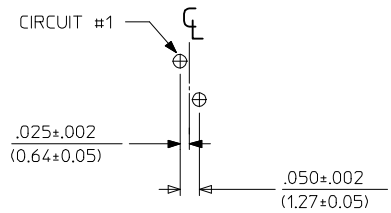

6 LOADED 2 DETAIL  
SCALE: 4/1

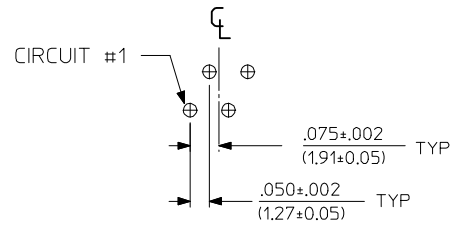

6 LOADED 4 DETAIL  
SCALE: 4/1

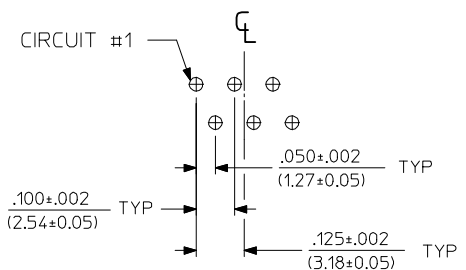

6 LOADED 6 DETAIL  
SCALE: 4/1

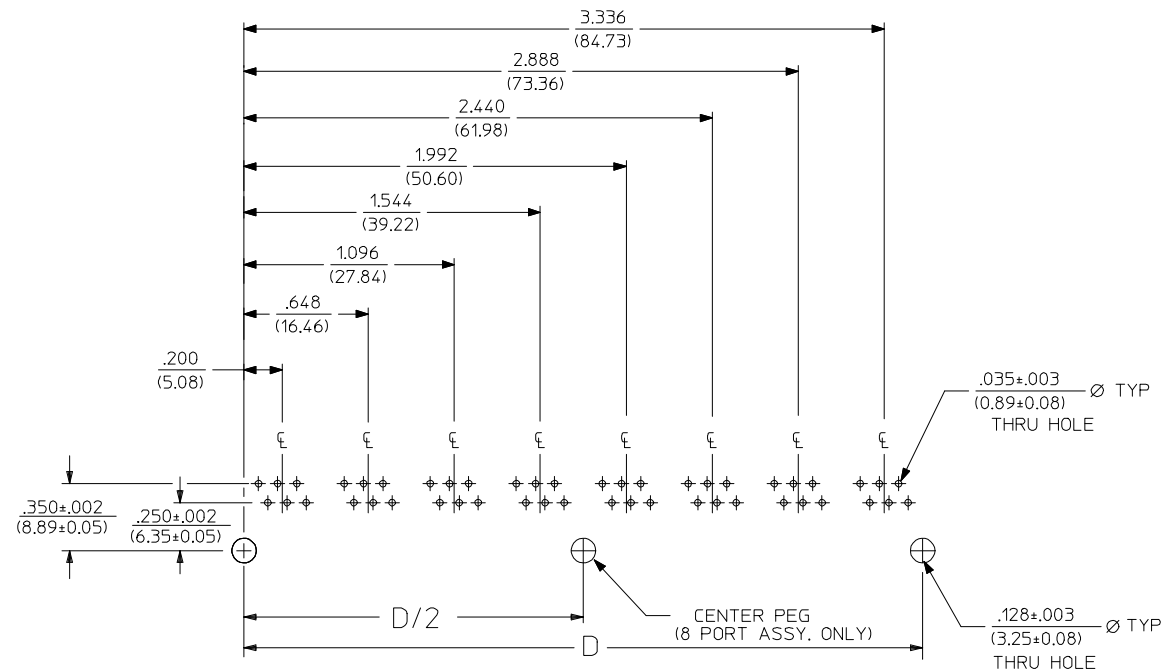

SUGGESTED P.C. BOARD LAYOUT  
COMPONENT SIDE OF BOARD  
8 PORT, 6 LOADED 6, LAYOUT SHOWN  
(SNAP-FIT VERSIONS)

NOTES:  
1. RECOMMENDED PCB THICKNESS .062±.005/(1.57±0.13)

NUMBER OF PORTS	DIM. D
2	.848 (21.54)
3	1.296 (32.92)
4	1.744 (44.30)
5	2.192 (55.68)
6	2.640 (67.06)
8	3.536 (89.81)

SEE SHEET 1 EC NO: UCP2009-0477 DRWN:JBELL 2008/09/05 CHKD:JBELL 2008/09/11 APPR:FSM1TH 2008/09/11 K1	QUALITY SYMBOLS ▽=0 ▽=0	GENERAL TOLERANCES (UNLESS SPECIFIED)		DIMENSION STYLE IN/MM	SCALE 2:1	DESIGN UNITS INCH	THIRD ANGLE PROJECTION	
		4 PLACES ± --- ± --- 3 PLACES ± --- ±.015 2 PLACES ± 0.38 ± --- 1 PLACE ± --- ± --- ANGULAR ±1/2°	DRAWN BY JTR DATE 1993/10/18	CHECKED BY JTR DATE 1993/10/18	TITLE LOW PROFILE GANGED, RIGHT ANGLE MODULAR JACK ASSEMBLY			
		DRAFT WHERE APPLICABLE MUST REMAIN WITHIN DIMENSIONS	APPROVED BY RAS DATE 1993/10/18	MATERIAL NO. SEE SHT 3	MOLEX INCORPORATED	DOCUMENT NO. SDA-43223	SHEET NO. 4 OF 6	
		THIS DRAWING CONTAINS INFORMATION THAT IS PROPRIETARY TO MOLEX INCORPORATED AND SHOULD NOT BE USED WITHOUT WRITTEN PERMISSION						

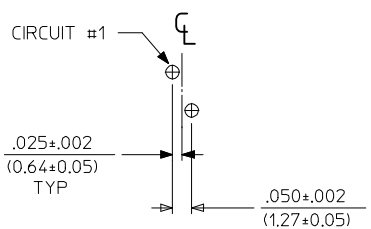

8 LOADED 2 DETAIL  
SCALE: 4/1

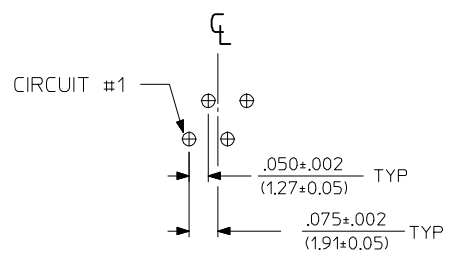

8 LOADED 4 DETAIL  
SCALE: 4/1

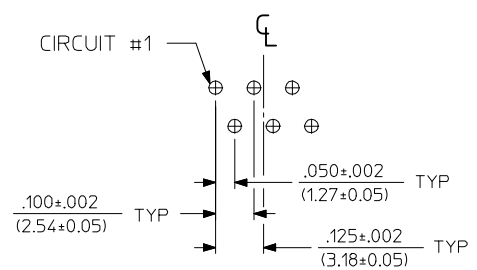

8 LOADED 6 DETAIL  
SCALE: 4/1

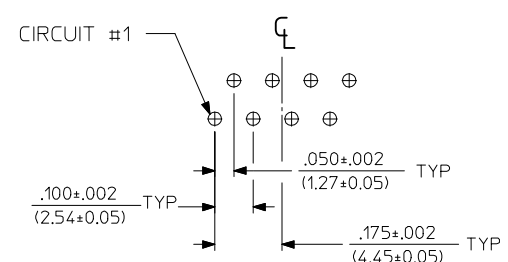

8 LOADED 8 DETAIL  
SCALE: 4/1

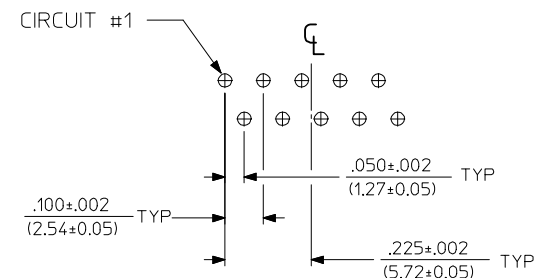

8 LOADED 10 DETAIL  
SCALE: 4/1

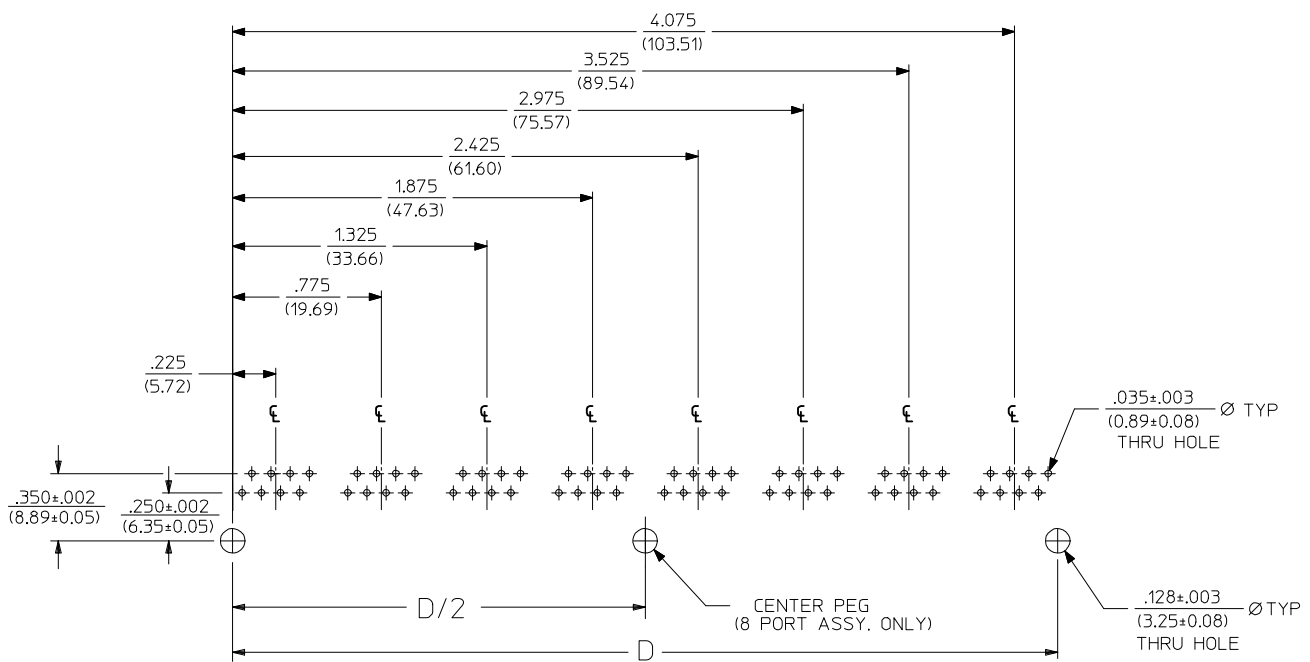

SUGGESTED P.C. BOARD LAYOUT  
COMPONENT SIDE OF BOARD  
8 PORT, 8 LOADED 8  
(SNAP-FIT VERSIONS)

NOTES:  
1. RECOMMENDED PCB THICKNESS: .062±.005/(1.57±0.13)

NUMBER OF PORTS	DIM. D
2	1.000 (25.40)
3	1.550 (39.37)
4	2.100 (53.34)
5	2.650 (67.31)
6	3.200 (81.28)
8	4.300 (109.32)

SEE SHEET 1	QUALITY SYMBOLS
EC NO: UCP2009-0477	▽=0
DRWN:JBELL 2008/09/05	▽=0
CHKD:JBELL 2008/09/11	
APPR:FSM/TH 2008/09/11	
REV	DESCRIPTION
K1	

GENERAL TOLERANCES (UNLESS SPECIFIED)	
	mm INCH
4 PLACES ±	± .015
3 PLACES ±	± .015
2 PLACES ±	± .038
1 PLACE ±	± .075
ANGULAR ±1/2°	
DRAFT WHERE APPLICABLE MUST REMAIN WITHIN DIMENSIONS	

DIMENSION STYLE	
IN/MM	
DRAWN BY	DATE
JTR	1993/10/18
CHECKED BY	DATE
JTR	1993/10/18
APPROVED BY	DATE
RAS	1993/10/18
MATERIAL NO.	DOCUMENT NO.
SEE SHT 3	SDA-43223
SIZE	THIS DRAWING CONTAINS INFORMATION THAT IS PROPRIETARY TO MOLEX INCORPORATED AND SHOULD NOT BE USED WITHOUT WRITTEN PERMISSION

SCALE	DESIGN UNITS	THIRD ANGLE PROJECTION
2:1	INCH	
MOLEX INCORPORATED		
SHEET NO.		5 OF 6

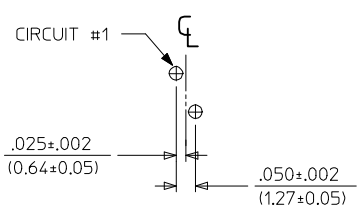

8 LOADED 2 DETAIL  
SCALE: 4/1

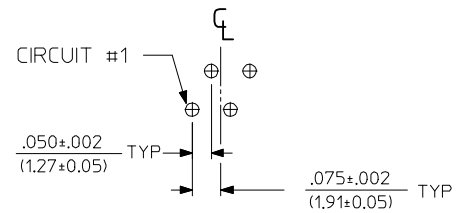

8 LOADED 4 DETAIL  
SCALE: 4/1

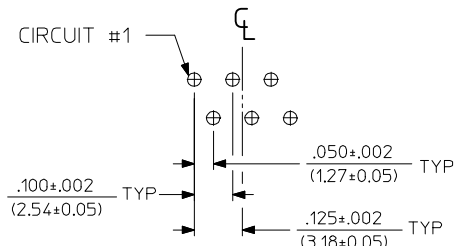

8 LOADED 6 DETAIL  
SCALE: 4/1

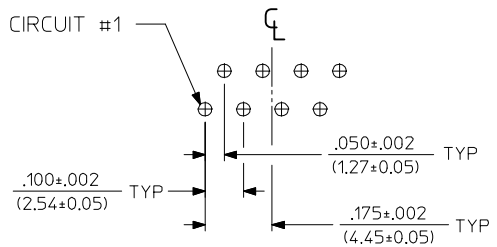

8 LOADED 8 DETAIL  
SCALE: 4/1

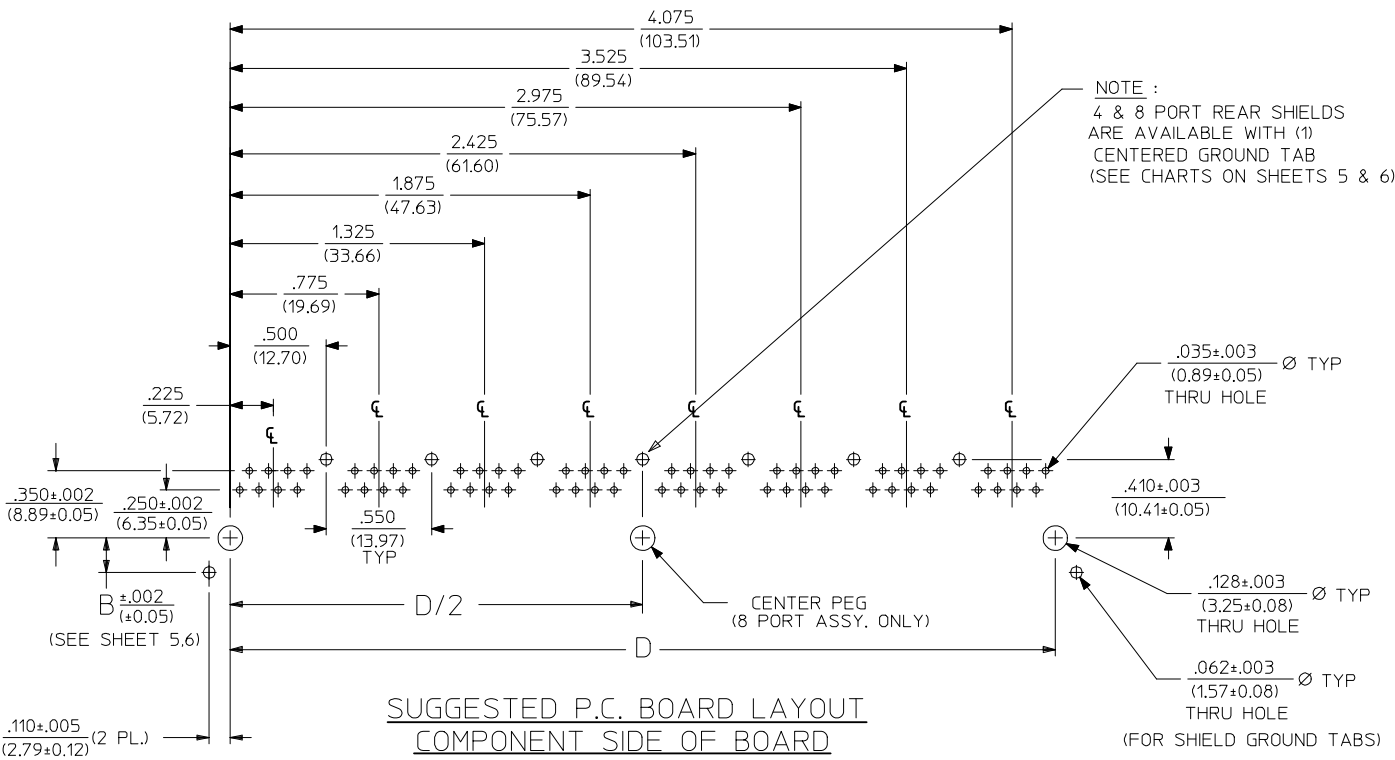

NOTE:  
4 & 8 PORT REAR SHIELDS  
ARE AVAILABLE WITH (1)  
CENTERED GROUND TAB  
(SEE CHARTS ON SHEETS 5 & 6)

SUGGESTED P.C. BOARD LAYOUT  
COMPONENT SIDE OF BOARD  
8 PORT, 8 LOADED 8  
(SHIELDED) LAYOUT SHOWN  
(SNAP-FIT VERSIONS)

NOTES:  
1. RECOMMENDED PCB THICKNESS: .062±.005/(1.57±0.13)

NUMBER OF PORTS	DIM. D
2	1.000 (25.40)
4	2.100 (53.34)
6	3.200 (81.28)
8	4.300 (109.32)

SEE SHEET 1 EC NO: UCP2009-0477 DRWN:JBELL 2008/09/05 CHKD:JBELL 2008/09/11 APPR:FSM/TH 2008/09/11 K1	QUALITY SYMBOLS ▽=0 ▽=0	GENERAL TOLERANCES (UNLESS SPECIFIED) <table border="1"> <thead> <tr> <th></th> <th>mm</th> <th>INCH</th> </tr> </thead> <tbody> <tr> <td>4 PLACES</td> <td>± .---</td> <td>± .---</td> </tr> <tr> <td>3 PLACES</td> <td>± .---</td> <td>± .015</td> </tr> <tr> <td>2 PLACES</td> <td>± 0.38</td> <td>± .---</td> </tr> <tr> <td>1 PLACE</td> <td>± .---</td> <td>± .---</td> </tr> </tbody> </table>		mm	INCH	4 PLACES	± .---	± .---	3 PLACES	± .---	± .015	2 PLACES	± 0.38	± .---	1 PLACE	± .---	± .---	DIMENSION STYLE IN/MM	SCALE 2:1	DESIGN UNITS INCH	THIRD ANGLE PROJECTION
		mm	INCH																		
	4 PLACES	± .---	± .---																		
	3 PLACES	± .---	± .015																		
2 PLACES	± 0.38	± .---																			
1 PLACE	± .---	± .---																			
DRAFT WHERE APPLICABLE MUST REMAIN WITHIN DIMENSIONS		MATERIAL NO. SEE SHT 3	DRAWN BY JTR	DATE 1993/10/18	TITLE LOW PROFILE GANGED, RIGHT ANGLE MODULAR JACK ASSEMBLY																
		APPROVED BY RAS	DATE 1993/10/18	MOLEX INCORPORATED																	
		SIZE C	THIS DRAWING CONTAINS INFORMATION THAT IS PROPRIETARY TO MOLEX INCORPORATED AND SHOULD NOT BE USED WITHOUT WRITTEN PERMISSION			SHEET NO. 6 OF 6															