

Compact 1-stage filter for 3-phase systems with neutral conductor



Description

- Quick-connect terminals 6.3 x 0.8 for three phases, neutral conductor and ground
- Very high symmetrical and asymmetrical attenuation loss
- In the frequency range from 10kHz up to 300MHz

Standards

- IEC 60939
- UL 1283

Approvals

- VDE License Number: 40004673

Applications

- Especially designed for industrial applications such as: Frequency Converters, Stepper Motor Drives, UPS-Systems, Inverters
- Qualified for use in equipment according IEC/EN 60950

References

[General Product Information](#)

Weblinks

[Approvals](#), [RoHS](#), [CHINA-RoHS](#), [e-Store](#), [Distributor-Stock-Check](#)

Technical Data

Rated Current	3 - 20A @ Ta 40 °C
Rated voltage	250 / 440VAC, 50/60 Hz
Approval for	3 - 20A / 440VAC; 50Hz
Overload Current	1.5 x Ir
Leakage Current	industrial < 3mA (440V / 50Hz)
Dielectric Strength for 480 VAC	2.25kVDC between L-L 1.7kVDC between L-N 3kVDC between L-PE 2.7kVDC between N-PE Test voltage (2 sec)
Number of Filter Stages	1
Weight	0.2 - 0.35 kg
Material: Housing	Metal
Sealing Compound	UL 94V-0

Mounting	Screw-on mounting on chassis, from top
Terminal	Quick connect terminals 6.3 x 0.8 mm
Operating Temperature [°C]	-25 °C to 100 °C
Climatic Category	25/100/21 acc. to IEC 60068-1
Degree of Protection	IP 20 acc. to IEC 60529
Protection Class	Suitable for appliances with protection class 1 acc. to IEC 61140
MTBF	> 200'000h acc. to MIL-HB-217 F

Dimensions

Case 47

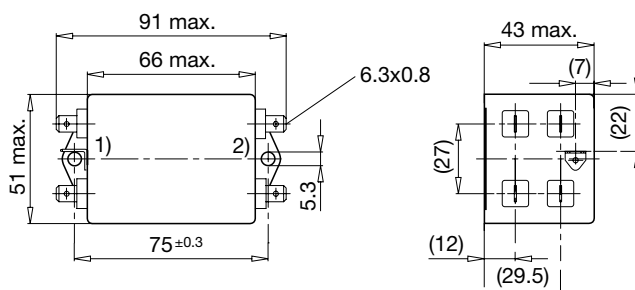

- 1) Line
- 2) Load

Diagrams

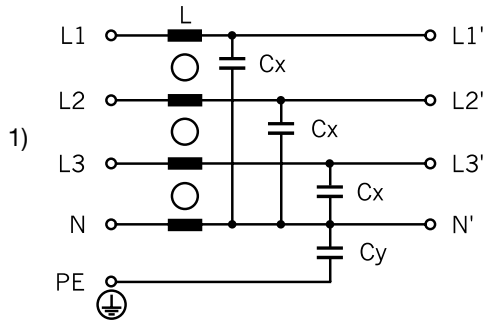

1) Power Line

Attenuation Loss

--- differential mode ____ common mode

Standard version
3A (FMW-65-0001)

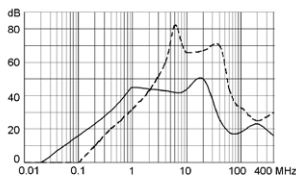

6A (FMW-65-0002)

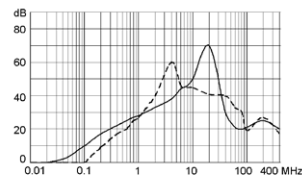

10A (FMW-65-0003)

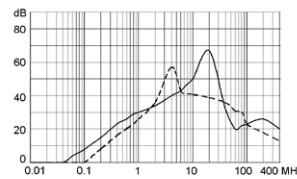

Industrial Version
10A (FMW-65-0004)

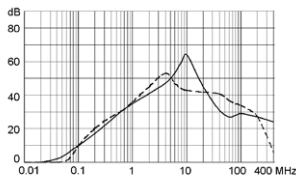

20A (FMW-65-0005)

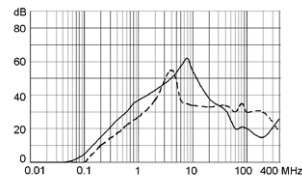

Variants

Rated Current [A]	Rated Voltage [VAC]	Leakage Current [mA]	L [mH]	Cx [μ F]	Cy [nF]	Weight [kg]	Housing	Order Number
3	250/440	0.5	1	0.1	4.7	0.2	47	FMW-65-0001
6	250/440	0.5	0.5	0.1	4.7	0.2	47	FMW-65-0002
10	250/440	0.5	0.4	0.1	4.7	0.23	47	FMW-65-0003
10	250/440	3	0.4	0.1	22	0.35	47	FMW-65-0004
20	250/440	3	0.15	0.1	22	0.25	47	FMW-65-0005

Packaging unit 10 Pcs