



SPN9977

N-Channel Enhancement Mode MOSFET

DESCRIPTION

The SPN9977 is the N-Channel logic enhancement mode power field effect transistors are produced using super high cell density , DMOS trench technology. The SPN9977 has been designed specifically to improve the overall efficiency of DC/DC converters using either synchronous or conventional switching PWM controllers. It has been optimized for low gate charge, low $R_{DS(ON)}$ and fast switching speed.

FEATURES

- ◆ 60V/8A, $R_{DS(ON)} = 115m\Omega @ V_{GS} = 10V$
- ◆ 60V/6A, $R_{DS(ON)} = 110m\Omega @ V_{GS} = 4.5V$
- ◆ High density cell design for extremely low RDS (ON)
- ◆ Exceptional on-resistance and maximum DC current capability
- ◆ TO-252, TO-251 package design

APPLICATIONS

- Power Management in Note book
- Powered System
- DC/DC Converter
- Load Switch

PIN CONFIGURATION

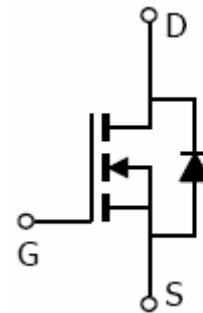
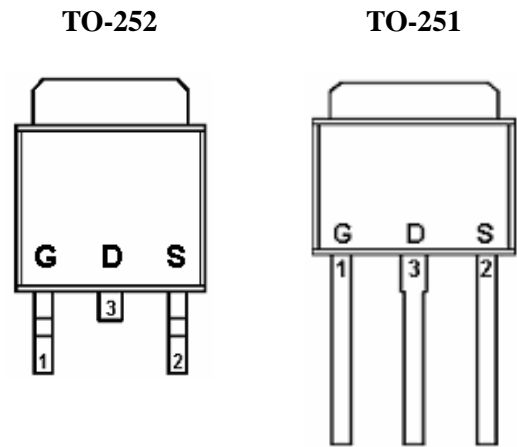

PART MARKING

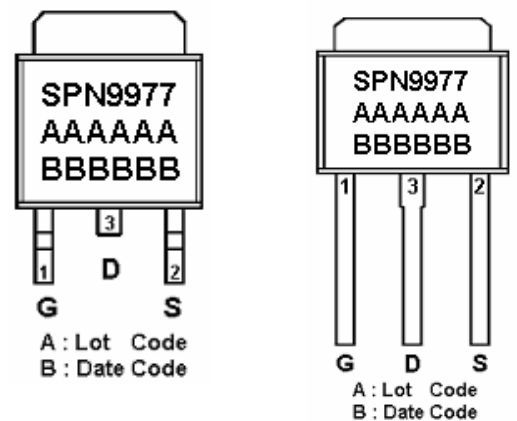



SPN9977

N-Channel Enhancement Mode MOSFET

PIN DESCRIPTION

Pin	Symbol	Description
1	G	Gate
2	S	Source
3	D	Drain

ORDERING INFORMATION

Part Number	Package	Part Marking
SPN9977T252RGB	TO-252	SPN9977
SPN9977T251TGB	TO-251	SPN9977

※ SPN9977T252RGB : Tape Reel ; Pb – Free ; Halogen - Free

※ SPN9977T251RGB : Tube ; Pb – Free ; Halogen - Free

ABSOLUTE MAXIMUM RATINGS

(TA=25°C Unless otherwise noted)

Parameter	Symbol	Typical	Unit	
Drain-Source Voltage	V _{DSS}	60	V	
Gate –Source Voltage	V _{GSS}	±20	V	
Continuous Drain Current(T _J =150°C)	I _D	TA=25°C	14	A
		TA=70°C	9.0	
Pulsed Drain Current	I _{DM}	45	A	
Avalanche Current	I _{AS}	14	A	
Power Dissipation	P _D	TA=25°C	TO-252-2L	W
		TO-251	55	
Operating Junction Temperature	T _J	150	°C	
Storage Temperature Range	T _{STG}	-55/150	°C	
Thermal Resistance-Junction to Ambient	R _{θJA}	100	°C/W	



SPN9977

N-Channel Enhancement Mode MOSFET

ELECTRICAL CHARACTERISTICS

(TA=25°C Unless otherwise noted)

Parameter	Symbol	Conditions	Min.	Typ	Max.	Unit
Static						
Drain-Source Breakdown Voltage	$V_{(BR)DSS}$	$V_{GS}=0V, I_D=250\mu A$	60			V
Gate Threshold Voltage	$V_{GS(th)}$	$V_{DS}=V_{GS}, I_D=250\mu A$	0.5		1.5	
Gate Leakage Current	I_{GSS}	$V_{DS}=0V, V_{GS}=\pm 20V$			± 100	nA
Zero Gate Voltage Drain Current	I_{DSS}	$V_{DS}=60V, V_{GS}=0V$			1	uA
		$V_{DS}=60V, V_{GS}=0V$ $T_J=85^\circ C$			5	
On-State Drain Current	$I_{D(on)}$	$V_{DS}\geq 5V, V_{GS}=10V$	14			A
Drain-Source On-Resistance	$R_{DS(on)}$	$V_{GS}=10V, I_D=8A$		0.110	0.115	Ω
		$V_{GS}=4.5V, I_D=6A$		0.105	0.110	
Forward Transconductance	g_{fs}	$V_{DS}=15V, I_D=4.3A$		15		S
Diode Forward Voltage	V_{SD}	$I_S=1.7A, V_{GS}=0V$		0.8	1.2	V
Dynamic						
Total Gate Charge	Q_g	$V_{DS}=30V, V_{GS}=10V$ $I_D=4.3A$		15	20	nC
Gate-Source Charge	Q_{gs}			2.5		
Gate-Drain Charge	Q_{gd}			2.6		
Input Capacitance	C_{iss}	$V_{DS}=15V, V_{GS}=0V$ $f=1MHz$		675		pF
Output Capacitance	C_{oss}			80		
Reverse Transfer Capacitance	C_{rss}			40		
Turn-On Time	$t_{d(on)}$	$V_{DD}=30V, R_L=8.8\Omega$ $I_D=3.4A, V_{GEN}=10V$ $R_G=1\Omega$		10	20	nS
	t_r			15	25	
Turn-Off Time	$t_{d(off)}$			25	35	
	t_f			12	20	



SPN9977

N-Channel Enhancement Mode MOSFET

TYPICAL CHARACTERISTICS

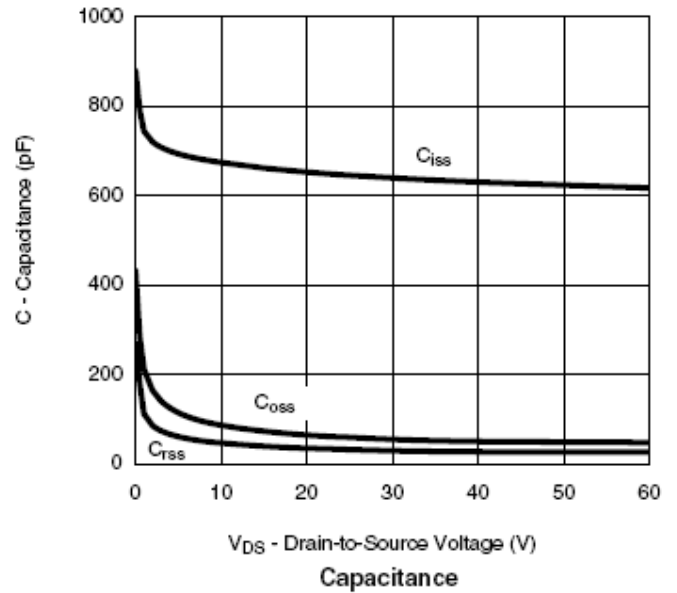
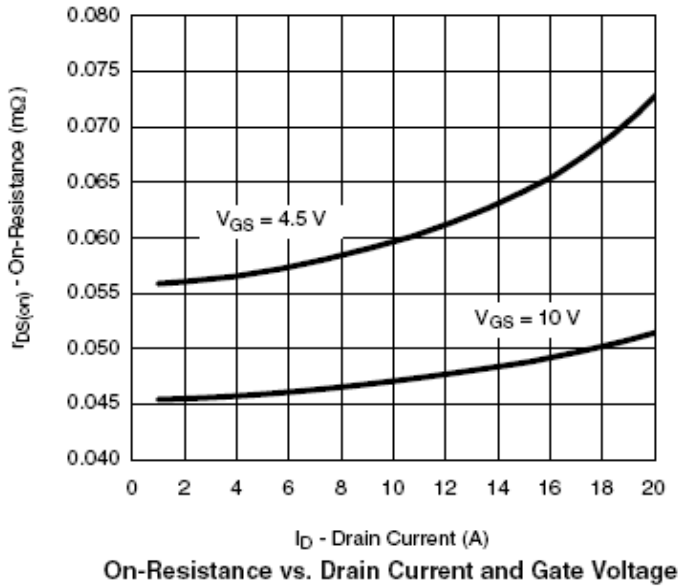
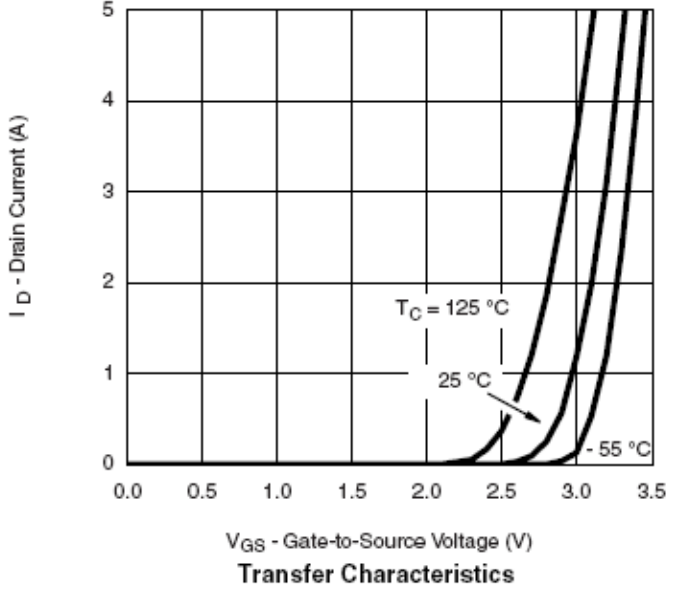
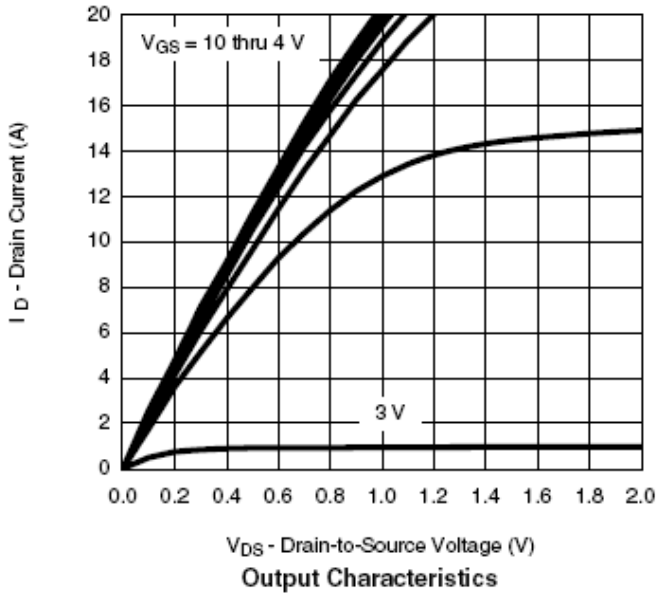



SPN9977

N-Channel Enhancement Mode MOSFET

TYPICAL CHARACTERISTICS

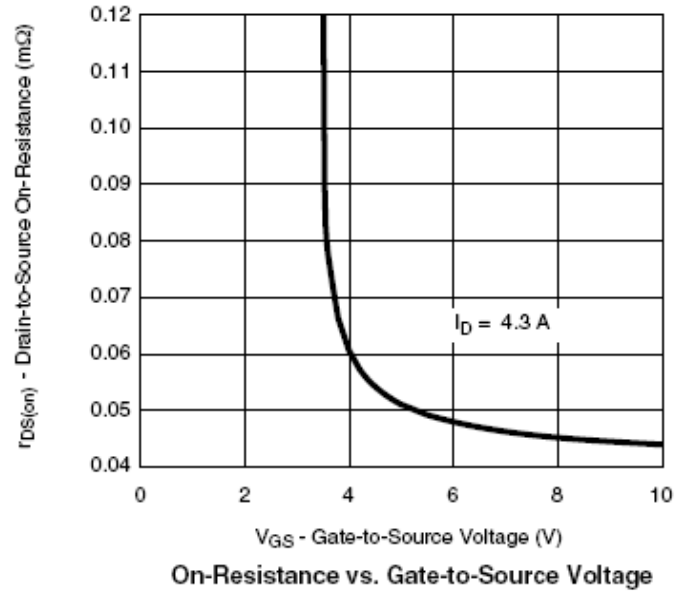
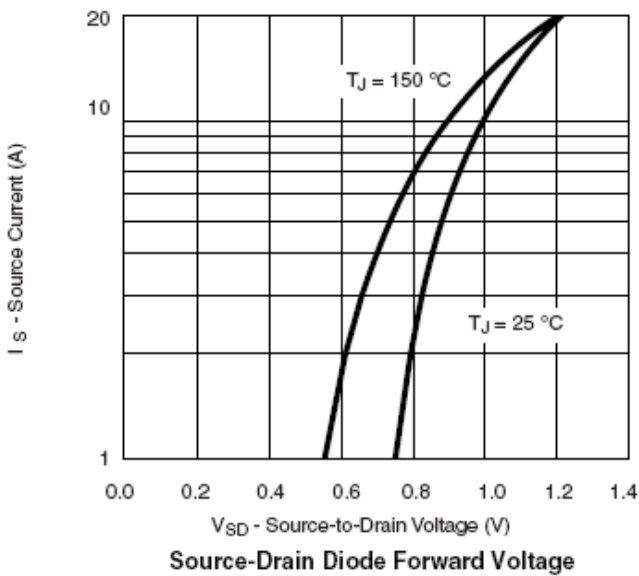
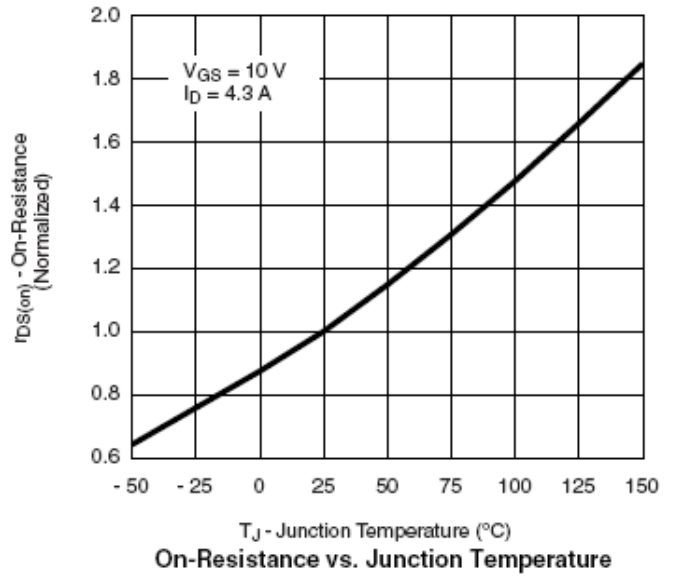
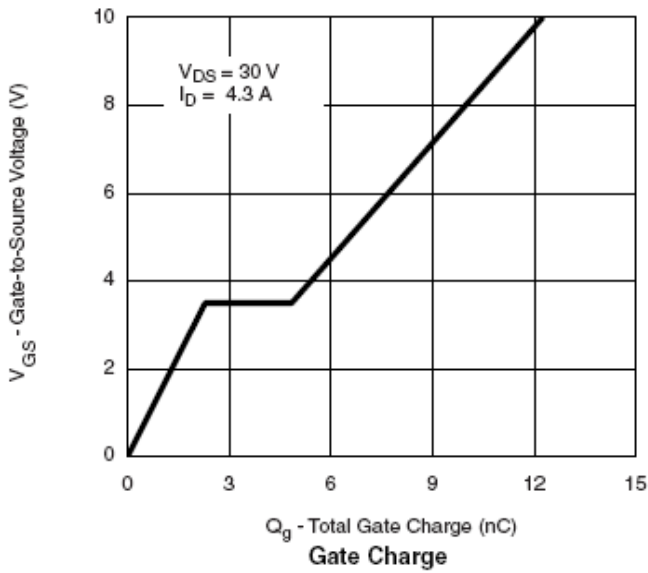



SPN9977 N-Channel Enhancement Mode MOSFET

TYPICAL CHARACTERISTICS

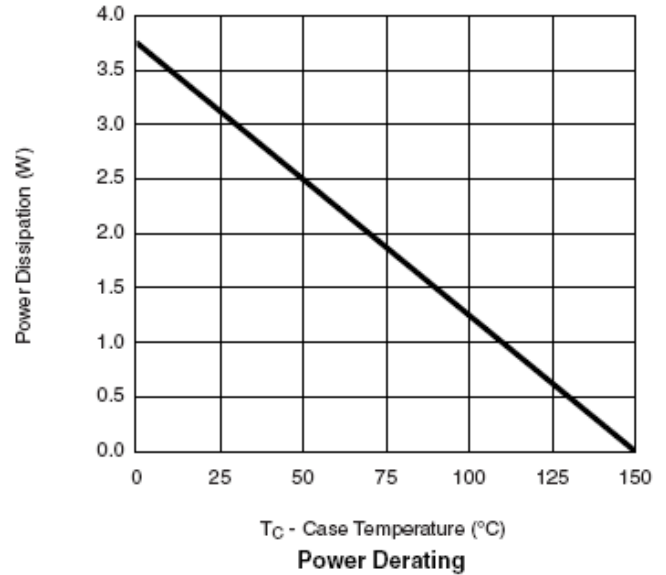
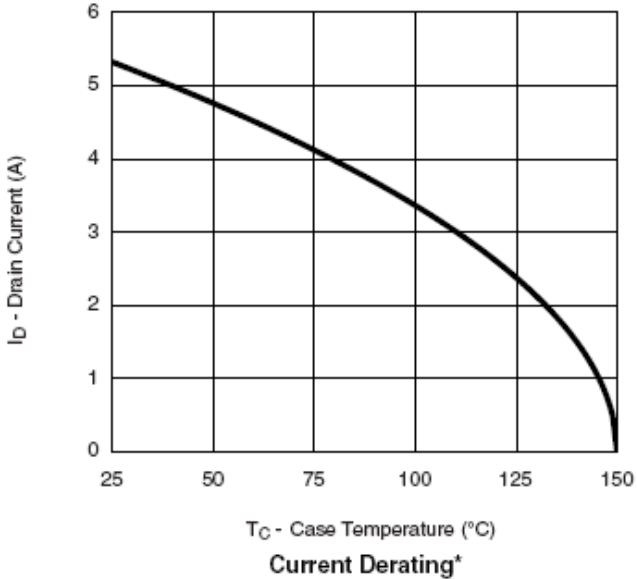
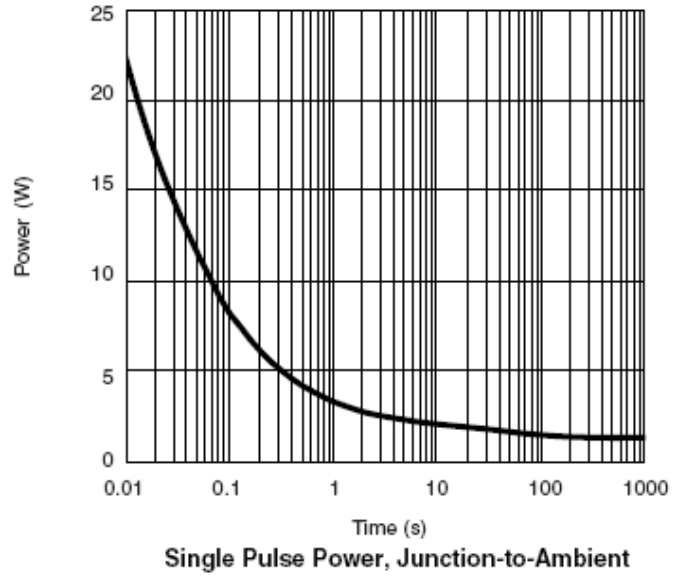
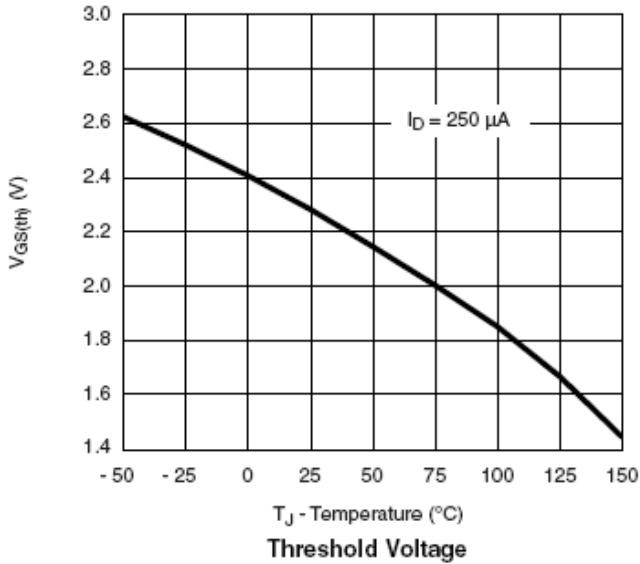



SPN9977 N-Channel Enhancement Mode MOSFET

TYPICAL CHARACTERISTICS

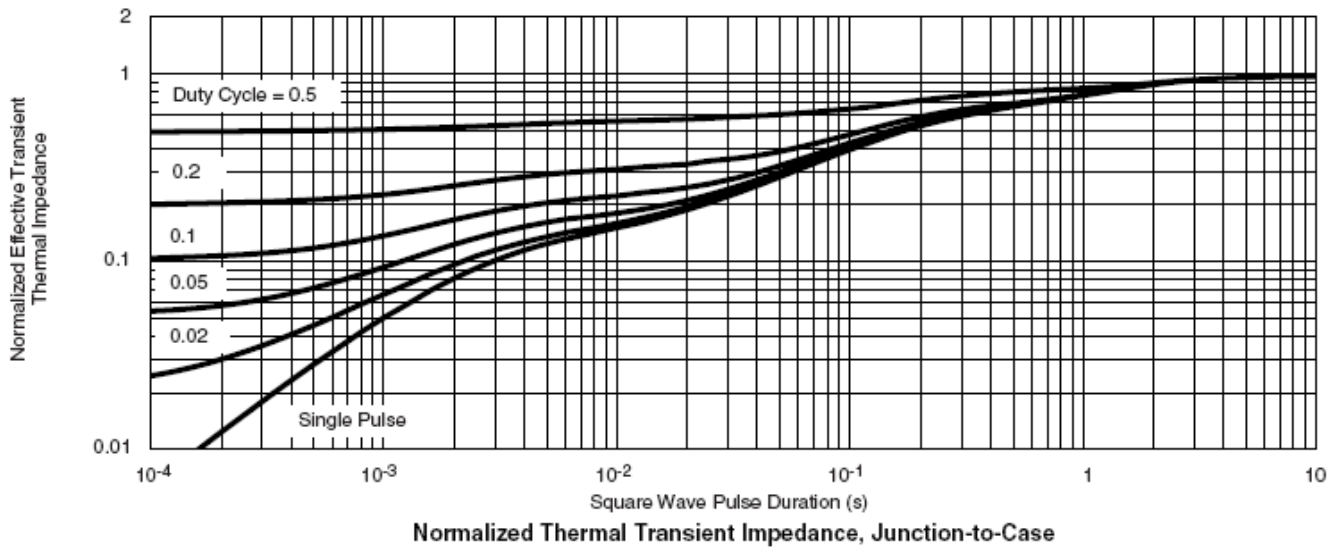
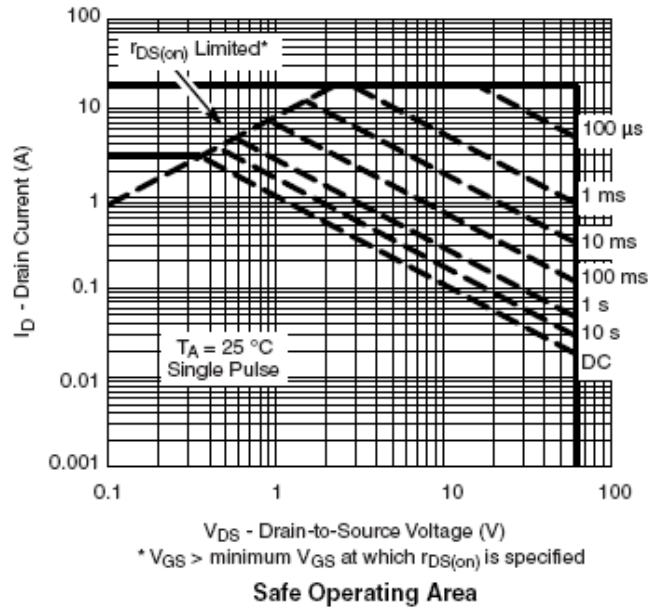
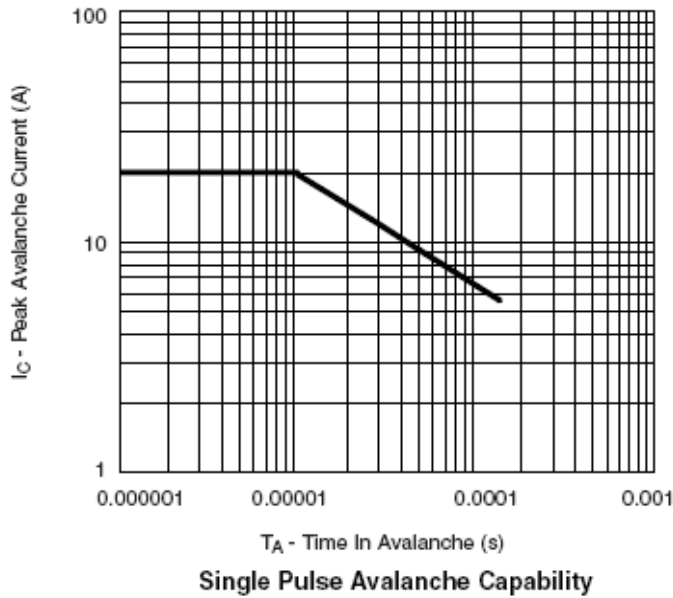



SPN9977

N-Channel Enhancement Mode MOSFET

TO-252 PACKAGE OUTLINE

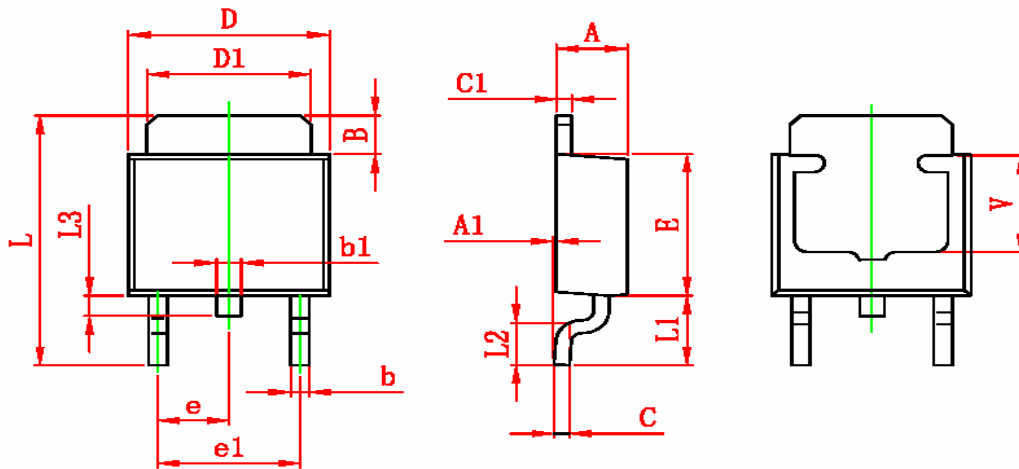

Symbol	Dimensions In Millimeters		Dimensions In Inches	
	Min	Max	Min	Max
A	2.200	2.400	0.087	0.094
A1	0.000	0.127	0.000	0.005
B	1.350	1.650	0.053	0.065
b	0.500	0.700	0.020	0.028
b1	0.700	0.900	0.028	0.035
c	0.430	0.580	0.017	0.023
c1	0.430	0.580	0.017	0.023
D	6.350	6.650	0.250	0.262
D1	5.200	5.400	0.205	0.213
E	5.400	5.700	0.213	0.224
e	2.300 TYP		0.091 TYP	
e1	4.500	4.700	0.177	0.185
L	9.500	9.900	0.374	0.390
L1	2.550	2.900	0.100	0.114
L2	1.400	1.780	0.055	0.070
L3	0.350	0.650	0.014	0.026
V	3.80 REF		0.150 REF	



SPN9977

N-Channel Enhancement Mode MOSFET

TO-251 PACKAGE OUTLINE

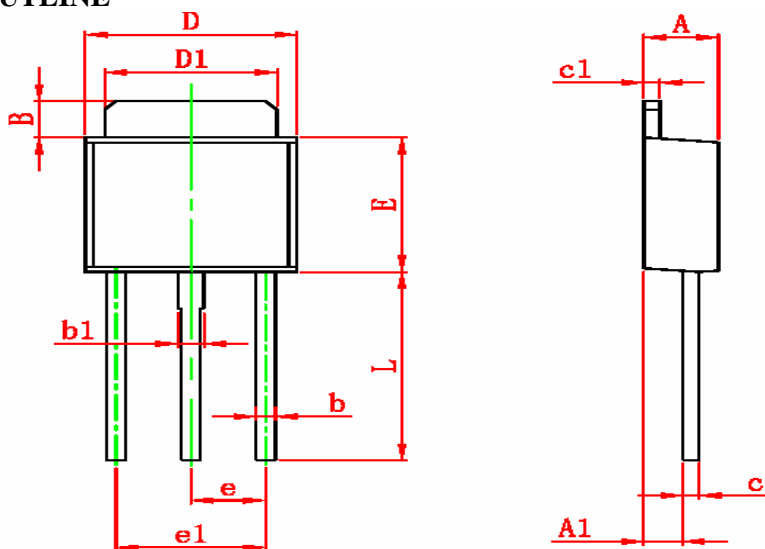

Symbol	Dimensions In Millimeters		Dimensions In Inches	
	Min	Max	Min	Max
A	2.200	2.400	0.087	0.094
A1	1.020	1.270	0.040	0.050
B	1.350	1.650	0.053	0.065
b	0.500	0.700	0.020	0.028
b1	0.700	0.900	0.028	0.035
c	0.430	0.580	0.017	0.023
c1	0.430	0.580	0.017	0.023
D	6.350	6.650	0.250	0.262
D1	5.200	5.400	0.205	0.213
E	5.400	5.700	0.213	0.224
e	2.300 TYP		0.091 TYP	
e1	4.500	4.700	0.177	0.185
L	7.500	7.900	0.295	0.311



SPN9977

N-Channel Enhancement Mode MOSFET

Information provided is alleged to be exact and consistent. SYNC Power Corporation presumes no responsibility for the penalties of use of such information or for any violation of patents or other rights of third parties which may result from its use. No license is granted by allegation or otherwise under any patent or patent rights of SYNC Power Corporation. Conditions mentioned in this publication are subject to change without notice. This publication surpasses and replaces all information previously supplied. SYNC Power Corporation products are not authorized for use as critical components in life support devices or systems without express written approval of SYNC Power Corporation.

©The SYNC Power logo is a registered trademark of SYNC Power Corporation

©2004 SYNC Power Corporation – Printed in Taiwan – All Rights Reserved

SYNC Power Corporation

7F-2, No.3-1, Park Street

NanKang District (NKSP), Taipei, Taiwan 115

Phone: 886-2-2655-8178

Fax: 886-2-2655-8468

©<http://www.syncpower.com>