

# SMHF Single and Dual DC/DC Converters

## 28 VOLT INPUT – 15 WATT

### FEATURES

- Fully qualified to Class H or K
- -55°C to +125°C operation
- 16 to 40 VDC input
- Fully Isolated
- Rad hard optocoupler feedback
- Fixed frequency, 550 kHz typical
- Topology – Single Ended Forward
- Transient protection 50 V/120 ms
- Inhibit function
- Sync function
- Indefinite short circuit protection
- Undervoltage lockout
- Up to 82% efficiency



### MODELS VDC

SINGLE	DUAL
2.5	±5
3.3	±12
5	±15
12	
15	

### DESCRIPTION

The SMHF Series™ of 28 V DC/DC converters offers a wide input voltage range of 16 to 40 volts and up to 15 watts of output power. The units are capable of withstanding short term transients up to 50 volts. The package is a hermetically sealed, projection-welded metal case. Flanged and non-flanged models are available.

### SCREENING

SMHF converters offer screening options to Space Prototype (O), Class H, or Class K. Radiation tolerant to Radiation Hardness Assurance (RHA) levels of “-” (O) or “R”, per MIL-PRF-38534. Interpoint model numbers use an “O” in the RHA designator position to indicate the “-” (dash) Radiation Hardness Assurance level of MIL-PRF-38534, which is defined as “no RHA”. See “Class H and K, MIL-PRF-38534 Screening” tables for more information.

### CONVERTER DESIGN

The SMHF converters are switching regulators that use a quasi-square wave, single-ended forward converter design with a constant switching frequency of 550 kHz. Isolation between input and output circuits is provided with a transformer in the forward path and a temperature compensated opto-coupler in the feedback control loop. The opto-coupler is radiation hardened and is especially selected for space applications.

For the SMHF dual output models, cross regulation is maintained by tightly coupled output magnetics. Up to 70% of the total output power is available from either output, providing the opposite output is simultaneously carrying 30% of the total output power. Predictable current limit is accomplished by directly monitoring

the output load current and providing a constant current output above the overload point.

### HIGHER POWER DENSITY

The SMHF Series offers a new standard of performance for small size and high power density. At just 0.33 inch high and a total footprint of 1.7 in<sup>2</sup>, this low profile package offers a total power density of up to 30 watts per cubic inch.

### LOW NOISE, HIGH AUDIO REJECTION

The SMHF converter's feed-forward compensation system provides excellent dynamic response and noise rejection. Audio rejection is typically 50 dB. Typical output voltage response for a 50% to 100% step load transient is as low as 1.3% with a 150  $\mu$ S recovery time. Input ripple current is typically 35 mA p-p with output ripple voltage typically 50 mV p-p.

### INHIBIT FUNCTION

SMHF converters provide an inhibit terminal that can be used to disable internal switching, resulting in no output and very low quiescent input current. The converter is inhibited when a logic low ( $\leq 0.8$  – output disabled) is applied to the inhibit pin. The unit is enabled when the pin, which is internally connected to a pull-up resistor, is left unconnected or is connected to an open-collector gate. The open circuit output voltage associated with the inhibit pin is 8.5 to 12 VDC. In the inhibit mode, a maximum of 4 mA must be sunk from the inhibit pin at 28 VDC input.



# SMHF Single and Dual DC/DC Converters

## 28 VOLT INPUT – 15 WATT

### OPERATING CONDITIONS AND CHARACTERISTICS

#### Input Voltage Range

- 16 to 40 VDC continuous
- 50 V for up to 50 msec transient

#### Power Dissipation (Pd)

- 8 W

#### Output Power

- up to 15 watts depending on model

#### Lead Soldering Temperature (10 sec per lead)

- 300°C

#### Storage Temperature Range (Case)

- -65°C to +150°C

#### Case Operating Temperature (Tc)

- -55°C to +125°C full power
- -55°C to +135°C absolute

#### Derating Output Power/Current (Tc)

- Linearly from 100% at 125°C to 0% at 135°C

#### Output Voltage Temperature Coefficient

- 100 ppm /°C typical
- 150 ppm/°C maximum

#### Input to Output Capacitance

- 60 pF typical

#### Current Limit

- 115% of full load typical

#### Isolation

- 100 megohm minimum at 500 VDC
- Any pin to case, except case pin

#### Audio Rejection

- 50 dB typical

#### Conversion Frequency (°55°C to +125°C Tc)

- Free run 550 kHz typical
- 480 kHz min, 620 kHz max

#### Inhibit Pin Voltage (unit enabled)

- 8.5 to 12 V

#### Undervoltage Lockout

- 14 V input typical

### SYNC AND INHIBIT

#### Sync In (500 to 600 kHz)

- Duty cycle 40% to 60%
- Logic low 0.8 V max
- Logic high 4.5 V min, 5 V max
- Referenced to input common
- If not used, connect to input common

#### Inhibit TTL Open Collector

- Logic low (output disabled)
  - Logic low voltage  $\leq 0.8$  V max
  - Inhibit pin current 12 mA max
- Referenced to input common
- Logic high (output enabled)
  - Open collector or unconnected

---

### MECHANICAL AND ENVIRONMENTAL

#### Size (maximum)

Non flanged

1.460 x 1.130 x 0.330 (37.08 x 28.70 x 8.38 mm). See case E1 for dimensions.

Flanged

2.005 x 1.130 x 0.330 (50.93 x 28.70 x 8.38 mm). See case G1 for dimensions.

#### Weight (maximum)

30 grams typical

#### Screening

Space Prototype, Class H, or Class K

Radiation tolerant to Radiation Hardness Assurance (RHA) levels of “-” (O) or “R”, per MIL-STD-38534. Interpoint model numbers use an “O” in the RHA designator position to indicate the “-” (dash) Radiation Hardness Assurance level of MIL-PRF-38534, which is defined as “no RHA”.

See “Class H and K, MIL-PRF-38534 Screening” tables for more information.

Available configurations: OO, HO, HR, KR

# SMHF Single and Dual DC/DC Converters

## 28 VOLT INPUT – 15 WATT

### PIN OUT

Pin	Single Output	Dual Output
1	Inhibit	Inhibit
2	No connection	Positive Output
3	Output Common	Output Common
4	Positive Output	Negative Output
5 <sup>1</sup>	Sync	Sync
6	Case Ground	Case Ground
7	Input Common	Input Common
8	Positive Input	Positive Input

1. If Sync is not used, pin 5 should be connected directly to input common.

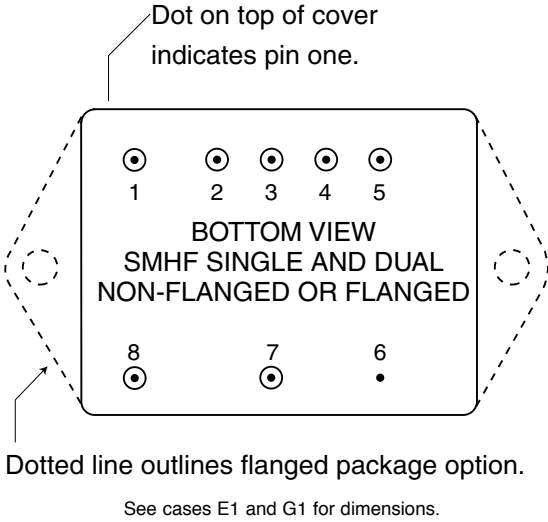
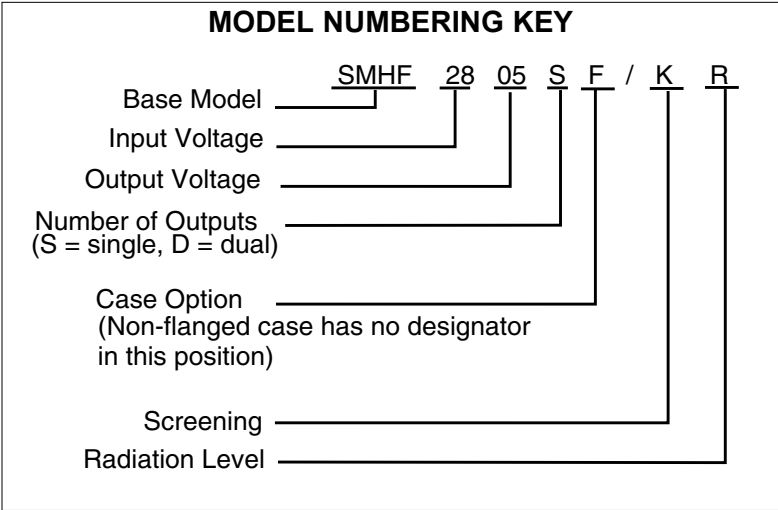

FIGURE 2: PIN OUT

# SMHF Single and Dual DC/DC Converters

## 28 VOLT INPUT – 15 WATT



### SMD NUMBERS

STANDARD MICROCIRCUIT DRAWING (SMD)	SMHF SIMILAR PART
IN PROCESS	SMHF282R5S/HO
5962-0251002HXC	SMHF283R3S/HO
5962-9213902HXC	SMHF2805S/HO
5962-9166402HXC	SMHF2812S/HO
5962-9160102HXC	SMHF2815S/HO
5962-9555902HXC	SMHF2805D/HO
5962-9214402HXC	SMHF2812D/HO
5962-9161402HXC	SMHF2815D/HO

To indicate the flanged case option change the "X" to "Z" in the SMD number. The SMD number shown is for Class H screening, non-flanged, and no Radiation Hardness Assurance (RHA) level. See the SMD for the numbers for other screening and radiation levels. For exact specifications for an SMD product, refer to the SMD drawing. Call your Interpoint representative for status on the SMHF SMD releases which are "in process." SMDs can be downloaded from: <http://www.dscclia.mil/programs/smcr>

### MODEL SELECTION

SMHF28      \_\_\_\_\_      \_\_\_\_\_      \_\_\_\_\_ / \_\_\_\_\_  
 Base model       $V_{out}$  value      number of outputs      case option      screening

Choose one from each of the following rows

$V_{out}$  value      for singles 2.5, 3.3, 5, 12, 15      for duals: 5, 12, 15  
 "R" = decimal point, 3R3 = 3.3VDC

Number of outputs      S (single) or D (dual)

Case option      non-flanged, leave blank    F - flanged

Screening      OO\* - Space prototype, HO, HR, KR

\*Interpoint model numbers use an "O" in the RHA designator position to indicate the "-" (dash) Radiation Hardness Assurance level of MIL-PRF-38534, which is defined as "no RHA"

# SMHF Single and Dual DC/DC Converters

## 28 VOLT INPUT – 15 WATT

Electrical Characteristics: 25°C Tc, 28 VDC Vin, 100% load, radiation level O, unless otherwise specified.

SINGLE OUTPUT MODELS		SMHF282R5S			SMHF283R3S			SMHF2805S			UNITS
PARAMETER	CONDITIONS	MIN	TYP	MAX	MIN	TYP	MAX	MIN	TYP	MAX	
OUTPUT VOLTAGE	TC = 25°C	2.475	2.5	2.525	3.27	3.30	3.33	4.95	5.00	5.05	VDC
OUTPUT CURRENT	VIN = 16 TO 40 VDC	—	—	2.4	—	—	2.4	—	—	2.4	A
OUTPUT POWER	VIN = 16 TO 40 VDC	0	—	6	0	—	8	0	—	12	W
OUTPUT RIPPLE	10 KHZ - 2 MHZ	—	15	50	—	60	160	—	30	80	mV p-p
	TC = -55°C TO +125°C	—	25	50	—	80	240	—	150	240	
LINE REGULATION	VIN = 16 TO 40 VDC	—	5	50	—	5	100	—	5	100	mV
LOAD REGULATION	NO LOAD TO FULL	—	28	50	—	20	50	—	20	50	mV
INPUT VOLTAGE NO LOAD TO FULL	CONTINUOUS	16	28	40	16	28	40	16	28	40	VDC
	TRANSIENT 120 ms <sup>1</sup>	0	—	50	0	—	50	0	—	50	V
INPUT CURRENT	NO LOAD	—	20	40	—	25	65	—	25	40	mA
	INHIBITED	—	6	12	—	5	12	—	5	12	
INPUT RIPPLE CURRENT	10 KHZ - 10 MHZ	—	30	50	—	45	80	—	35	80	mA p-p
	TC = -55°C TO +125°C	—	—	50	—	—	120	—	—	120	
EFFICIENCY	TC = 25°C	65	67	—	68	73	—	73	75	—	%
LOAD FAULT <sup>2</sup>	SHORT CIRCUIT POWER DISSIPATION	—	3	6	—	5	8	—	3.5	8	W
	RECOVERY <sup>1, 3</sup>	—	7.5	30	—	7.5	30	—	7.5	30	ms
STEP LOAD RESPONSE	50% - 100% - 50% TRANSIENT <sup>4</sup>	-200	50	200	-400	150	400	-500	150	500	mV pk
	RECOVERY <sup>3</sup>	—	50	270	—	150	300	—	150	300	μs
STEP LINE RESPONSE <sup>1</sup>	16 - 40 - 16 VDC TRANSIENT <sup>4</sup>	-800	550	800	-800	550	800	-800	550	800	mV pk
	RECOVERY <sup>3</sup>	—	0.8	1.2	—	0.8	1.2	—	0.8	1.2	ms
START-UP 0 TO 28 VDC	DELAY	—	10	20	—	10	25	—	10	25	ms
	OVERSHOOT <sup>1, 4</sup>	—	—	250	—	200	300	—	100	600	mV pk
CAPACITIVE LOAD	TC = 25°C	—	—	—	—	—	300	—	—	300	μF

### Notes

1. Guaranteed by design, not tested.

2. Indefinite short circuit protection not guaranteed above 125°C (case)

3. Recovery time is measured from application of the transient to the point at which Vout is within regulation.

4. Step transition time >10μs.

# SMHF Single and Dual DC/DC Converters

## 28 VOLT INPUT – 15 WATT

Electrical Characteristics: 25°C Tc, 28 VDC Vin, 100% load, radiation level O, unless otherwise specified.

SINGLE OUTPUT MODELS		SMHF2812S			SMHF2815S			UNITS
PARAMETER	CONDITIONS	MIN	TYP	MAX	MIN	TYP	MAX	
OUTPUT VOLTAGE	TC = 25°C	11.88	12.00	12.12	14.85	15.00	15.15	VDC
OUTPUT CURRENT	VIN = 16 TO 40 VDC	—	—	1.25	—	—	1.00	A
OUTPUT POWER	VIN = 16 TO 40 VDC	0	—	15	0	—	15	W
OUTPUT RIPPLE	10 KHZ - 2 MHZ	—	60	150	—	60	175	mV p-p
	TC = -55°C TO +125°C	—	50	200	—	100	260	
LINE REGULATION	VIN = 16 TO 40 VDC	—	5	100	—	5	100	mV
LOAD REGULATION	NO LOAD TO FULL	—	20	50	—	20	50	mV
INPUT VOLTAGE NO LOAD TO FULL	CONTINUOUS	16	28	40	16	28	40	VDC
	TRANSIENT 120 ms <sup>1</sup>	0	—	50	0	—	50	V
INPUT CURRENT	NO LOAD	—	25	55	—	25	62	mA
	INHIBITED	—	5	12	—	5	12	
INPUT RIPPLE CURRENT	10 KHZ - 10 MHZ	—	35	80	—	35	80	mA p-p
	TC = -55°C TO +125°C	—	—	120	—	—	120	
EFFICIENCY	TC = 25°C	76	79	—	78	80	—	%
LOAD FAULT <sup>2</sup>	SHORT CIRCUIT POWER DISSIPATION	—	3.5	8	—	3.5	8	W
	RECOVERY <sup>1, 3</sup>	—	7.5	30	—	7.5	30	ms
STEP LOAD RESPONSE	50% - 100% - 50% TRANSIENT <sup>4</sup>	-700	150	700	-800	200	800	mV pk
	RECOVERY <sup>3</sup>	—	150	1000	—	600	1200	μs
STEP LINE RESPONSE <sup>1</sup>	16 - 40 - 16 VDC TRANSIENT <sup>4</sup>	-800	550	800	-800	550	800	mV pk
	RECOVERY <sup>3</sup>	—	0.8	1.2	—	0.8	1.2	ms
START-UP 0 TO 28 VDC	DELAY	—	10	25	—	10	25	ms
	OVERSHOOT <sup>1, 4</sup>	—	200	1200	—	200	1500	mV pk
CAPACITIVE LOAD	TC = 25°C	—	—	100	—	—	100	μF

### Notes

1. **Guaranteed by design, not tested.**

2. Indefinite short circuit protection not guaranteed above 125°C (case)

3. Recovery time is measured from application of the transient to the point at which Vout is within regulation.

4. Step transition time >10μs.

# SMHF Single and Dual DC/DC Converters

## 28 VOLT INPUT – 15 WATT

Electrical Characteristics: 25°C Tc, 28 VDC Vin, 100% load, radiation level O, unless otherwise specified.

DUAL OUTPUT MODELS		SMHF2805D			SMHF2812D			SMHF2815D			UNITS	
PARAMETER	CONDITIONS	MIN	TYP	MAX	MIN	TYP	MAX	MIN	TYP	MAX		
OUTPUT VOLTAGE	+ V <sub>OUT</sub>	4.95	5.00	5.05	11.88	12.00	12.12	14.85	15.00	15.15	VDC	
	- V <sub>OUT</sub>	4.92	5.00	5.08	11.82	12.00	12.18	14.78	15.00	15.23		
OUTPUT CURRENT <sup>2</sup>	V <sub>IN</sub> = 16 TO 40 VDC	–	±1.2	1.68	–	±0.625	0.875	–	±0.5	0.7	A	
OUTPUT POWER <sup>2</sup>	V <sub>IN</sub> = 16 TO 40 VDC	–	–	12	–	–	15	–	–	15	W	
OUTPUT RIPPLE ± V <sub>OUT</sub>	10 KHZ - 2 MHZ	–	60	160	–	70	175	–	70	175	mV p-p	
	TC = -55°C TO +125°C	–	100	240	–	100	275	–	100	275		
LINE REGULATION V <sub>IN</sub> = 16 TO 40 VDC	BALANCED LOAD	+ V <sub>OUT</sub>	–	5	50	–	5	50	–	5	50	mV
		- V <sub>OUT</sub>	–	–	100	–	–	100	–	–	100	
LOAD REGULATION NO LOAD TO FULL	BALANCED LOAD	+ V <sub>OUT</sub>	–	20	50	–	20	50	–	20	50	mV
		- V <sub>OUT</sub>	–	–	150	–	–	150	–	–	150	
CROSS REGULATION <sup>3</sup>	EFFECT ON - V <sub>OUT</sub>	–	6	7.5	–	3	6	–	3	6	%	
INPUT VOLTAGE NO LOAD TO FULL	CONTINUOUS	16	28	40	16	28	40	16	28	40	VDC	
	TRANSIENT 50 ms <sup>1</sup>	–	–	50	–	–	50	–	–	50	V	
INPUT CURRENT	NO LOAD	–	20	50	–	25	50	–	25	50	mA	
	INHIBITED	–	6	12	–	5	12	–	5	12		
INPUT RIPPLE CURRENT	10 KHZ - 10 MHZ	–	30	80	–	40	80	–	40	80	mA p-p	
	TC = -55°C TO +125°C	–	60	120	–	55	120	–	55	120		
EFFICIENCY		75	77	–	76	81	–	76	82	–	%	
LOAD FAULT <sup>4</sup>	SHORT CIRCUIT POWER DISSIPATION	–	3	6	–	3	6	–	3	6	W	
	RECOVERY <sup>1, 5</sup>	–	7.5	30	–	7.5	50	–	7.5	50	ms	
STEP LOAD RESPONSE <sup>6</sup> BALANCED LOADS	50% - 100% - 50% TRANSIENT <sup>7</sup>	+ V <sub>OUT</sub>	-600	200	600	-600	300	600	-600	300	600	mV pk
		- V <sub>OUT</sub>	-600	150	600	-600	100	600	-600	100	600	mV pk
	RECOVERY <sup>5</sup>	–	150	500	–	200	500	–	200	600	μs	
STEP LINE RESPONSE <sup>1</sup> ± V <sub>OUT</sub>	16 - 40 -16 VDC TRANSIENT <sup>7</sup>	-800	600	800	-750	550	750	-750	550	750	mV pk	
	RECOVERY <sup>5</sup>	–	0.8	1.2	–	0.8	1.2	–	0.8	1.2	ms	
START-UP 0 TO 40 V	DELAY	–	12	30	–	12	25	–	12	25	ms	
	OVERSHOOT <sup>1, 7</sup>	0	100	500	0	200	500	0	200	500	mV pk	
CAPACITIVE LOAD	TC = 25°C	–	–	47	–	–	10	–	–	10	μF	

### Notes

**1. Guaranteed by design, not tested.**

2. Up to 70% of the total output power is available from either output providing the opposite output is simultaneously carrying 30% of the total output power. Each output must carry a minimum of 30% of the total output power in order to maintain regulation on the negative output.

3. Effect on -V<sub>out</sub> for the following conditions, percentages are of total power:  
+P<sub>o</sub> = 50% to 10% and -P<sub>o</sub> = 50%, +P<sub>o</sub> = 50% and -P<sub>o</sub> = 50% to 10%  
and from +P<sub>o</sub> = 70%/ -P<sub>o</sub> = 30% to +P<sub>o</sub> = 30%/ -P<sub>o</sub> = 70%  
all conditions are referenced to the balanced loads condition: 50%/50%

4. Indefinite short circuit protection not guaranteed above 125°C (case)

5. Recovery time is measured from application of the transient to point at which V<sub>out</sub> is within regulation.

6. Response of either output with the opposite output held at half of the total output power.

7. Step transition time >10μs.



# SMHF Single and Dual DC/DC Converters

## 28 VOLT INPUT – 15 WATT

Typical Performance Curves: 25°C Tc, 28 VDC Vin, 100% load, free run, unless otherwise specified.

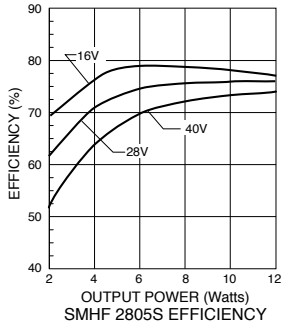

FIGURE 3

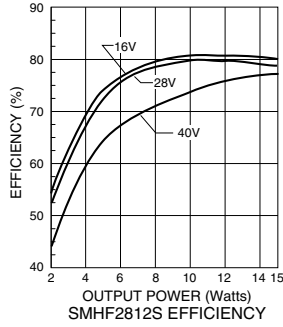

FIGURE 4

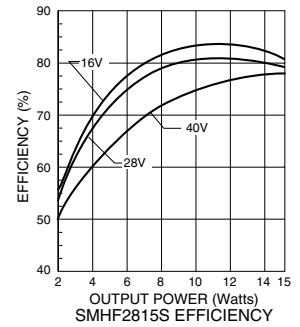

FIGURE 5

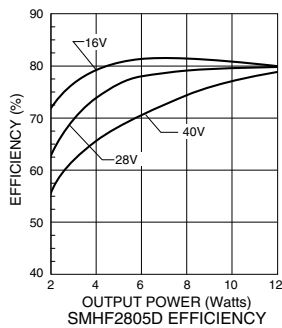

FIGURE 6

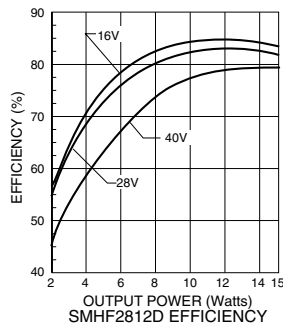

FIGURE 7

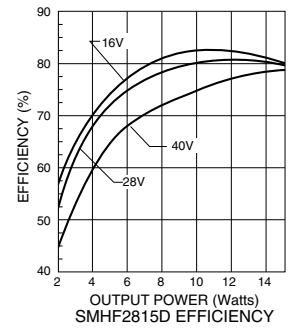

FIGURE 8

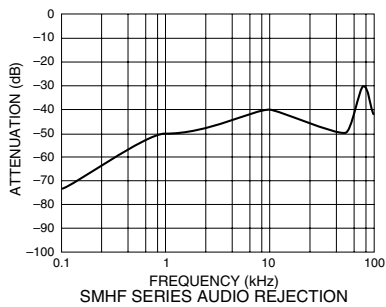

FIGURE 9

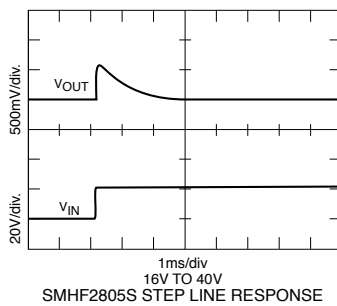

FIGURE 10

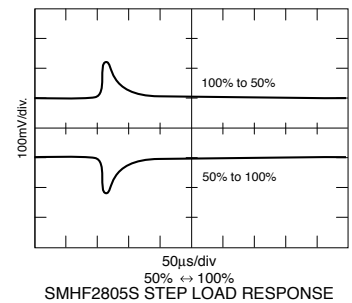

FIGURE 11

# SMHF Single and Dual DC/DC Converters

## 28 VOLT INPUT – 15 WATT

Typical Performance Curves: 25°C Tc, 28 VDC Vin, 100% load, free run, unless otherwise specified.

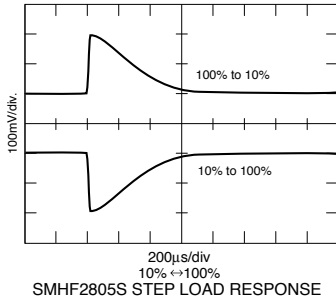

FIGURE 12

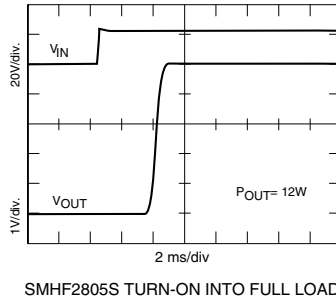

FIGURE 13

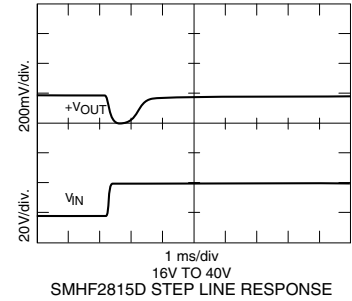

FIGURE 14

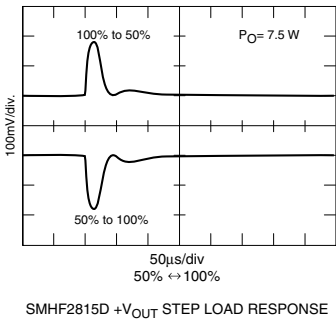

FIGURE 15

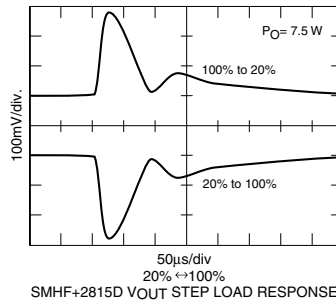

FIGURE 16

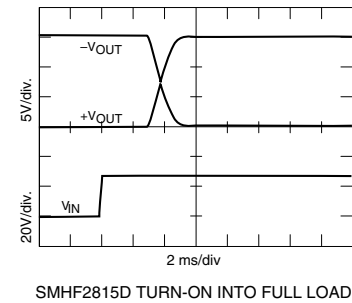

FIGURE 17

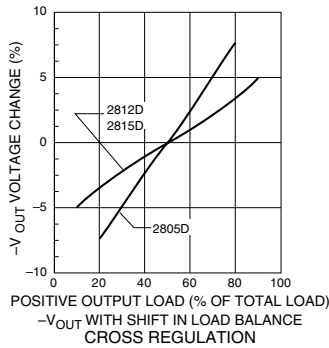

FIGURE 18

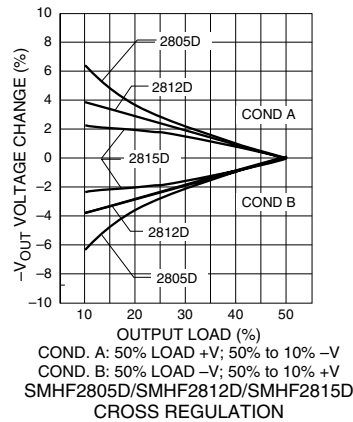

FIGURE 19

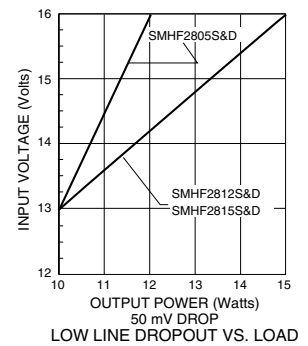
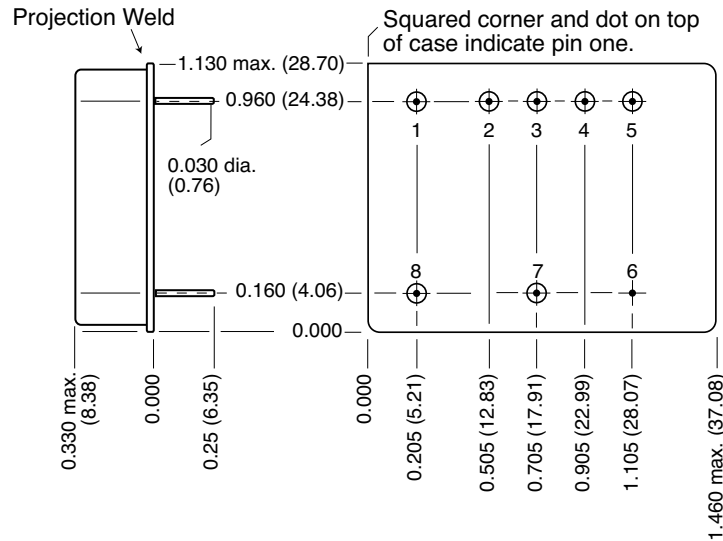

FIGURE 20

# SMHF Single and Dual DC/DC Converter Cases

## 28 VOLT INPUT – 15 WATT

### BOTTOM VIEW CASE E1



#### Case dimensions in inches (mm)

Tolerance  $\pm 0.005$  (0.13) for three decimal places  
 $\pm 0.01$  (0.3) for two decimal places  
 unless otherwise specified

#### CAUTION

Heat from reflow or wave soldering may damage the device.  
 Solder pins individually with heat application not exceeding 300°C for 10 seconds per pin.

#### Materials

Header Cold Rolled Steel/Nickel/Gold  
 Cover Kovar/Nickel  
 Pins #52 alloy/Gold compression glass seal

Case E1, Rev C, 20061221

Please refer to the numerical dimensions for accuracy. All information is believed to be accurate, but no responsibility is assumed for errors or omissions. Interpoint reserves the right to make changes in products or specifications without notice.

Copyright © 1999-2006 Interpoint Corp. All rights reserved.

FIGURE 21: CASE E1



# SMHF Single and Dual DC/DC Converters

## 28 VOLT INPUT – 15 WATT

### CLASS H AND K, MIL-PRF-38534 ELEMENT EVALUATION

COMPONENT-LEVEL TEST PERFORMED	SPACE PROTOTYPE (O) NON-QML <sup>1</sup>		CLASS H QML		CLASS K QML	
	M/S <sup>2</sup>	P <sup>3</sup>	M/S <sup>2</sup>	P <sup>3</sup>	M/S <sup>2</sup>	P <sup>3</sup>
Element Electrical	yes	no	yes	yes	yes	yes
Element Visual	no	no	yes	yes	yes	yes
Internal Visual	no	N/A	yes	N/A	yes	N/A
Temperature Cycling	no	no	no	no	yes	yes
Constant Acceleration	no	no	no	no	yes	yes
Interim Electrical	no	N/A	no	N/A	yes	N/A
Burn-in	no	N/A	no	N/A	yes	N/A
Post Burn-in Electrical	no	N/A	no	N/A	yes	N/A
Steady State Life	no	N/A	no	N/A	yes	N/A
Voltage Conditioning Aging	N/A	no	N/A	no	N/A	yes
Visual Inspection	no	no	N/A	no	N/A	yes
Final Electrical	no	no	yes	yes	yes	yes
Wire Bond Evaluation <sup>4</sup>	no	no	yes	yes	yes	yes
SEM	no	N/A	no	N/A	yes	N/A
SLAM™/C-SAM: Input capacitors only (Add'l test, not req. by H or K)	no	no	no	yes	no	yes

## Notes:

1. Non-QML products do not meet all of the requirements of MIL-PRF-38534.
2. M/S = Active components (Microcircuit and Semiconductor Die)
3. P = Passive components
4. Not applicable to EMI filters that have no wirebonds.

## Definitions:

Element Evaluation: Component testing/screening per MIL-STD-883 as determined by MIL-PRF-38534

SEM: Scanning Electron Microscopy

SLAM™: Scanning Laser Acoustic Microscopy

C-SAM: C - Mode Scanning Acoustic Microscopy

# SMHF Single and Dual DC/DC Converters

## 28 VOLT INPUT – 15 WATT

### CLASS H AND K, MIL-PRF-38534 ENVIRONMENTAL SCREENING

END ITEM-LEVEL TEST PERFORMED	SPACE PROTOTYPE (O) NON-QML <sup>1</sup>	CLASS H QML	CLASS K QML
Non-destruct bond pull <sup>2</sup> Method 2023	no	yes <sup>3</sup>	yes
Pre-cap Inspection Method 2017, 2032	yes	yes	yes
Temperature Cycle (10 times) Method 1010, Cond. C, -65°C to 150°C, ambient	yes	yes	yes
Constant Acceleration Method 2001, 3000 g	yes	yes	yes
PIND Test Method 2020, Cond. A	no	yes <sup>3</sup>	yes
Pre burn-in test	yes	yes	yes
Burn-in Method 1015, 125°C case, typical			
96 hours	yes	no	no
160 hours	no	yes	no
2 x 160 hours (includes mid-BI test)	no	no	yes
Final Electrical Test MIL-PRF-38534 Group A, Subgroups 1 through 6 -55°C, +25°C, +125°C case	yes	yes	yes
Radiography Method 2012	N/A	N/A	N/A
Post Radiography Electrical Test Room temperature	N/A	N/A	yes <sup>3</sup>
Hermeticity Test Fine Leak, Method 1014, Cond. A Gross Leak, Method 1014, Cond. C	yes yes	yes yes	yes yes
Final visual inspection Method 2009	yes	yes	yes

Test methods are referenced to MIL-STD-883 as determined by MIL-PRF-38534.

Notes:

1. Space Prototype (O), non-QML products, do not meet all of the requirements of MIL-PRF-38534.
2. Not applicable to EMI filters that have no wirebonds.
3. Not required by DSCC but performed to assure product quality.

# SMHF Single and Dual DC/DC Converters

## 28 VOLT INPUT – 15 WATT

### CLASS H AND K, MIL-PRF-38534 RADIATION ASSURANCE

RADIATION HARDNESS ASSURANCE LEVELS	ENVIRONMENTAL SCREENING LEVELS		
	SPACE PROTOTYPE (O) NON-QML <sup>3</sup>	CLASS H QML	CLASS K QML
<b>O<sup>2</sup></b> : Standard, no radiation guarantee	OO	HO	N/A
<b>P<sup>5</sup></b> : Radiation tolerant–Tested lots up to 30 K Rads (Si) total dose SEU guarantee up to 40 MeV	N/A	HP <sup>4</sup>	KP <sup>4</sup>
<b>R<sup>5</sup></b> : Radiation tolerant–Tested lots up to 100 K Rads (Si) total dose SEU guarantee up to 40 MeV	N/A	HR <sup>4</sup>	KR <sup>4</sup>
<b>F<sup>5</sup></b> : [SMRT only] Radiation tolerant–Tested lots up to 300 K Rads (Si) total dose SEU guarantee up to 60 MeV	N/A	N/A	KF <sup>4</sup>
<b>H<sup>1,5</sup></b> : Radiation tolerant–Tested lots up to 1,000 K Rads (Si) total dose	N/A	HH <sup>4</sup>	KH <sup>4</sup>

Notes:

- Our EMI filters are designed exclusively with passive components providing maximum tolerance for space environment requirements.
- Interpoint model numbers use an "O" in the RHA designator position to indicate the "-" (dash) Radiation Hardness Assurance level of MIL-PRF-38534, which is defined as "no RHA".
- Space Prototype (O), non-QML, products do not meet all of the requirements of MIL-PRF-38534.
- Redmond site, Interpoint, has a Radiation Hardness assurance plan on file with DSCC. Our SMD products with RHA "P", "R," "F" and "H" code meet DSCC requirements.
- Space converters are available with Radiation Hardness Assurance (RHA) levels of "O" and "R" with the following exceptions:  
SMRT28xxx is only available with Radiation Hardness Assurance (RHA) levels of "O" "P", "R" and "F".  
SMHP120xxx is only available with Radiation Hardness Assurance (RHA) level of "O".  
Space filters are only available with Radiation Hardness Assurance (RHA) levels of "O" and "H".