

**PLEASE CHECK WWW.MOLEX.COM FOR LATEST PART INFORMATION**

**Part Number:** **0351820290**  
**Status:** **Active**  
**Description:** 1.78mm (.070") Tab, 8.70mm (.343") Pitch Wire-to-Wire Male Housing TPA™, 2 Circuits, Vertical

**Documents:**

[Drawing \(PDF\)](#) [Product Specification PS-35182-003 \(PDF\)](#)  
[Product Specification PS-35180-002 \(PDF\)](#) [RoHS Certificate of Compliance \(PDF\)](#)

**General**

Product Family	Accessories
Series	<a href="#">35182</a>
Component Type	Retainer
Product Name	TPA™ - Term Pos Assurance

**Physical**

Circuits (Loaded)	2
Color - Resin	Natural
Lock to Mating Part	Yes
Material - Resin	Nylon
Number of Rows	1
Packaging Type	Bag
Temperature Range - Operating	-40°C to +120°C

**Material Info**

**Reference - Drawing Numbers**

Product Specification	PS-35180-002, PS-35182-003
Sales Drawing	SD-35182-029*

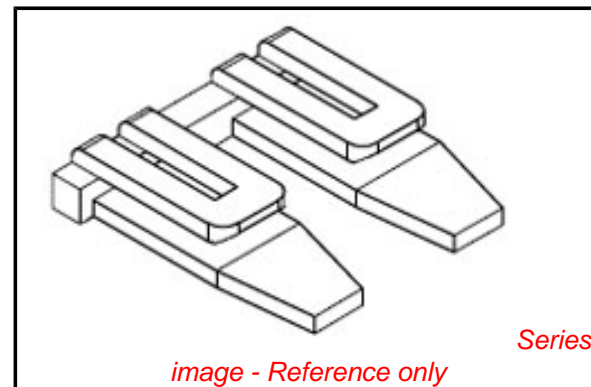

*image - Reference only*

**EU RoHS**

**ELV and RoHS  
Compliant**  
**REACH SVHC  
Contains SVHC: No**  
**Halogen-Free  
Status**

**China RoHS**



**Need more information on product  
environmental compliance?**

Email [productcompliance@molex.com](mailto:productcompliance@molex.com)  
 For a multiple part number RoHS Certificate of Compliance, [click here](#)

Please visit the [Contact Us](#) section for any non-product compliance questions.

**Search Parts in this Series**

[35182Series](#)

**Use With**

[35180 Wire-to-Wire Male Housing](#)

ENG. NO.  
SD\_35182-029\*

EDP NO.

SIMILAR ITEM

PROJECT NO.  
.070 MULTI CONN'

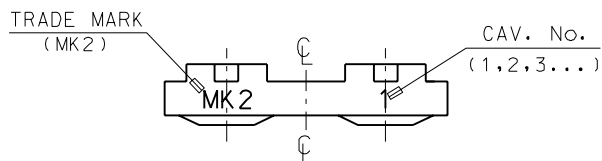
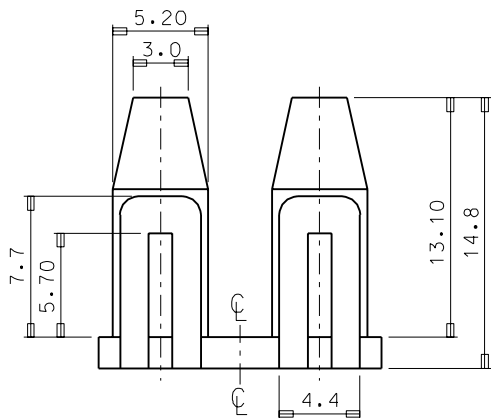
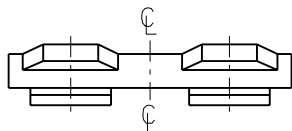

NOTES

- MATERIAL : NYLON 66 (UL94V-2)
- COLOR : 35182-0290 (NATURAL)  
35182-0292 (RED)  
35182-0293 (YELLOW)  
35182-0294 (BLUE)
- MATCHED HOUSING : 35180-040\*

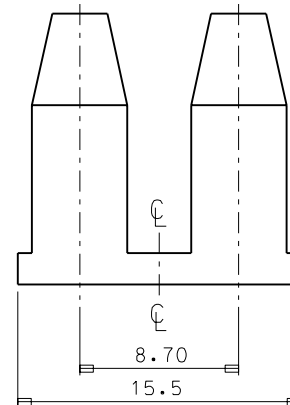
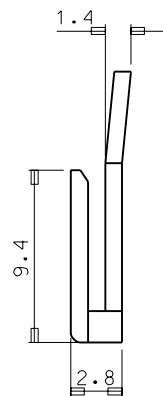
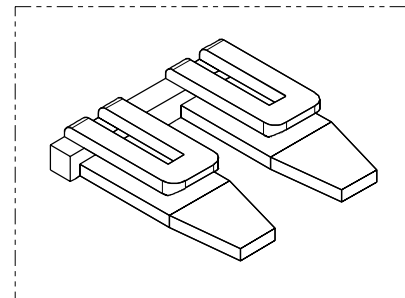

				MATERIAL SEE NOTES		molex MOLEX-KOREA CO.,LTD.	
				GENERAL TOLERANCE		DRAWN BY J. S. KANG	
				DIMENSION : $\pm 0.3$		CHK'D BY	
				ANGLE : $\pm 1^\circ$		APP'D BY	
				DIMENSION CLASSIFICATION		SCALE 4/1	
				▽ : CRITICAL ▼ : MAJOR		TITLE :	
				() : REFERENCE		.070 MULTI MALE HOUSING T.P. A-2P	
A	NEW RELEASED	PDR 94-044	95 9.28	ASS'Y PART		SHEET 1 of 1	
LTR	REVISION RECORD	ECN	DATE	DESCRIPTION ENG. NO.		REV A	
REVISE ONLY ON CAD SYSTEM				---		ENG. NO. SD 35182-029*	