



High Performance BGA Cooling Solutions w/ Thermal Tape Attachment

ATS PART # ATS-54450D-C2-R0

Features & Benefits

- » High aspect ratio, straight fin heat sinks that are ideal for compact PCB environments
- » Designed specifically for BGAs and other surface mount packages
- » Comes preassembled with high performance thermal interface material

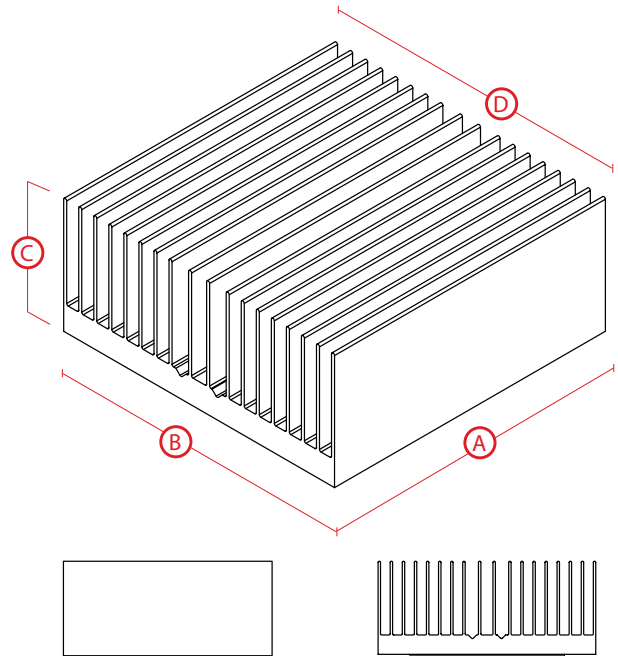

**Image above is for illustration purposes only.*

Thermal Performance

AIR VELOCITY		THERMAL RESISTANCE	
FT/MIN	M/S	°C/W (UNDUCTED FLOW)	°C/W (DUCTED FLOW)
200	1.0	8.4	2.9
300	1.5	5.4	
400	2.0	4.3	
500	2.5	3.7	
600	3.0	3.3	
700	3.5	3.1	
800	4.0	2.8	

Product Details

DIMENSION A	DIMENSION B	DIMENSION C	DIMENSION D	INTERFACE MATERIAL	FINISH
45 mm	45 mm	9.5 mm	45 mm	SAINT-GOBAIN C675	BLACK-ANODIZED

NOTES:

- 1) Dimension C = heat sink height from bottom of the base to the top of the fin field.
- 2) Thermal performance data are provided for reference only. Actual performance may vary by application.
- 3) ATS reserves the right to update or change its products without notice to improve the design or performance.
- 4) Contact ATS to learn about custom options available.



ATS ADVANCED THERMAL SOLUTIONS, INC.
Innovations in Thermal Management®

For more information, to find a distributor or to place an order, visit www.qats.com or call: 781.769.2800 (North America); +31 (0) 3569 84715 (Europe).