

PLEASE CHECK WWW.MOLEX.COM FOR LATEST PART INFORMATION

Part Number: [0310721040](#)
Status: **Active**
Overview: H-DAC™ 64 Single Row
Description: 2.54mm (.100") H-DAC 64™, 5 Way Male Housing Assembly, Single-Row, Polarization A

Documents:

[Drawing \(PDF\)](#) [Product Specification PS-31067-0001 \(PDF\)](#)
[Application Specification \(PDF\)](#) [RoHS Certificate of Compliance \(PDF\)](#)

General

| | |
|----------------|--------------------------------------|
| Product Family | Crimp Housings |
| Series | 31072 |
| Comments | Polarization Option A, Black |
| Overview | H-DAC™ 64 Single Row |
| Product Name | H-DAC 64™ |

Physical

| | |
|-------------------------------|---------------------------------|
| Circuits (maximum) | 5 |
| Circuits Detail | 5 |
| Color - Resin | Black |
| Gender | Male |
| Glow-Wire Compliant | No |
| Keying to Mating Part | None |
| Lock to Mating Part | Yes |
| Material - Resin | Modified Polystyrene, Polyester |
| Number of Rows | 1 |
| Packaging Type | Bag |
| Panel Mount | No |
| Pitch - Mating Interface (in) | 0.100 In |
| Pitch - Mating Interface (mm) | 2.54 mm |
| Pitch - Term. Interface (in) | 0.100 In |
| Pitch - Term. Interface (mm) | 2.54 mm |
| Polarized to Mating Part | Yes |
| Ports | 1 |
| Stackable | No |
| Temperature Range - Operating | -40°C to +100°C |

Electrical

| | |
|-------------------------------|---------|
| Current - Maximum per Contact | 11A, 9A |
|-------------------------------|---------|

Material Info

Reference - Drawing Numbers

| | |
|-----------------------|---------------|
| Product Specification | PS-31067-0001 |
| Sales Drawing | SD-31110-003 |

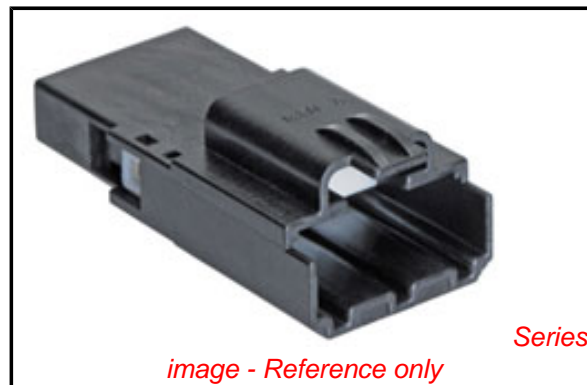

image - Reference only

EU RoHS

ELV and RoHS Compliant
REACH SVHC Contains SVHC: No
Halogen-Free Status
Halogen-Free

China RoHS



Need more information on product environmental compliance?

Email productcompliance@molex.com
 For a multiple part number RoHS Certificate of Compliance, [click here](#)

Please visit the [Contact Us](#) section for any non-product compliance questions.

Search Parts in this Series

[31072Series](#)

Mates With

H-DAC 64™, 5 Way Receptacle Assembly
[310721010](#)

Use With

See Product Spec

3 WAY MALE HOUSING ASSEMBLY
WITHOUT XMAS TREE
(VIEWED FROM MATE SIDE)

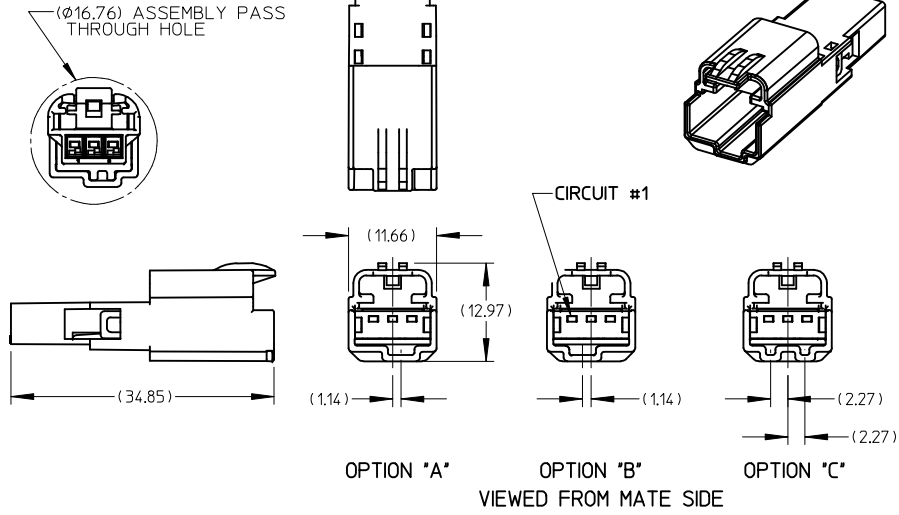

5 WAY MALE HOUSING ASSEMBLY
WITHOUT XMAS TREE
(VIEWED FROM MATE SIDE)

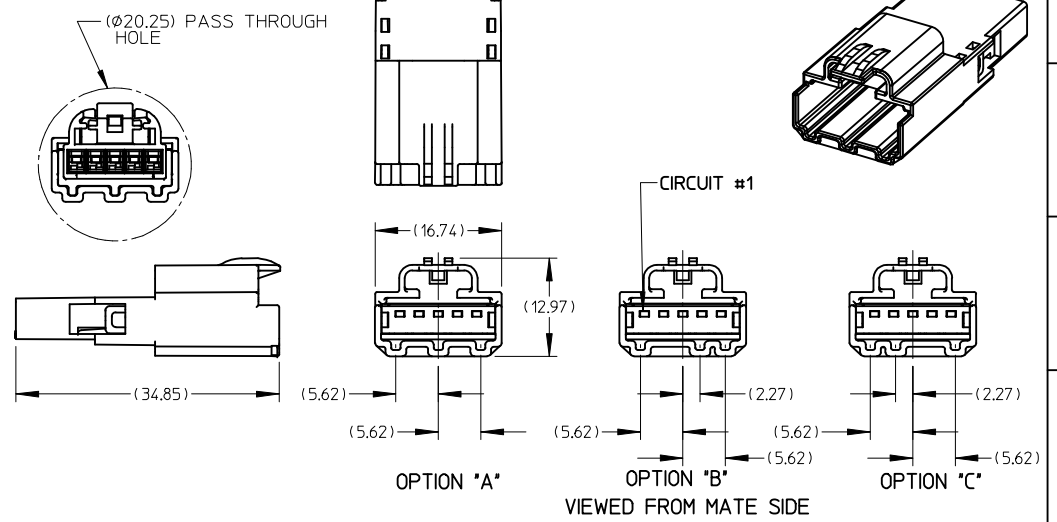

4 WAY MALE HOUSING ASSEMBLY
WITHOUT XMAS TREE
(VIEWED FROM MATE SIDE)

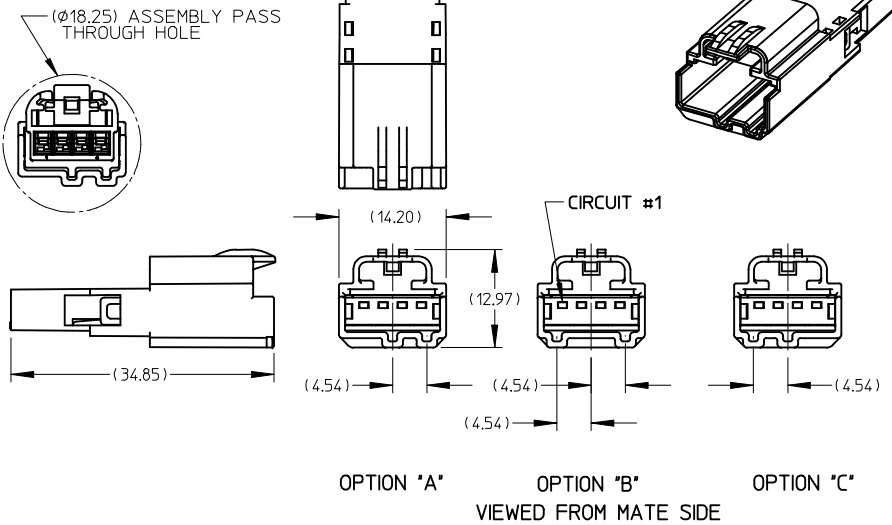

6 WAY MALE HOUSING ASSEMBLY
WITHOUT XMAS TREE
(VIEWED FROM MATE SIDE)

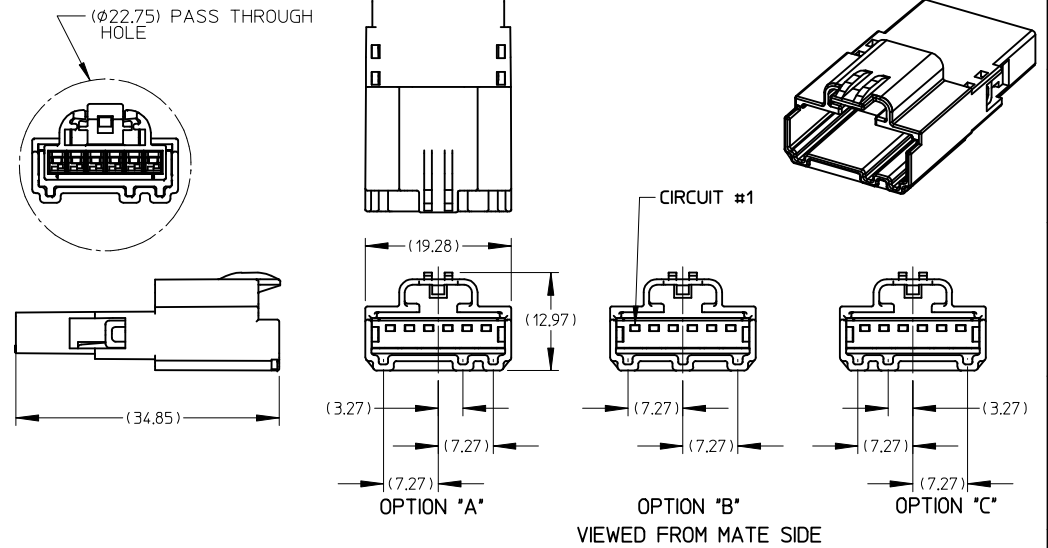

NOTES:

1. MATERIAL: HOUSING: SPS GLASS FILLED, COLOR SEE CHART.
TPA: PBT.
2. PRODUCT SPECIFICATION: PS-31067-0001.
3. PACKAGING SPECIFICATION: DRAWING PK-31301-067.
4. MATES WITH: SEE SALES DRAWINGS SD-31109-003.

EC NO: UAU2009-1155
DRWN: THERUF02009/05/12
CHK: TANGELI2009/05/14
APPR: MKNACK 2009/05/14

| REV | DESCRIPTION |
|-----|-------------|
| E1 | |

| QUALITY SYMBOLS | GENERAL TOLERANCES (UNLESS SPECIFIED) | |
|-----------------|---------------------------------------|-------|
| | mm | INCH |
| ▽-0 | 4 PLACES ± --- | ± --- |
| | 3 PLACES ± --- | ± --- |
| | 2 PLACES ± 0.13 | ± --- |
| | 1 PLACE ± 0.25 | ± --- |
| ∇-0 | ANGULAR ± 1/2 ° | |

DRAFT WHERE APPLICABLE
MUST REMAIN
WITHIN DIMENSIONS

| | |
|-------------------------|---------------------|
| SCALE 2:1 | DESIGN UNITS METRIC |
| DIMENSION STYLE MM ONLY | |
| DRAWN BY | DATE |
| DEMOE | 01/04/04 |
| CHECKED BY | DATE |
| APPROVED BY | DATE |

THIRD ANGLE PROJECTION

REVISE ON CAD ONLY

MALE ASSEMBLY
CHARTED SALES DRAWING

MOLEX MOLEX INCORPORATED

| | | |
|---------------------------|------------------------------|---------------------|
| MATERIAL NO. SEE CHART | DOCUMENT NO. SD-31110-003 | SHEET NO. 1 OF 3 |
|---------------------------|------------------------------|---------------------|

THIS DRAWING CONTAINS INFORMATION THAT IS PROPRIETARY TO MOLEX INCORPORATED AND SHOULD NOT BE USED WITHOUT WRITTEN PERMISSION

3 WAY MALE HOUSING ASSEMBLY WITH XMAS TREE (VIEWED FROM MATE SIDE)

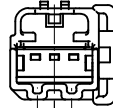
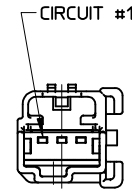
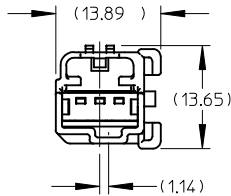
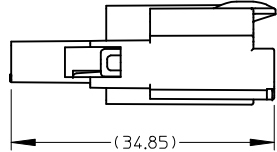
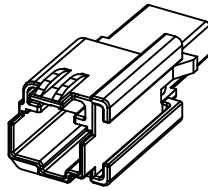
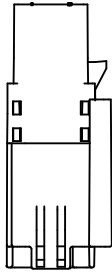

OPTION "A"

OPTION "B" VIEWED FROM MATE SIDE

OPTION "C"

(13.89)
(13.65)
(1.14)
(1.14)
(2.27)
(2.27)

5 WAY MALE HOUSING ASSEMBLY WITH XMAS TREE (VIEWED FROM MATE SIDE)

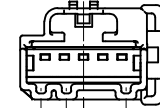
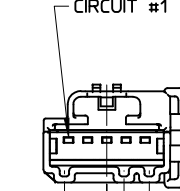
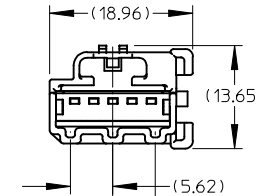
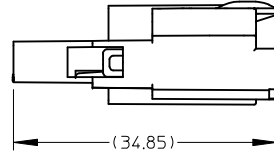
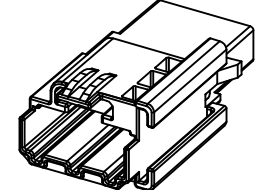
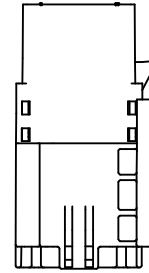

OPTION "A"

OPTION "B" VIEWED FROM MATE SIDE

OPTION "C"

(18.96)
(13.65)
(5.62)
(5.62)
(2.27)
(2.27)
(5.62)
(5.62)

5 WAY MALE HOUSING ASSEMBLY WITH XMAS TREE

4 WAY MALE HOUSING ASSEMBLY WITH XMAS TREE (VIEWED FROM MATE SIDE)

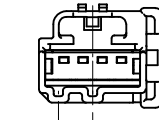
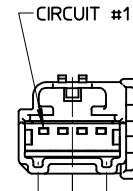
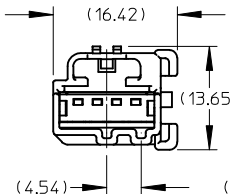
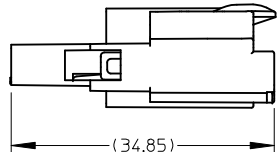
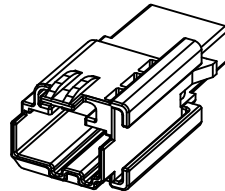
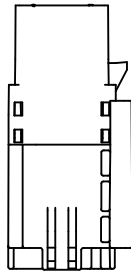

OPTION "A"

OPTION "B" VIEWED FROM MATE SIDE

OPTION "C"

(16.42)
(13.65)
(4.54)
(4.54)
(4.54)
(4.54)

4 WAY MALE HOUSING ASSEMBLY WITH XMAS TREE

6 WAY MALE HOUSING ASSEMBLY WITH XMAS TREE (VIEWED FROM MATE SIDE)

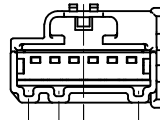
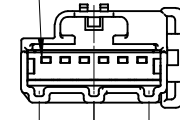
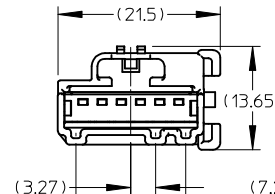
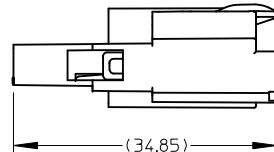
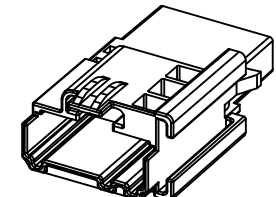
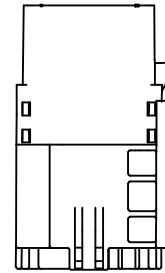

OPTION "A"

OPTION "B" VIEWED FROM MATE SIDE

OPTION "C"

(21.5)
(13.65)
(3.27)
(7.27)
(7.27)
(7.27)
(7.27)
(7.27)

6 WAY MALE HOUSING ASSEMBLY WITH XMAS TREE

EC NO: UAU2009-1155
DRWN: THERFURT009/05/12
CHKD: TSMITH 2009/05/14
APPR: TANGELLO2009/05/14

| QUALITY SYMBOLS | GENERAL TOLERANCES (UNLESS SPECIFIED) | |
|-----------------|---------------------------------------|-------|
| ▽ = 0 | mm | INCH |
| | 4 PLACES ± --- | ± --- |
| ▽C = 0 | 3 PLACES ± --- | ± --- |
| | 2 PLACES ± 0.13 | ± --- |
| | 1 PLACE ± 0.25 | ± --- |
| | ANGULAR ± 1/2° | |

DRAFT WHERE APPLICABLE
MUST REMAIN WITHIN DIMENSIONS

SCALE 2:1
DESIGN UNITS METRIC
DIMENSION STYLE MM ONLY
DRAWN BY DATE
DEMEO 01/04/04
CHECKED BY DATE
APPROVED BY DATE

THIRD ANGLE PROJECTION
REVISE ON CAD ONLY
TITLE
MALE ASSEMBLY CHARTED SALES DRAWING
Molex MOLEX INCORPORATED
MATERIAL NO. ENTER-PART
DOCUMENT NO. SD-3110-003
SHEET NO. 2 OF 3

BILL OF MATERIALS

BILL OF MATERIALS

| ASSEMBLY PART NUMBER | DESCRIPTION | XMAS TREE ATTACHMENT FEATURE | PART NUMBER | DESCRIPTION | COLOR |
|----------------------|--------------------------------------|------------------------------|-------------|--------------|-----------------|
| 31067-1040 | 3 WAY MALE ASSEMBLY POLARIZATION "A" | NO | 31112-0030 | MALE HOUSING | BLACK |
| | | | 31114-0030 | TPA | NATURAL (WHITE) |
| 31067-1041 | 3 WAY MALE ASSEMBLY POLARIZATION "B" | NO | 31112-0031 | MALE HOUSING | GRAY |
| | | | 31114-0030 | TPA | NATURAL (WHITE) |
| 31067-1042 | 3 WAY MALE ASSEMBLY POLARIZATION "C" | NO | 31112-0032 | MALE HOUSING | BROWN |
| | | | 31114-0030 | TPA | NATURAL (WHITE) |
| 31067-1070 | 3 WAY MALE ASSEMBLY POLARIZATION "A" | YES | 31112-1030 | MALE HOUSING | BLACK |
| | | | 31114-0030 | TPA | NATURAL (WHITE) |
| 31067-1071 | 3 WAY MALE ASSEMBLY POLARIZATION "B" | YES | 31112-1031 | MALE HOUSING | GRAY |
| | | | 31114-0030 | TPA | NATURAL (WHITE) |
| 31067-1072 | 3 WAY MALE ASSEMBLY POLARIZATION "C" | YES | 31112-1032 | MALE HOUSING | BROWN |
| | | | 31114-0030 | TPA | NATURAL (WHITE) |
| 31068-1040 | 4 WAY MALE ASSEMBLY POLARIZATION "A" | NO | 31166-0040 | MALE HOUSING | BLACK |
| | | | 31167-0040 | TPA | NATURAL (WHITE) |
| 31068-1041 | 4 WAY MALE ASSEMBLY POLARIZATION "B" | NO | 31166-0031 | MALE HOUSING | GRAY |
| | | | 31167-0040 | TPA | NATURAL (WHITE) |
| 31068-1042 | 4 WAY MALE ASSEMBLY POLARIZATION "C" | NO | 31166-0032 | MALE HOUSING | BROWN |
| | | | 31167-0040 | TPA | NATURAL (WHITE) |
| 31068-1070 | 4 WAY MALE ASSEMBLY POLARIZATION "A" | YES | 31166-1040 | MALE HOUSING | BLACK |
| | | | 31167-0040 | TPA | NATURAL (WHITE) |
| 31068-1071 | 4 WAY MALE ASSEMBLY POLARIZATION "B" | YES | 31166-1041 | MALE HOUSING | GRAY |
| | | | 31167-0040 | TPA | NATURAL (WHITE) |
| 31068-1072 | 4 WAY MALE ASSEMBLY POLARIZATION "C" | YES | 31166-1042 | MALE HOUSING | BROWN |
| | | | 31167-0040 | TPA | NATURAL (WHITE) |

| ASSEMBLY PART NUMBER | DESCRIPTION | XMAS TREE ATTACHMENT FEATURE | PART NUMBER | DESCRIPTION | COLOR |
|----------------------|--------------------------------------|------------------------------|-------------|--------------|-----------------|
| 31072-1040 | 5 WAY MALE ASSEMBLY POLARIZATION "A" | NO | 31169-0050 | MALE HOUSING | BLACK |
| | | | 31170-0050 | TPA | NATURAL (WHITE) |
| 31072-1041 | 5 WAY MALE ASSEMBLY POLARIZATION "B" | NO | 31169-0051 | MALE HOUSING | GRAY |
| | | | 31170-0050 | TPA | NATURAL (WHITE) |
| 31072-1042 | 5 WAY MALE ASSEMBLY POLARIZATION "C" | NO | 31169-0052 | MALE HOUSING | BROWN |
| | | | 31170-0050 | TPA | NATURAL (WHITE) |
| 31072-1070 | 5 WAY MALE ASSEMBLY POLARIZATION "A" | YES | 31169-1050 | MALE HOUSING | BLACK |
| | | | 31170-0050 | TPA | NATURAL (WHITE) |
| 31072-1071 | 5 WAY MALE ASSEMBLY POLARIZATION "B" | YES | 31169-1051 | MALE HOUSING | GRAY |
| | | | 31170-0050 | TPA | NATURAL (WHITE) |
| 31072-1072 | 5 WAY MALE ASSEMBLY POLARIZATION "C" | YES | 31169-1052 | MALE HOUSING | BROWN |
| | | | 31170-0050 | TPA | NATURAL (WHITE) |
| 31073-1040 | 6 WAY MALE ASSEMBLY POLARIZATION "A" | NO | 31172-0060 | MALE HOUSING | BLACK |
| | | | 31173-0060 | TPA | NATURAL (WHITE) |
| 31073-1041 | 6 WAY MALE ASSEMBLY POLARIZATION "B" | NO | 31172-0061 | MALE HOUSING | GRAY |
| | | | 31173-0060 | TPA | NATURAL (WHITE) |
| 31073-1042 | 6 WAY MALE ASSEMBLY POLARIZATION "C" | NO | 31172-0062 | MALE HOUSING | BROWN |
| | | | 31173-0060 | TPA | NATURAL (WHITE) |
| 31073-1070 | 6 WAY MALE ASSEMBLY POLARIZATION "A" | YES | 31172-1060 | MALE HOUSING | BLACK |
| | | | 31173-0060 | TPA | NATURAL (WHITE) |
| 31073-1071 | 6 WAY MALE ASSEMBLY POLARIZATION "B" | YES | 31172-1061 | MALE HOUSING | GRAY |
| | | | 31173-0060 | TPA | NATURAL (WHITE) |
| 31073-1072 | 6 WAY MALE ASSEMBLY POLARIZATION "C" | YES | 31172-1062 | MALE HOUSING | BROWN |
| | | | 31173-0060 | TPA | NATURAL (WHITE) |

| | | | | | | | | |
|----------------------------------------------------------------------------------------------------|-----------------|------------------------------------------------------|----------------------|-------------------------------------------------------------------------------------------------------------------------------|---------------------|-------------------------------------|---------------------------|--|
| EC NO: UAU2009-1155 DRWN: THERFU2009/05/12 CHK: TANGELL2009/05/14 APPR: MKNACK 2009/05/14 | QUALITY SYMBOLS | GENERAL TOLERANCES (UNLESS SPECIFIED) | | SCALE 2:1 | DESIGN UNITS METRIC | THIRD ANGLE PROJECTION | REVISE ON CAD ONLY | |
| | ▽ - 0 ▽ - 0 | mm | INCH | DIMENSION STYLE MM ONLY | | MALE ASSEMBLY CHARTED SALES DRAWING | | |
| | | 4 PLACES ± --- ± --- | 3 PLACES ± --- ± --- | DRAWN BY | DATE | | | |
| | | 2 PLACES ± 0.13 ± --- | 1 PLACE ± 0.25 ± --- | DEMOE | 01/04/04 | | | |
| | ANGULAR ± 1/2 ° | DRAFT WHERE APPLICABLE MUST REMAIN WITHIN DIMENSIONS | | CHECKED BY | DATE | MOLEX INCORPORATED | | |
| | | | | APPROVED BY | DATE | MATERIAL NO. SEE CHART | DOCUMENT NO. SD-31110-003 | |
| | | | | THIS DRAWING CONTAINS INFORMATION THAT IS PROPRIETARY TO MOLEX INCORPORATED AND SHOULD NOT BE USED WITHOUT WRITTEN PERMISSION | | | SHEET NO. 3 OF 3 | |