



LIGITEK

LIGITEK ELECTRONICS CO.,LTD.
Property of Ligitek Only

3W Power Light LED

LGLV-313E

DATA SHEET

DOC. NO : QW0905-LGLV-313E

REV. : A

DATE : 27 - Feb - 2009



Features

- *. High Flux per LED
- *. Very long operating life(up to 100k hours).
- *. Available in White.
- *. More Energy Efficient than Incandescent and most Halogen lamps.
- *. Low voltage DC operated..
- *. Cool beam, safe to the touch.
- *. Instant light(less than 100 ns).
- *. Fully dimmable.
- *. No UV.
- *. Superior ESD protection..
- *. Soldering methods: hand Soldering.

Typical Applications

- *. Reading Light (car,bus,aircraft)
- *. Portable(flashlight,bicycle).
- *. LCD Backlights / Light Guides.
- *. Automotive Exterior (Stop-Tail-Tum,CHMSL,Mirror Side Repeat).
- *. Commercial and Residential Architectural lighting.
- *. Mini-accent / Uplighters / Downlighters / Orientation lighting
- *. Fiber Optic Alternative / Decorative / Entertainment lighting.
- *. Security / Garden lighting.
- *. Cove / Underself / Task lighting.
- *. Traffic signaling / Beacons / Rail crossing and Wayside lighting.
- *. Decorative.
- *. Sign and channel Letter.

Dimension

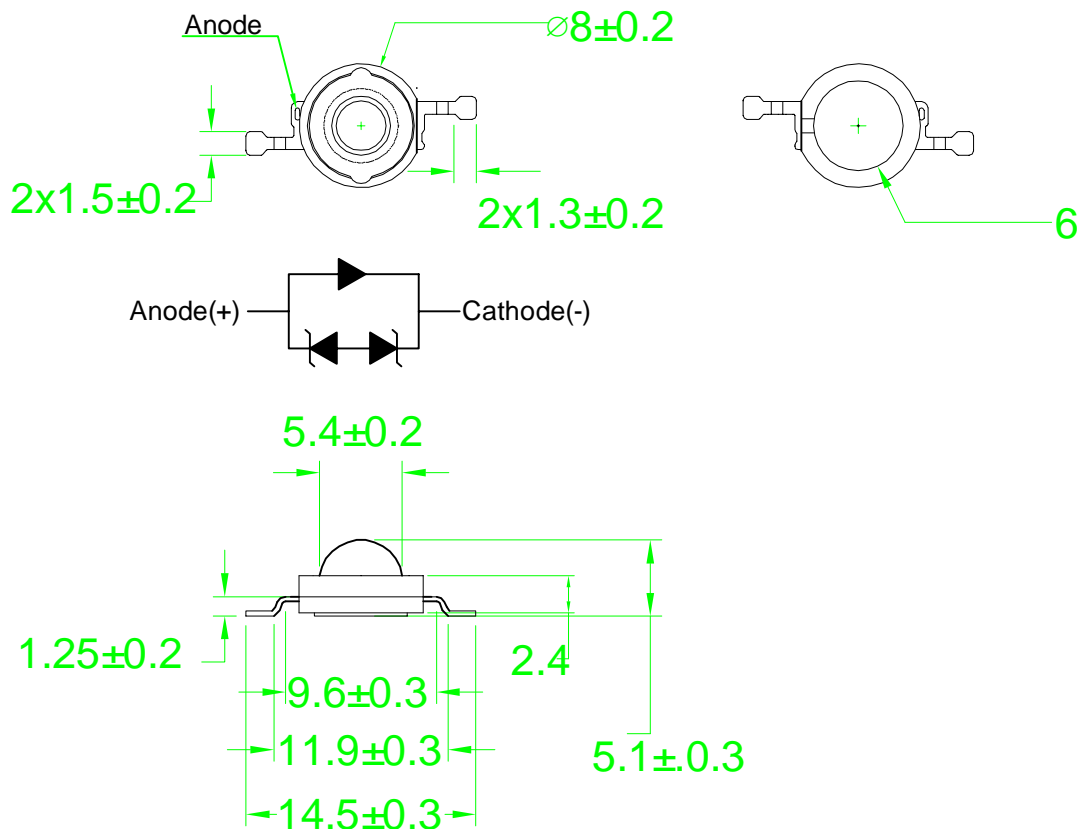

- Note:1. All dimension are in millimeter.
 2. The anode side of the device is denoted by a hole in the lead frame.
 3. The slug has polarity as anode.
 4. It is strongly recommended to apply on electrically isolated heat conducting film between the slug and contact surfaces.
 5. Drawings are not to scale.
 6. All dimensions without tolerances are for reference only.



Absolute Maximum Ratings at Ta=25

Parameter	Symbol	Ratings	UNIT
		Warm White	
DC Forward Current	IF	700	mA
Power Dissipation	PD	2.8	W
Peak pulse current Duty 1/10@10KHz	IFP	1000	mA
LED junction Temperature	Tj	125	
Reverse Current(VR=5V)	Ir	100	μ A
ESD Sensitivity	VB	±4000	V
Storage Temperature	Tstg	-40 ~ +120	
Operating Temperature	Topr	-40 ~ +100	
Manual Soldering Time at 260°C(Max)	Tsol	5	seconds

NOTE:

1. Proper current derating must be observed to maintain temperature below the maximum.
2. LEDs are not designed to be driven in reverse bias.

. Luminous Flux Characteristics at 700mA (Ratings At 25 Ambient)

Radiation Pattern	PART NO	Emission Color	Luminous Flux @700mA(lm)			Units
			Min.	Typ.	Max.	
Lambertian	LGLV-313E	Warm White	87.4	100	----	lm

Note :

1. White emitters are built with InGaN.
2. Flux and power is measured with an accuracy of ±10%



. Forward Voltage Characteristics at 700mA

(Ratings At 25 Ambient)

Radiation Pattern	PART NO	Emission Color	Vf			Units
			Min.	Typ.	Max.	
Lambertian	LGLV-313E	Warm White	3.0	3.6	4.0	V

Note : Forward Voltage is measured with an accuracy of ±0.1V

. Color Temperature Characteristics at 700mA

(Ratings At 25 Ambient)

Radiation Pattern	PART NO	Emission Color	CCT			Units
			Min.	Typ.	Max.	
Lambertian	LGLV-313E	Warm White	2670	----	3800	K

Note : CCT±5% tester tolerance.

. Temperature Coefficient Of Forward Voltage&Thermal Resistance Junction To Board Characteristics at 700mA

(Ratings At 25 Ambient)

Radiation Pattern	PART NO	Emission Color	$\Delta Vf/\Delta T$		Rth,j-B	
			Typ.	Units	Typ.	Units
Lambertian	LGLV-313E	Warm White	-2	mV/°C	18	°C/W

. Emission Angle Characteristics at 700mA

(Ratings At 25 Ambient)

PART NO	Emission Color	Lambertian	Units
LGLV-313E	Warm White	130	Degrees



Brightness Code For High Power LED

Group	Luminous flux(lm)	
	Min	Max
F25	87.4	113.6
F26	113.6	147.7

Note : Flux is measured with an accuracy of $\pm 10\%$

White Binning Structure Graphical Representation

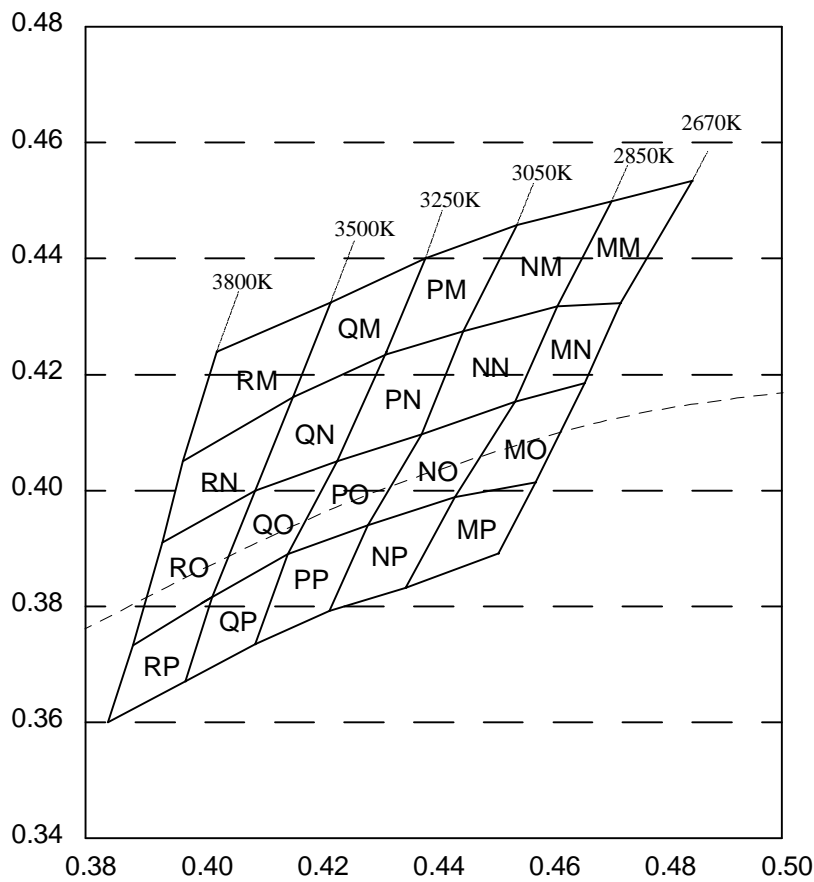



Color Bins

White Bin Structure

20 color bins, CCT range 3800K to 2670K

Bin Code	x	y	Typ. CCT (K)
MO	0.453	0.416	2760
	0.444	0.399	
	0.458	0.403	
	0.467	0.420	
MN	0.461	0.433	2760
	0.453	0.416	
	0.467	0.420	
	0.477	0.437	
MP	0.458	0.403	2760
	0.444	0.399	
	0.436	0.384	
	0.449	0.388	
MM	0.471	0.451	2760
	0.461	0.433	
	0.477	0.437	
	0.487	0.454	
NO	0.438	0.412	2950
	0.429	0.394	
	0.444	0.399	
	0.453	0.416	
NN	0.446	0.429	2950
	0.438	0.412	
	0.453	0.416	
	0.461	0.433	
NP	0.444	0.399	2950
	0.429	0.394	
	0.422	0.379	
	0.436	0.384	
NM	0.454	0.446	2950
	0.446	0.429	
	0.461	0.433	
	0.471	0.451	
PO	0.424	0.406	3150
	0.416	0.389	
	0.429	0.394	
	0.438	0.412	
PN	0.431	0.423	3150
	0.424	0.407	
	0.438	0.412	
	0.446	0.429	
PP	0.429	0.394	3150
	0.416	0.389	
	0.410	0.374	
	0.422	0.379	
PM	0.438	0.440	3150
	0.431	0.423	
	0.446	0.429	
	0.454	0.446	
QO	0.409	0.400	3375
	0.402	0.382	
	0.416	0.389	
	0.424	0.406	
QN	0.415	0.416	3375
	0.409	0.400	
	0.424	0.407	
	0.431	0.423	
QP	0.416	0.389	3375
	0.402	0.382	
	0.397	0.367	
	0.410	0.374	
QM	0.421	0.433	3375
	0.415	0.416	
	0.431	0.423	
	0.438	0.440	
RO	0.392	0.391	3650
	0.387	0.374	
	0.402	0.382	
	0.409	0.400	
RN	0.415	0.416	3650
	0.409	0.400	
	0.392	0.391	
	0.396	0.404	
RP	0.387	0.374	3650
	0.383	0.360	
	0.397	0.367	
	0.402	0.382	
RM	0.421	0.433	3650
	0.415	0.416	
	0.396	0.404	
	0.402	0.423	

NOTE: Tolerance on each color bin(x,y)is±0.01



Recommended Solder Pad Design

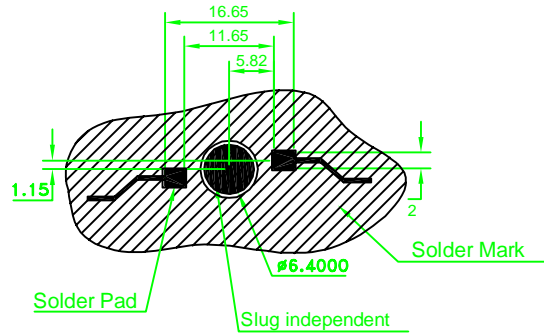

NOTE:

1. All dimensions are in mm.
2. The drawings are not to scale.
3. Solder pad can't be connected to slug.

Manual Hand Soldering

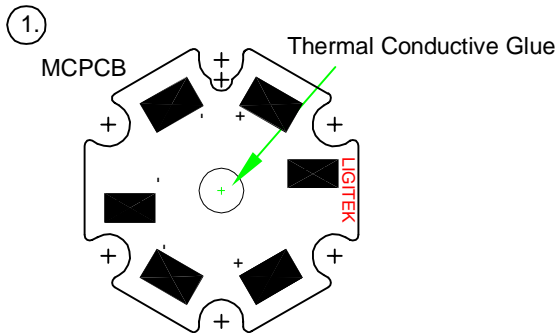

Place Thermal Conductive Glue on the MCPCB.

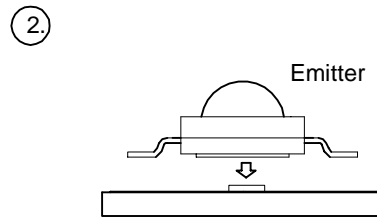

Place Emitter on the MCPCB.

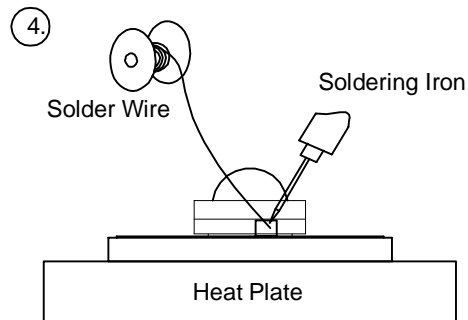
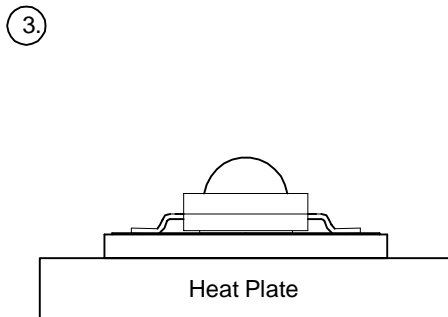

Use Soldering Iron to solder the leads of Emitter within 5 seconds.

- * For prototype builds or small series production runs it possible to place and solder the emitters by hand.
- * Solder tip temperature : 230°C max for Lead Solder and 260°C max for Lead-Free Solder.
- * Avoiding damage to the emitter or to the MCPCB dielectric layer.
Damage to the epoxy layer can cause a short circuit in the array.
- * Do not let the solder contact from solder pad to back-side of MCPCB.
This one will cause a short circuit and damage emitter.



Fig.1 Forward current vs. Forward Voltage

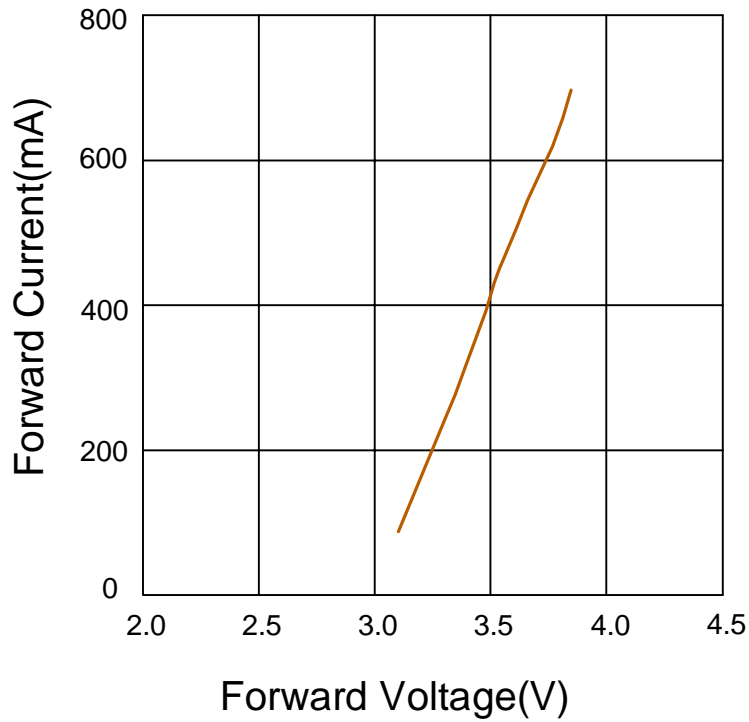

Fig.2 Operating current vs. Ambient Temperature

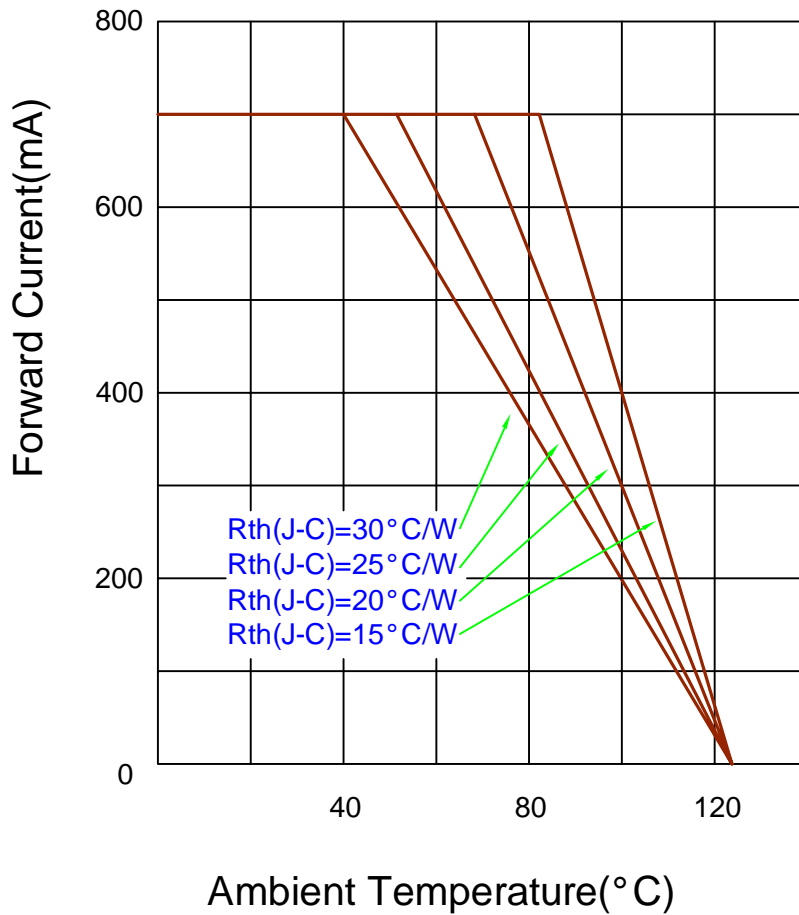



Fig.3 Forward current vs. Luminous Flux

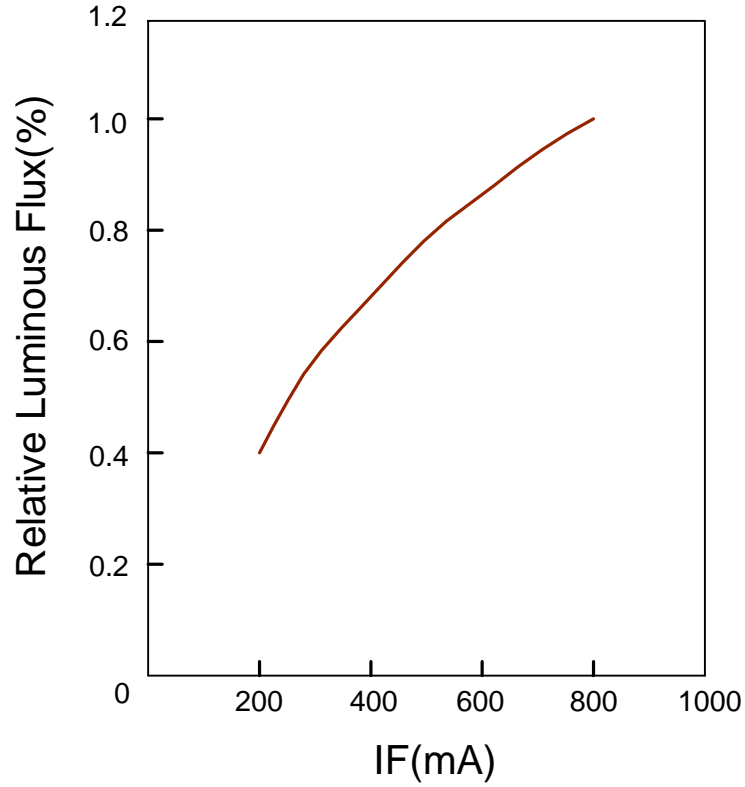

Fig.4 Junction Temperature vs. Forward Voltage

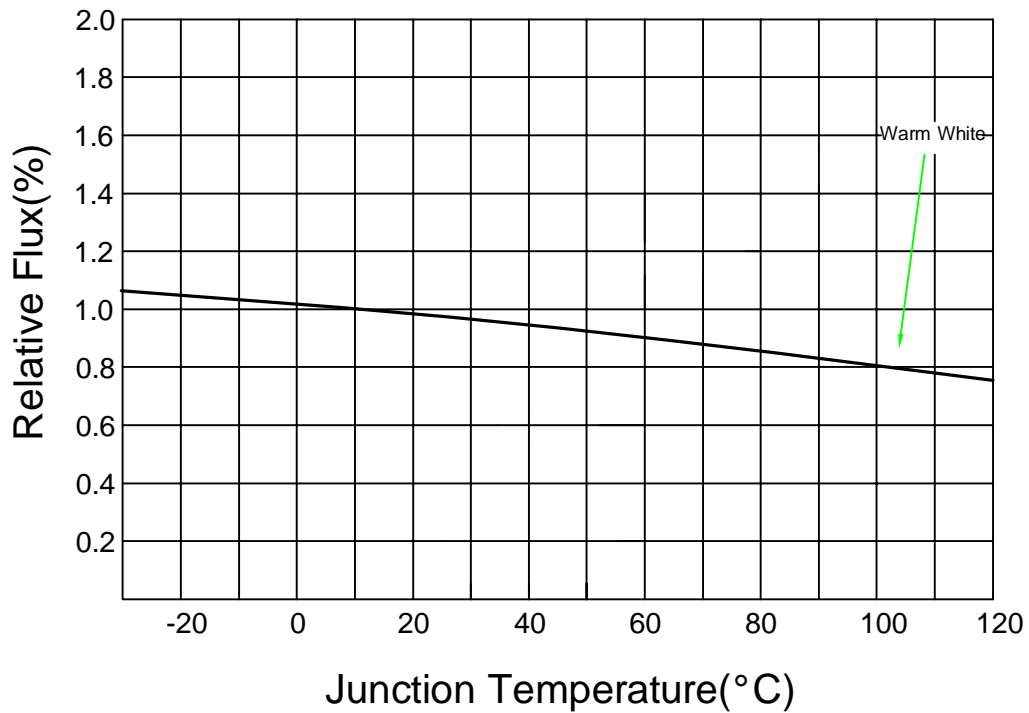



Fig.5 Luminous Spectrum($T_a=25^\circ\text{C}$)

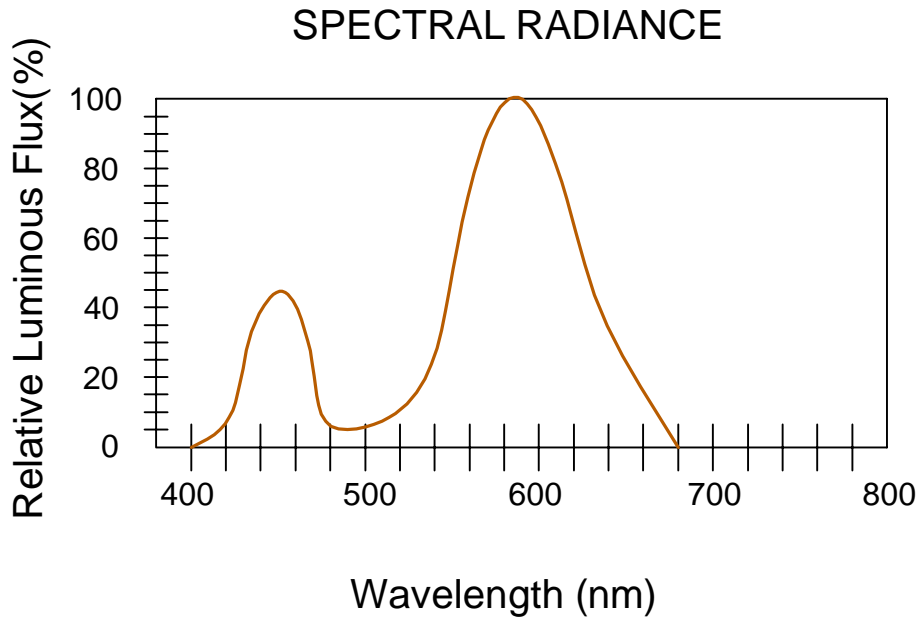
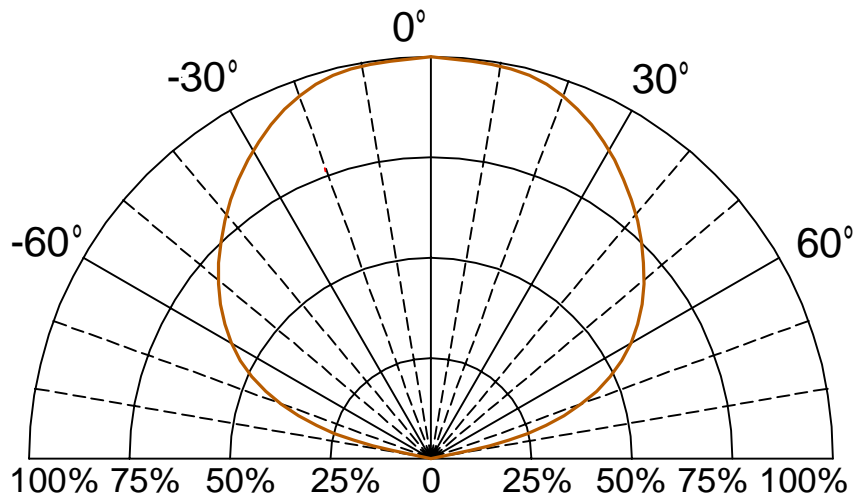

Fig.6 Directivity Radiation





PACKING SPECIFICATION

1. 35PCS / TUBE

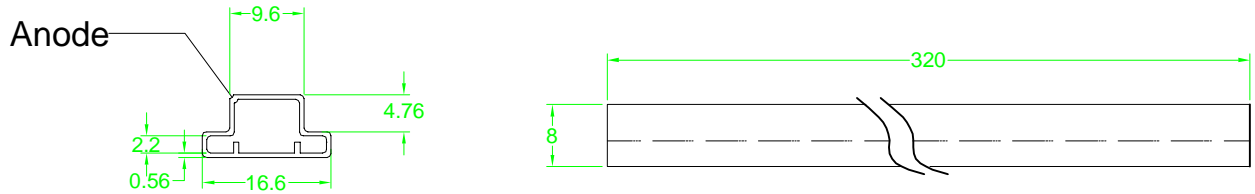

2. 30 TUBES / INNER BOX (10*3)

SIZE : L X W X H 33.5cm X 19cm X 7.5cm

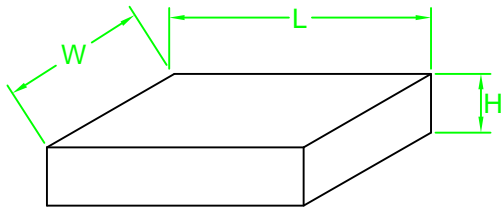

3. 12 INNER BOXES / CARTON

SIZE : L X W X H 58.5cm X 34cm X 34cm

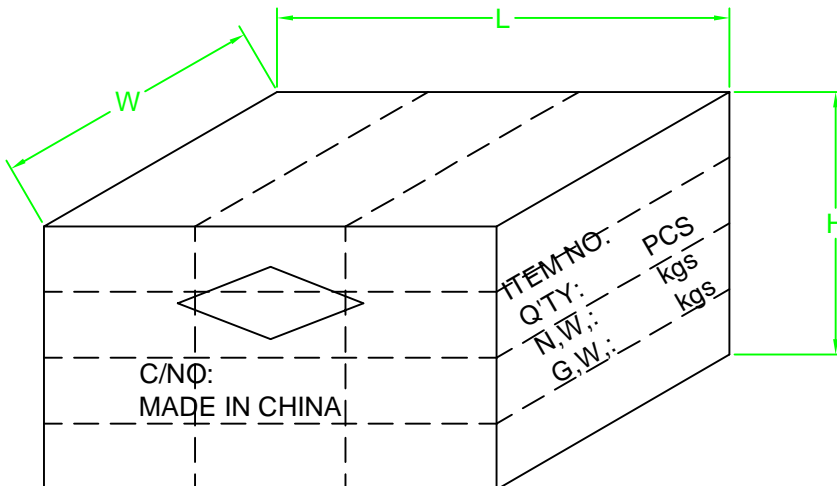



Reliability Test

Item	Description	Stress Condition	Test Duration
RTOL	Room Temperature Operation Life	25° C, Max. IF	1000 hours
WHT	Wet High Temperature	85° C/85%RH	1000 hours
TC	Temperature Cycling	-40/+110° C, 30min dwell,<5min trans.	200 cycles
TS	Thermal Shock	-40/+110° C, 20min dwell,<20min trans.	200 cycles
HTSL	High Temperature Storage Life	120° C	1000 hours
LTSL	Low Temperature Storage Life	-40° C	1000 hours
SHR	Solder Heat Resistance	260±5° C, 5secs	
MS	Mechanical Shock	1500G,0.5msec pulse, 5 shocks each 6 axis	
ND	Natural Drop	On concrete from 1.2m, 3xtimes	
RV	Random Vibration	6G RMS from 10 to 2KHz, 10mins/axis	
VVF	Variable Vibration Frequency	10-2000-10Hz, 20G 1 min, 1.5mm, 3timesx/axis	

Note :

Failure criteria:

Electrical failures

V_F shife >= 10%

I_R < 50uA@V_r = 5v

Ligitek output Degradation

%I_v shift >= 30% @1000hrs or 200cycle

Visual failures

Broken or damaged package or lead

Dimension out of tolerance