

NARROW-PITCH FOR BOARD-TO-FPC CONNECTION

NARROW PITCH (0.35 mm) CONNECTORS F35S SERIES

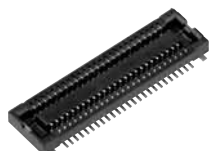

Socket



Header

Compliance with RoHS Directive

FEATURES

1. Space-saving design (0.35 mm pitch)

The footprint when mated is down approx. 15% from our existing F4S model (40 contacts), contributing to the functionality enhancement and size reduction of target equipment.

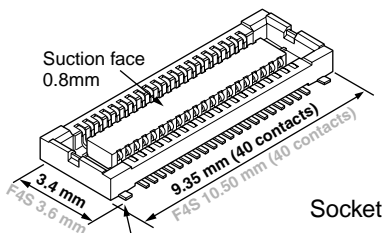

Socket

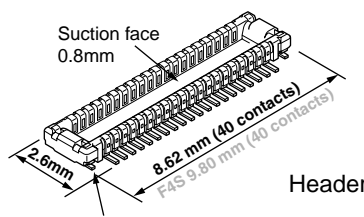

Header

Clips (soldering terminals) at the four corners

Clips (soldering terminals) at the four corners

2. Strong resistance to adverse environments **TOUGH CONTACT** construction

Ni barrier construction
(Tough against solder rise!)

Bellows contact construction
(Tough against dropping!)

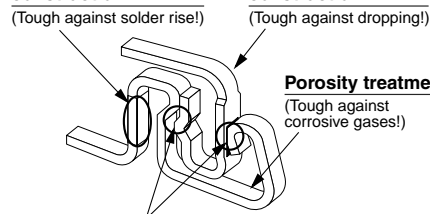

Porosity treatment
(Tough against corrosive gases!)

V notch and Double contact constructions
(Tough against foreign particles and flux!)

3. The clips (soldering terminals) at the four corners enhance the mounting strength.

4. The simple lock structure ensures a superior mating/unmating operation feel.

5. The gull-wing-shaped terminals facilitate imaging inspections.

APPLICATIONS

Particularly suitable for board-to-FPC connections in ultra-compact mobile equipment that requires size and thickness reduction and functionality enhancement

ORDERING INFORMATION

AXT

7: Narrow Pitch Connector F35S (0.35 mm pitch) Socket
8: Narrow Pitch Connector F35S (0.35 mm pitch) Header

Number of contacts (2 digits)

Mated height
<Socket> / <Header>

1: For mated height 1.0 mm

Functions
2: Without positioning bosses

Surface treatment (Contact portion / Terminal portion)

<Socket>

4: Base: Ni plating, Surface: Au plating (for Ni barrier available)

<Header>

4: Base: Ni plating, Surface: Au plating

AXT7, 8

PRODUCT TYPES

Mated height	Number of contacts	Part number		Packing	
		Socket	Header	Inner carton	Outer carton
1.0mm	40	AXT740124	AXT840124	3,000 pieces	6,000 pieces
	50	AXT750124	AXT850124		
	60	AXT760124	AXT860124		
	70	AXT770124	AXT870124		
	80	AXT780124	AXT880124		

- Notes: 1. Order unit: For mass production: in 1-inner-box (1-reel) units
 Samples for mounting check: in 50-connector units. Please contact our sales office.
 2. The above part numbers are for connectors without positioning bosses, which are standard. When ordering connectors with positioning bosses, please contact our sales office.
 3. Please contact us for connectors having a number of contacts other than those listed above.

SPECIFICATIONS

1. Characteristics

	Item	Specifications	Conditions
Electrical characteristics	Rated current	0.25A/contact (Max. 4 A at total contacts)	
	Rated voltage	60V AC/DC	
	Breakdown voltage	150V AC for 1 min.	No short-circuiting or damage at a detection current of 1 mA when the specified voltage is applied for one minute.
	Insulation resistance	Min. 1.000M Ω (initial)	Using 250V DC megger (applied for 1 min.)
	Contact resistance	Max. 100m Ω	Based on the contact resistance measurement method specified by JIS C 5402.
Mechanical characteristics	Composite insertion force	Max. 0.981N/contacts \times contacts (initial)	
	Composite removal force	Min. 0.165N/contacts \times contacts	
	Contact holding force (Socket contact)	Min. 0.49N/contacts	Measuring the maximum force. As the contact is axially pull out.
Environmental characteristics	Ambient temperature	-55°C to +85°C	No freezing at low temperatures. No dew condensation.
	Soldering heat resistance	Peak temperature: 260°C or less (on the surface of the PC board around the connector terminals)	Infrared reflow soldering
		300°C within 5 sec. 350°C within 3 sec.	Soldering iron
	Storage temperature	-55°C to +85°C (product only) -40°C to +50°C (emboss packing)	No freezing at low temperatures. No dew condensation.
	Thermal shock resistance (header and socket mated)	5 cycles, insulation resistance min. 100M Ω , contact resistance max. 100m Ω	Sequence 1. -55 $\frac{3}{0}$ °C, 30 minutes 2. ~, Max. 5 minutes 3. 85 $\frac{3}{0}$ °C, 30 minutes 4. ~, Max. 5 minutes
	Humidity resistance (header and socket mated)	120 hours, insulation resistance min. 100M Ω , contact resistance max. 100m Ω	Bath temperature 40 \pm 2°C, humidity 90 to 95% R.H.
	Saltwater spray resistance (header and socket mated)	24 hours, insulation resistance min. 100M Ω , contact resistance max. 100m Ω	Bath temperature 35 \pm 2°C, saltwater concentration 5 \pm 1%
H ₂ S resistance (header and socket mated)	48 hours, contact resistance max. 100m Ω	Bath temperature 40 \pm 2°C, gas concentration 3 \pm 1 ppm, humidity 75 to 80% R.H.	
Lifetime characteristics	Insertion and removal life	50 times	Repeated insertion and removal speed of max. 200 times/hours
Unit weight		40-contact type: Socket: 0.04 g Header: 0.02 g	

2. Material and surface treatment

Part name	Material	Surface treatment
Molded portion	LCP resin (UL94V-0)	—
Contact and Post	Copper alloy	Contact portion: Base: Ni plating, Surface: Au plating Terminal portion: Base: Ni plating, Surface: Au plating (except the terminal tips) The socket terminals close to the portion to be soldered have nickel barriers (exposed nickel portions). Clips (soldering terminals): Sockets: Base: Ni plating, Surface: Pd+Au flash plating (except the terminal tips) Headers: Base: Ni plating, Surface: Au plating (except the terminal tips)

DIMENSIONS (Unit: mm)

Socket (Mated height: 1.0 mm)

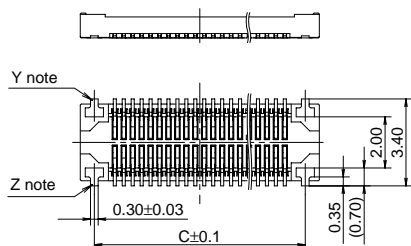
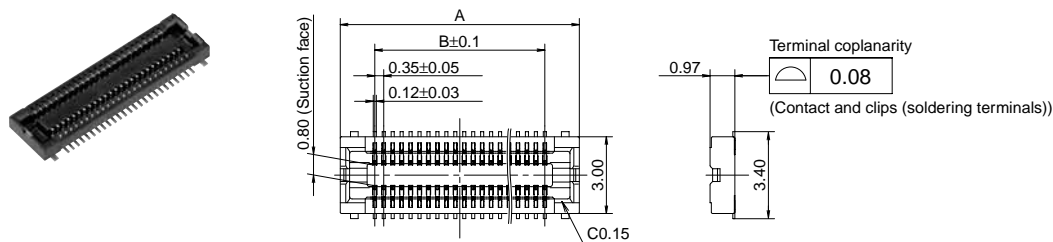

Dimension table (mm)

Number of contacts/ dimension	A	B	C
40	9.35	6.65	8.25
50	11.10	8.40	10.00
60	12.85	10.15	11.75
70	14.60	11.90	13.50
80	16.35	13.65	15.25

General tolerance: ±0.2

Note: Since the clips (soldering terminals) are built into the body, the sections Y and Z are electrically connected.

Header (Mated height: 1.0 mm)

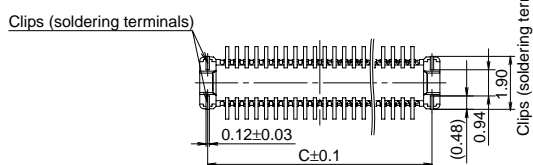
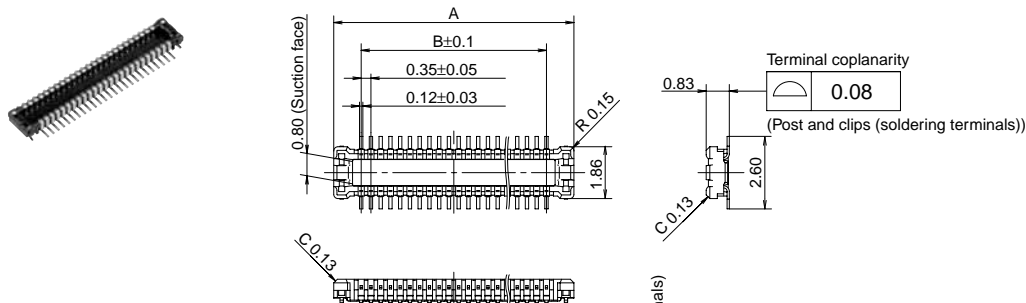

Dimension table (mm)

Number of contacts/ dimension	A	B	C
40	8.62	6.65	8.05
50	10.37	8.40	9.80
60	12.12	10.15	11.55
70	13.87	11.90	13.30
80	15.62	13.65	15.05

General tolerance: ±0.2

• Socket and Header are mated

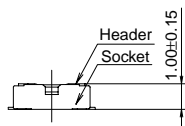

AXT7, 8

EMBOSSED TAPE DIMENSIONS (Unit: mm) (Common to all sockets and headers)

• Specifications for taping

(In accordance with JIS C 0806-1990. However, not applied to the mounting-hole pitch of some connectors.)

• Specifications for the plastic reel

(In accordance with EIAJET-7200B.)

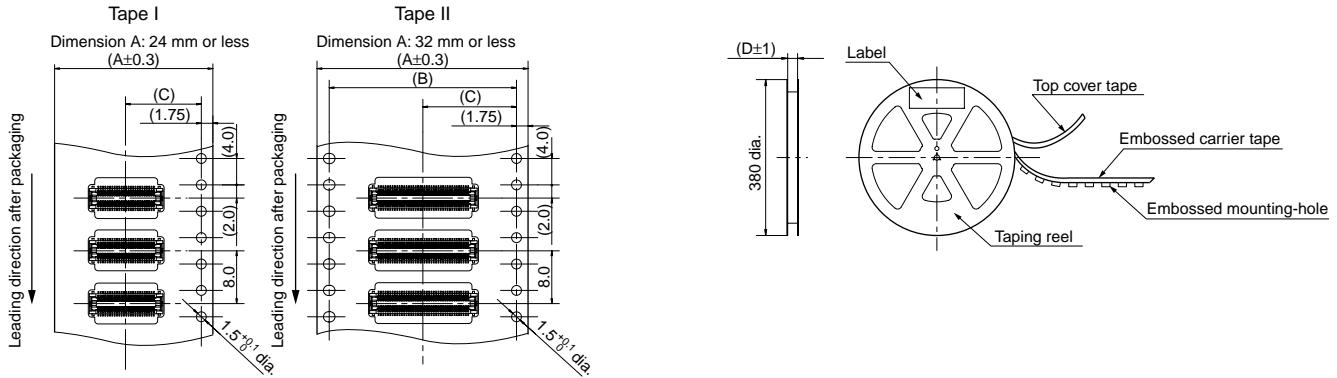

• Dimension table (Unit: mm)

Type/Mated height	Number of contacts	Type of taping	A	B	C	D	Quantity per reel
Common for sockets and headers: 1.0mm	40 to 70	Tape I	24.0	—	11.5	25.4	3,000
	80	Tape II	32.0	28.4	14.2	33.4	3,000

• Connector orientation with respect to embossed tape feeding direction

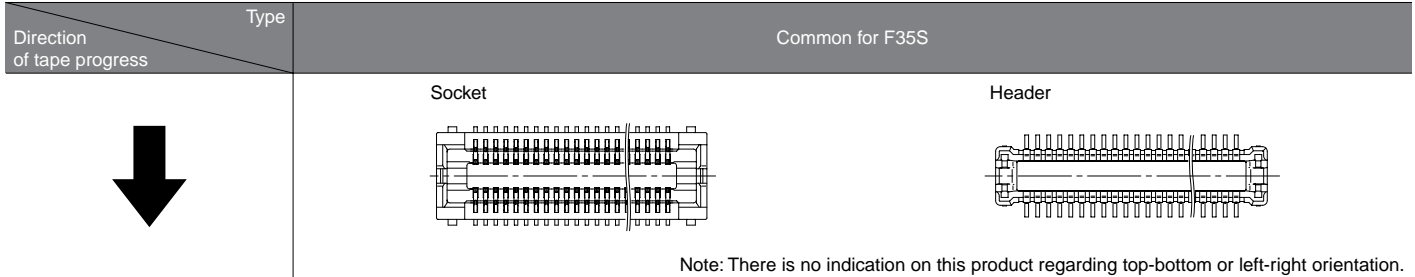

Note: There is no indication on this product regarding top-bottom or left-right orientation.

NOTES

1. Regarding the design of PC board patterns

Conduct the recommended foot pattern design, in order to preserve the mechanical strength of terminal solder areas.

2. Recommended PC board and metal mask patterns

Appropriate control of solder amount is required to minimize solder bridges and other defects for connectors with 0.35-mm, 0.4-mm or 0.5-mm pitch terminals, which require high-density mounting. Refer to the right-hand drawing for recommended patterns.

• Socket (Mated height: 1.0 mm)

Recommended PC board pattern (TOP VIEW)

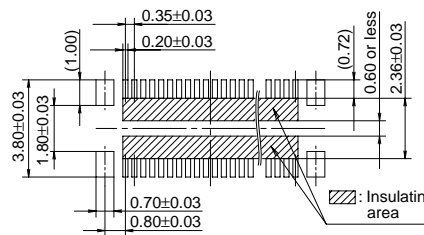

Recommended metal mask opening pattern

Metal mask thickness: When 120μm
(Terminal opening ratio: 65%)
(Metal-part opening ratio: 100%)

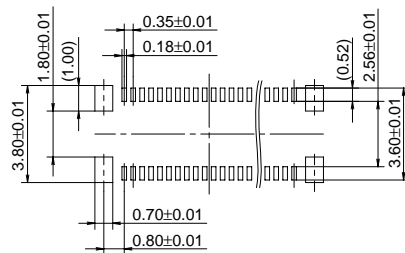

• Header (Mated height: 1.0 mm)

Recommended PC board pattern (TOP VIEW)

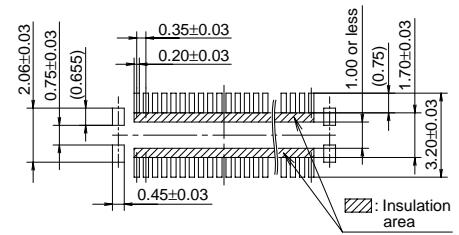

Recommended metal mask opening pattern

Metal mask thickness: When 120μm
(Terminal opening ratio: 60%)
(Metal-part opening ratio: 100%)

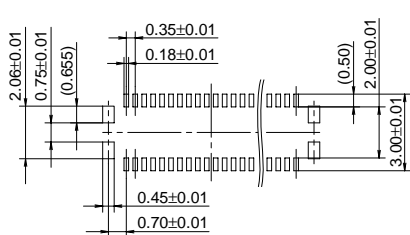

For other details, please verify with the product specification sheets.