

Features

- Attenuation: 0.5 dB Steps to 15.5 dB
- Low DC Power Consumption
- Integral TTL Driver
- 50 ohm Impedance
- Test Boards are Available
- Tape and Reel Packaging Available
- Lead-Free SOW-16 Package
- 100% Matte Tin Plating over Copper
- Halogen-Free “Green” Mold Compound
- 260°C Reflow Compatible
- RoHS* Compliant Version of AT65-0283

Schematic with Off-Chip Components

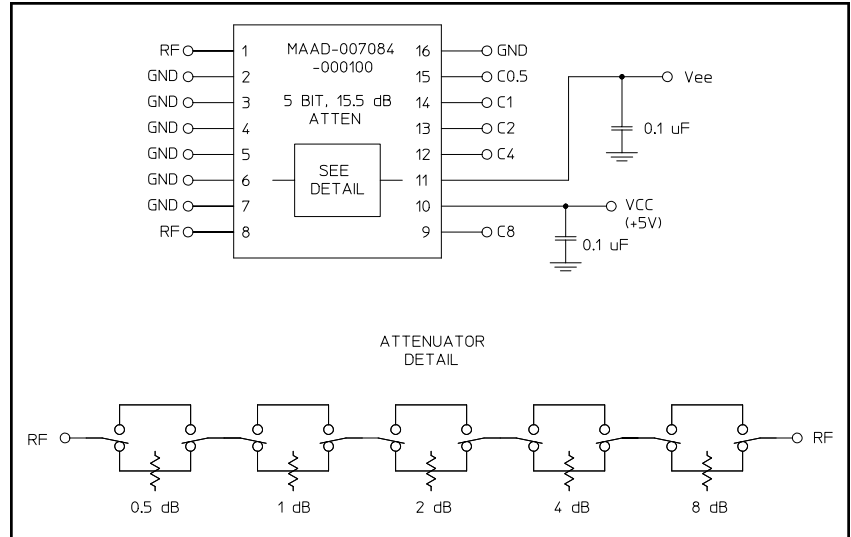

Description

M/A-COM's MAAD-007084-000100 is a GaAs FET 5-bit digital attenuator with integral TTL driver. Step size is 0.5 dB providing a 15.5 dB total attenuation range. This device is in a SOW-16 plastic surface mount package. The MAAD-007084-000100 is ideally suited for use where accuracy, fast speed, very low power consumption and low costs are required.

Pin Configuration

Pin No.	Function	Pin No.	Function
1	RF	9	C8
2	GND	10	Vcc
3	GND	11	Vee
4	GND	12	C4
5	GND	13	C2
6	GND	14	C1
7	GND	15	C0.5
8	RF	16	GND

Ordering Information

Part Number	Package
MAAD-007084-000100	Bulk Packaging
MAAD-007084-0001TR	1000 piece reel
MAAD-007084-0001TB	Sample Test Board

Note: Reference Application Note M513 for reel size information.

Note: Die quantity varies.

Truth Table (Digital Attenuator)

C8	C4	C2	C1	C0.5	Attenuation
0	0	0	0	0	Loss, Reference
0	0	0	0	1	0.5 dB
0	0	0	1	0	1.0 dB
0	0	1	0	0	2.0 dB
0	1	0	0	0	4.0 dB
1	0	0	0	0	8.0 dB
1	1	1	1	1	15.5 dB

0 = TTL Low; 1 = TTL High

* Restrictions on Hazardous Substances, European Union Directive 2002/95/EC.

Digital Attenuator 15.5 dB, 5-Bit, TTL Driver, DC-2.0 GHz

Rev. V2

Electrical Specifications: $T_A = 25^\circ\text{C}$, $Z_0 = 50\Omega$

Parameter	Test Conditions	Frequency	Units	Min	Typ	Max
Insertion Loss	—	DC - 1.0 GHz	dB	—	2.5	2.7
		DC - 2.0 GHz	dB	—	2.7	3.0
Attenuation Accuracy	Any Bit Any Combination of Bits	DC - 2.0 GHz	dB	—	—	$\pm(.3 + 4\% \text{ of atten})$
		DC -2.0 GHz	dB	—	—	$\pm (.3 + 6\% \text{ of atten})$
VSWR	Full Range	DC - 2.0 GHz	Ratio	—	1.5:1	2:1
Switching Speed ¹	50% Cntl to 90%/10% RF 10% to 90% or 90% to 10%	—	ns	—	75	150
		—	ns	—	20	50
1 dB Compression	—	50 MHz	dBm	—	+21	—
		0.5 - 2.0 GHz	dBm	—	+29	—
Input IP ₃	Two-tone inputs up to +5 dBm	50 MHz	dB	—	+35	—
		0.5-2.0 GHz	dB	—	+48	—
V _{CC}	—	—	V	4.75	5.0	5.25
V _{EE}	—	—	V	-8.0	-5.0	-4.75
V _{IL} V _{IH}	LOW-level input voltage HIGH-level input voltage	—	V	0.0	—	0.8
		—	V	2.0	—	5.0
I _{in} (Input Leakage Current)	V _{in} = V _{CC} or GND	—	uA	-1.0	—	1.0
I _{CC} (Quiescent Supply Current)	V _{cntrl} = V _{CC} or GND	—	uA	—	250	400
ΔI_{CC}^2 (Additional Supply Current Per TTL Input Pin)	V _{CC} = Max, V _{cntrl} = V _{CC} - 2.1 V	—	mA	—	—	1.0
I _{EE}	V _{EE} min to max, V _{in} = V _{IL} or V _{IH}	—	mA	-1.0	-0.2	—

- Decoupling capacitors (.01 μF) are required on power supply lines.
- For calculating ΔI_{CC} , the number of TTL input pins is 6.

Absolute Maximum Ratings^{3,4}

Parameter	Absolute Maximum
Max. Input Power 0.05 GHz 0.5 - 2.0 GHz	+27 dBm +34 dBm
V _{CC}	$-0.5\text{V} \leq V_{CC} \leq +7.0\text{V}$
V _{EE}	$-8.5\text{V} \leq V_{EE} \leq +0.5\text{V}$
V _{CC} - V _{EE}	$-0.5\text{V} \leq V_{CC} - V_{EE} \leq 14.5\text{V}$
V _{in} ⁵	$-0.5\text{V} \leq V_{in} \leq V_{CC} + 0.5\text{V}$
Operating Temperature	-40°C to +85°C
Storage Temperature	-65°C to +125°C

- Exceeding any one or combination of these limits may cause permanent damage to this device.
- M/A-COM does not recommend sustained operation near these survivability limits.
- Standard CMOS TTL interface, latch-up will occur if logic signal is applied prior to power supply.

Handling Procedures

Please observe the following precautions to avoid damage:

Static Sensitivity

Gallium Arsenide Integrated Circuits are sensitive to electrostatic discharge (ESD) and can be damaged by static electricity. Proper ESD control techniques should be used when handling these devices.

Typical Performance Curves

Insertion Loss

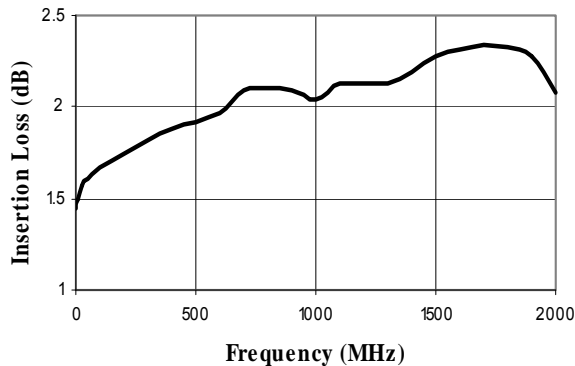

Attenuation Accuracy 0.5, 1, 2, and 4 dB Bits

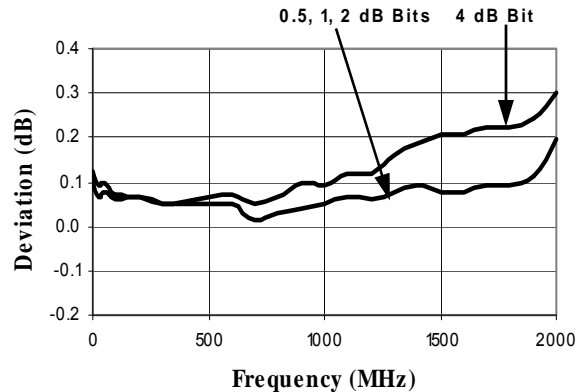

Attenuation Accuracy 8 dB Bit and Max. Attenuation

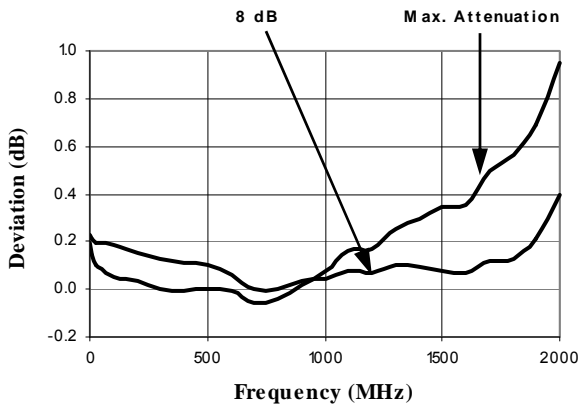

VSWR @ Insertion Loss

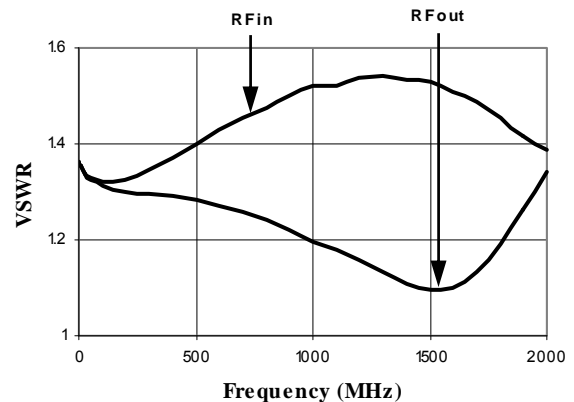

VSWR RF OUT 0.5, 1, 2, and 4 dB Bits

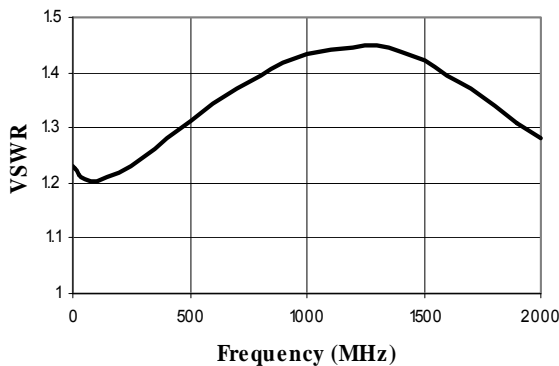

VSWR RF IN 0.5, 1, 2, 4, 8 dB Bits and Max. Attenuation

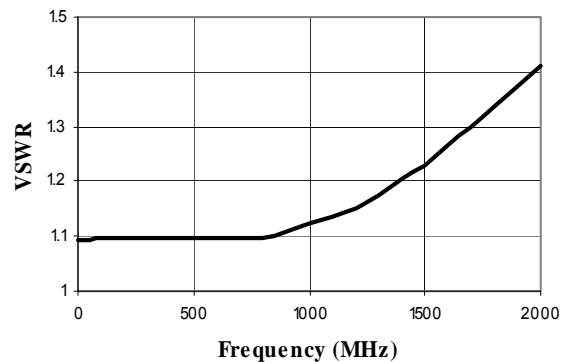

Typical Performance Curves

VSWR RF OUT 8 dB Bit and Max. Attenuation

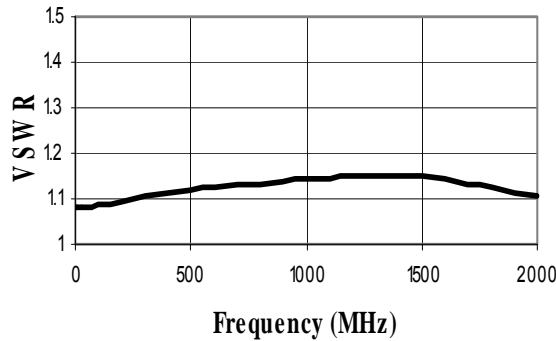

Lead-Free, SOW-16†

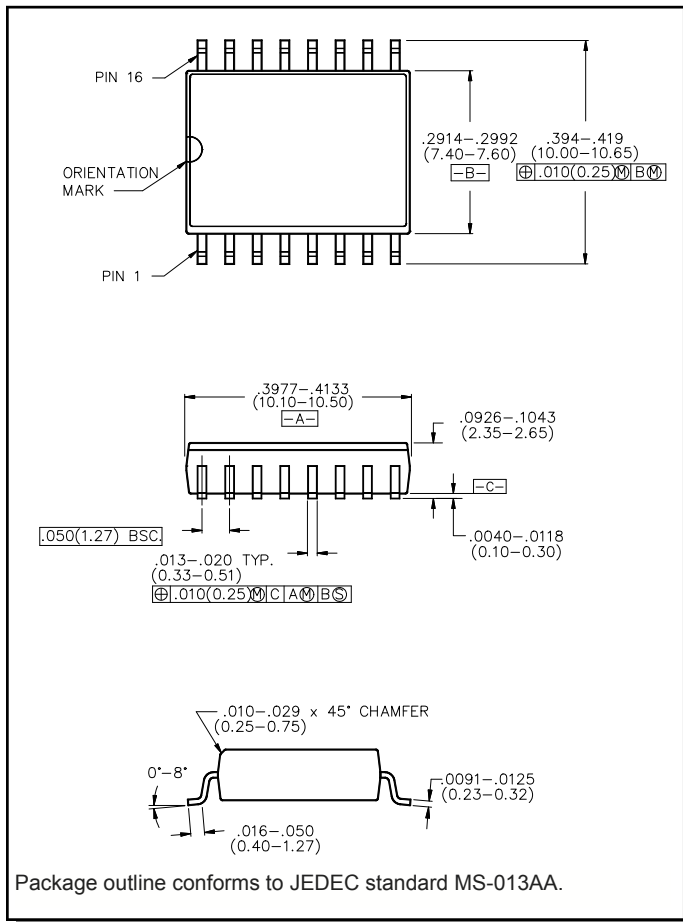

† Reference Application Note M538 for lead-free solder reflow recommendations.