

**PLEASE CHECK WWW.MOLEX.COM FOR LATEST PART INFORMATION**

**Part Number:** [5017843009](#)  
**Status:** **Active**  
**Description:** 0.50mm (.020") Pitch FFC-to-Board Connector, Plug Jacket Cover, 30 Circuits

**Documents:**

[Drawing \(PDF\)](#) [RoHS Certificate of Compliance \(PDF\)](#)  
[Product Specification PS-501864-004 \(PDF\)](#)

**General**

Product Family	Accessories
Series	501784
Component Type	Jacket Cover
Product Name	N/A

**Physical**

Breakaway	No
Circuits (Loaded)	N/A
Circuits (maximum)	30
Color - Resin	Black
Gender	Plug
Material - Resin	Polyester
Packaging Type	Bag
Polarized to Mating Part	Yes
Temperature Range - Operating	-40°C to +85°C

**Electrical**

Current - Maximum per Contact	0.5A
-------------------------------	------

**Material Info**

**Reference - Drawing Numbers**

Product Specification	PS-501864-004, RPS-501786-001, RPS-501864-001, RPS-501864-004
Sales Drawing	SD-501784-001, SD-501784-004

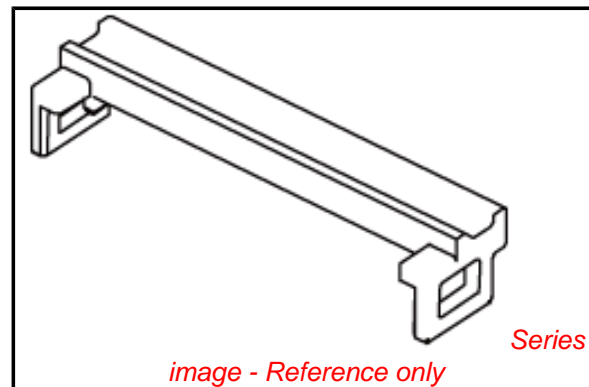

*image - Reference only*

**EU RoHS**

**ELV and RoHS  
Compliant**  
**REACH SVHC  
Contains SVHC: No**  
**Halogen-Free  
Status**

**China RoHS**



**Need more information on product  
environmental compliance?**

Email [productcompliance@molex.com](mailto:productcompliance@molex.com)  
 For a multiple part number RoHS Certificate of Compliance, [click here](#)

Please visit the [Contact Us](#) section for any non-product compliance questions.

**Search Parts in this Series**

[501784Series](#)

**Use With**

[501786](#) FFC-to-Board Connector, [501864](#) FFC-to-Board Connector, [501783](#) Plug Jacket

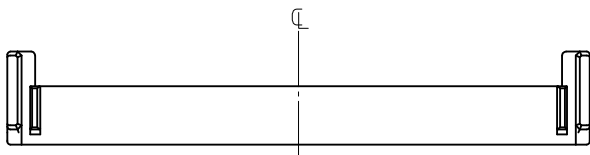
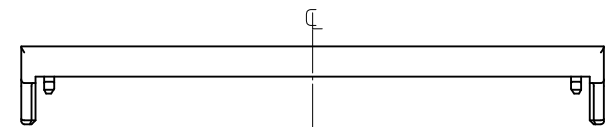
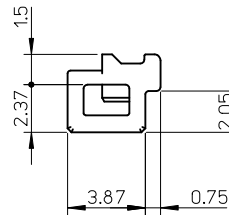
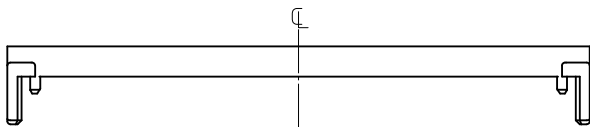
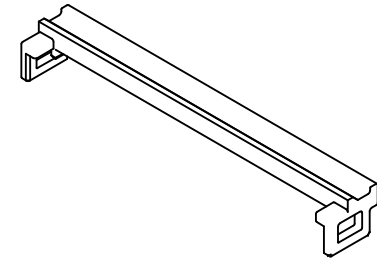
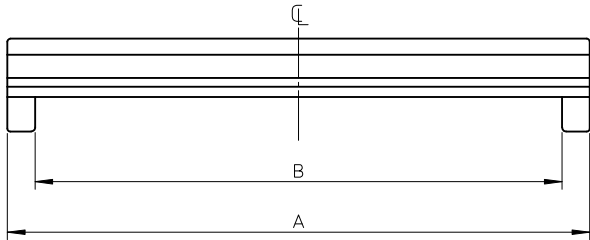

41.2	43.96	501784-8009	80
26.2	28.96	501784-5009	50
B	A	PLASTIC BAG PACKAGE	極数
		オーダー番号 ORDER NO.	CIRCUITS
CONNECTOR SERIES NO. 501784-**09			

注記  
NOTES

- 適合プラグジャケット: 501783-\*\*09  
APPLICABLE PLUG JACKET : 501783-\*\*09
- 材質  
MATERIAL  
PBT, UL94V-0, 色: 黒色  
PBT, UL94V-0, COLOR: BLACK

REVISED EC NO.: J2010-1937 DRWN: YMORI 2010/03/26 CHKD: MATSUURA 2010/03/26 APPR: KMORIKAWA 2010/05/10	DESCRIPTION	GENERAL TOLERANCES (UNLESS SPECIFIED)		DIMENSION STYLE MM ONLY		SCALE --//	DESIGN UNITS METRIC	THIRD ANGLE PROJECTION	
		10 UNDER	±0.2	DRAWN BY H. IJIMA	DATE 06/01/16	TITLE 0.5 FFC TO BOARD CONN PLUG JACKET COVER			
		10 OVER 30 UNDER	±0.25	CHECKED BY K. TAKAHASHI	DATE 06/01/16	MOLEX INCORPORATED			
		30 OVER	±0.3	APPROVED BY H. HIRATA	DATE 06/01/16				
A	REV	ANGULAR ±1 ° DRAFT WHERE APPLICABLE MUST REMAIN WITHIN DIMENSIONS		MATERIAL NO. 501784-**09	DOCUMENT NO. SD-501784-001	SHEET NO. 1 OF 1			
				SIZE A3	THIS DRAWING CONTAINS INFORMATION THAT IS PROPRIETARY TO MOLEX INCORPORATED AND SHOULD NOT BE USED WITHOUT WRITTEN PERMISSION				