

PLEASE CHECK WWW.MOLEX.COM FOR LATEST PART INFORMATION

Part Number: [0877051053](#)
Status: **Active**
Description: 1.00mm (.039") Pitch DDR-II DIMM Socket, Vertical, Center Keys, 3.66mm (.144") Tail Length, Beige Latches, with Beveled Metal Pins, 240 Circuits, Lead-Free

Documents:

[3D Model](#) [Product Specification PS-87705-002 \(PDF\)](#)
[Drawing \(PDF\)](#) [RoHS Certificate of Compliance \(PDF\)](#)

Agency Certification

CSA LR19980
 UL E29179

General

Product Family Memory Module Sockets
 Series [87705](#)
 Comments Latches in Beige Color
 Component Type Socket
 JEDEC Outline MO-237
 Product Name DDR2 DIMM

Physical

Circuits (Loaded) 240
 Color - Resin Black, Natural
 Durability (mating cycles max) 25
 Entry Angle Vertical (Top Entry)
 Flammability 94V-0
 Keying to Mating Part Yes
 Material - Metal Brass
 Material - Plating Mating Gold
 Material - Plating Termination Tin
 Material - Resin High Temperature Thermoplastic
 PC Tail Length (in) 0.144 In
 PC Tail Length (mm) 3.66 mm
 PCB Retention Yes
 PCB Thickness Recommended (in) 0.093 In
 PCB Thickness Recommended (mm) 2.40 mm
 Packaging Type Tray
 Pitch - Mating Interface (in) 0.039 In
 Pitch - Mating Interface (mm) 1.00 mm
 Plating min: Mating (µin) 15.2
 Plating min: Mating (µm) 0.38
 Plating min: Termination (µin) 101.6
 Plating min: Termination (µm) 2.54
 Temperature Range - Operating -10°C to +85°C
 Termination Interface: Style Through Hole

Electrical

Current - Maximum per Contact 0.5A
 Voltage - Maximum 30V
 Voltage Key 1.8V, Center

Solder Process Data

Duration at Max. Process Temperature (seconds) 5
 Lead-free Process Capability SMC & Wave Capable (TH only)
 Max. Cycles at Max. Process Temperature 1
 Process Temperature max. C 260

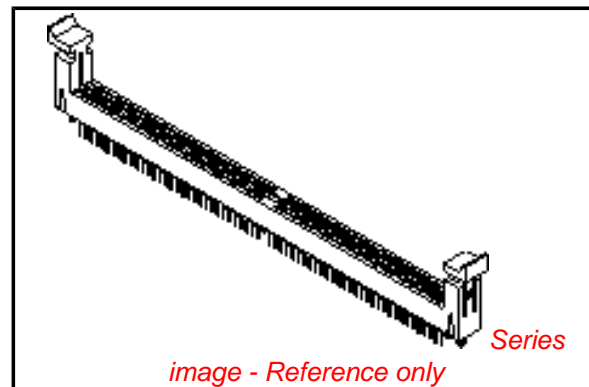

EU RoHS

**ELV and RoHS
 Compliant**
**REACH SVHC
 Contains SVHC: No**
**Halogen-Free
 Status
 Not Reviewed**

China RoHS



**Need more information on product
 environmental compliance?**

Email productcompliance@molex.com
 For a multiple part number RoHS Certificate of Compliance, [click here](#)

Please visit the [Contact Us](#) section for any non-product compliance questions.

Search Parts in this Series

[87705Series](#)

Mates With

JEDEC standard 1.27mm modules

Material Info

Reference - Drawing Numbers

Product Specification

PS-87705-002

Sales Drawing

SD-87705-001

This document was generated on 05/27/2010

PLEASE CHECK WWW.MOLEX.COM FOR LATEST PART INFORMATION

- NOTES:
- MATERIALS
 HOUSING - HIGH TEMP. NYLON GLASS FILLED, UL 94V-0
 COLOR: BLACK
 EJECTOR - HIGH TEMP. NYLON GLASS FILLED, UL 94V-0
 COLOR: SEE TABLE
 TERMINAL - COPPER ALLOY
 - PLATING - SEE TABLE IN SHEET 5 & 6.
 - CARD SLOT ACCEPTS 1.27±0.10 MM MODULE THICKNESS.
 (MEASURED OVER P.C. PADS)
 - RECOMMENDED MODULE LAYOUT SHALL BE AS PER JEDEC MO-237.
 - REFER TO PRODUCT SPEC. PS-87705-002 FOR PERFORMANCE SPECIFICATIONS.
 - PRODUCT SHALL BE PACKED IN TRAY.
 - PRODUCT SHALL HAVE DATE CODE STAMPED ON SIDE OF HOUSING.
 - KEEP OUT AREA IS THE AREA WHERE THE CONNECTOR IS MOUNTED ONTO THE PCB WHICH DOES NOT INCLUDE THE LATCH.
 - REFER TO CRITICAL JEDEC INFORMATION FOR SOCKET OUTLINE PER SO-001.
 - DIMM MODULE SEATING PLANE FROM TOP OF PCB.
 - CONTACT MOLEX FOR AVAILABILITY OF PRODUCT OPTIONS.
 - PART NUMBER SHALL BE MARKED LEGIBLY AS 87705-****

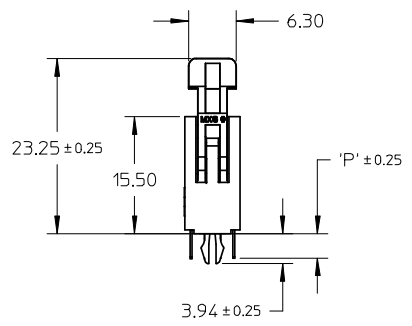
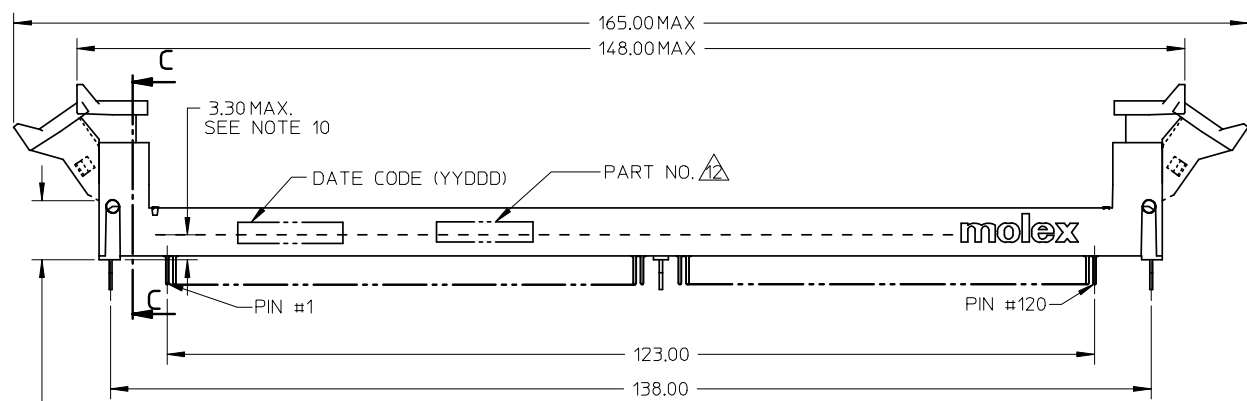
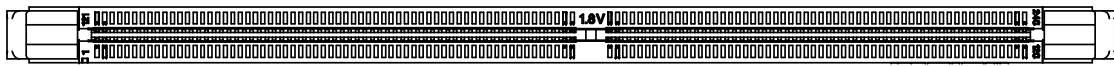

5.00 MIN
LATCH KEEP
OUT AREA

ADD NOTE @SHT4 C1 EC NO: S2008-1044 DRWN:CMTEO 2008/05/15 CHKD:CGTAN 2008/05/15 APPR:SHLENI 2008/05/15	QUALITY SYMBOLS ▽=0 ◻=0	GENERAL TOLERANCES (UNLESS SPECIFIED)		DIMENSION STYLE MM ONLY		SCALE NTS	DESIGN UNITS METRIC	THIRD ANGLE PROJECTION		
			mm	INCH	DRAWN BY CGOH	DATE 2002/05/09	TITLE DDR2 DIMM, 100MM PITCH 240 CKTS (FORKLOCK VERSION)			
		4 PLACES	± ---	± ---	CHECKED BY DSOH	DATE 2002/07/22	MOLEX MOLEX INCORPORATED			
		3 PLACES	± ---	± ---	APPROVED BY SKTOH	DATE 2002/07/23	MATERIAL NO. SEE TABLE	DOCUMENT NO. SD-87705-001	SHEET NO. 1 OF 6	
			2 PLACES	± 0.20	± ---	THIS DRAWING CONTAINS INFORMATION THAT IS PROPRIETARY TO MOLEX INCORPORATED AND SHOULD NOT BE USED WITHOUT WRITTEN PERMISSION				
			1 PLACE	± ---	± ---					
			ANGULAR ± 5 °							
		DRAFT WHERE APPLICABLE MUST REMAIN WITHIN DIMENSIONS								

10 9 8 7 6 5 4 3 2 1

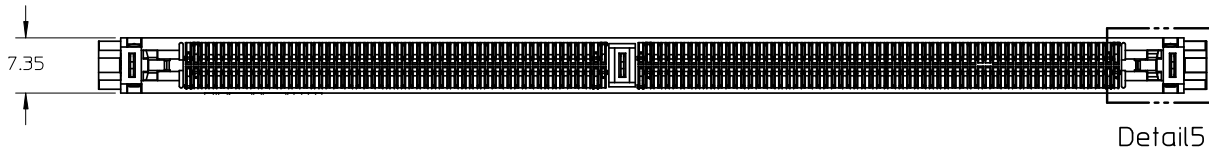

Detail5

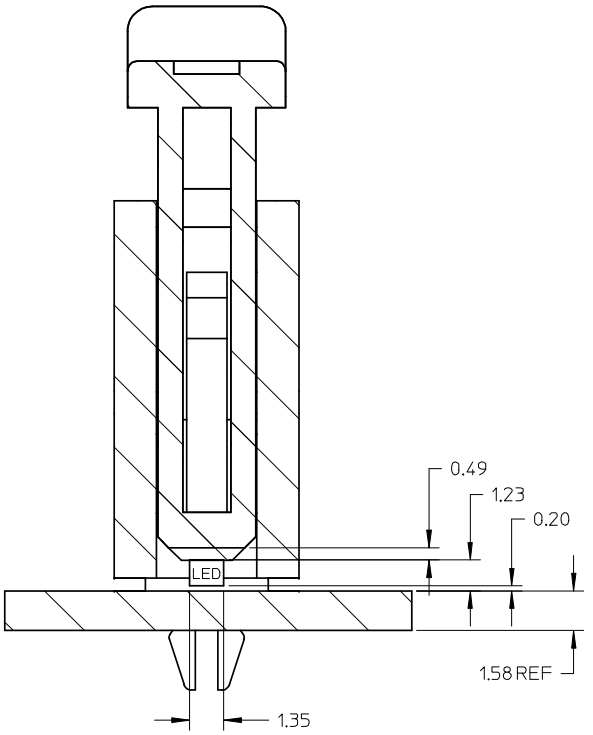

SECTION C-C

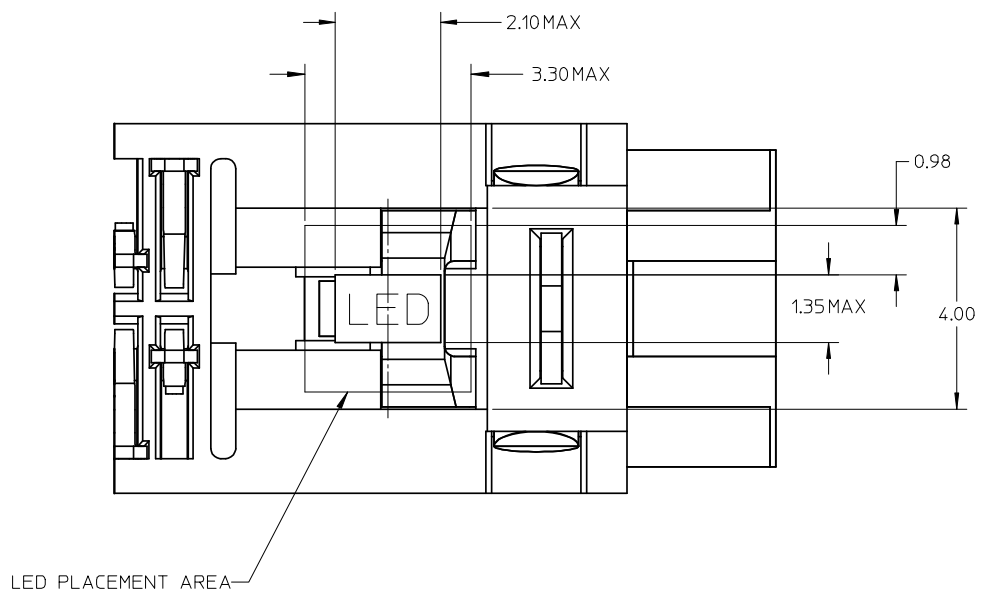

Detail 5

ADD NOTE @SHT 4 C1 EC NO: S2008-1044 DRW:CMTEO 2008/05/15 CHKD:CGTAN 2008/05/15 APPR:SHLENI 2008/05/15	DESCRIPTION REV	QUALITY SYMBOLS	GENERAL TOLERANCES (UNLESS SPECIFIED)		DIMENSION STYLE MM ONLY		SCALE NTS	DESIGN UNITS METRIC	THIRD ANGLE PROJECTION	
		$\nabla=0$ $\square=0$	mm	INCH	DRAWN BY CGOH	DATE 2002/05/09	TITLE DDR2 DIMM, 100MM PITCH 240 CKTS (FORKLOCK VERSION)			
			4 PLACES ± --- ± ---	3 PLACES ± --- ± ---	CHECKED BY DSOH	DATE 2002/07/22	MOLEX INCORPORATED			
			2 PLACES ± 0.20 ± ---	1 PLACE ± --- ± ---	APPROVED BY SKTOH	DATE 2002/07/23	DOCUMENT NO. SD-87705-001		SHEET NO. 2 OF 6	
		ANGULAR ± 5 °		MATERIAL NO. SEE TABLE		THIS DRAWING CONTAINS INFORMATION THAT IS PROPRIETARY TO MOLEX INCORPORATED AND SHOULD NOT BE USED WITHOUT WRITTEN PERMISSION				
DRAFT WHERE APPLICABLE MUST REMAIN WITHIN DIMENSIONS										

9 8 7 6 5 4 3 2 1

RECOMMENDED MODULE LAYOUT

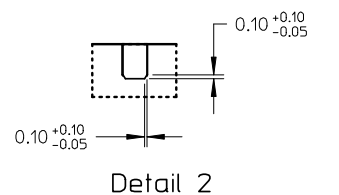
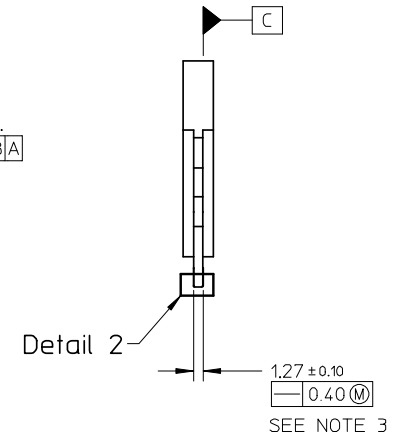
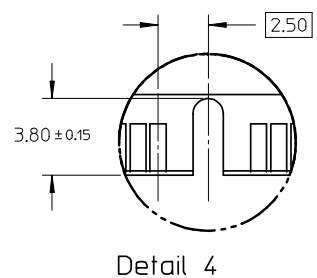
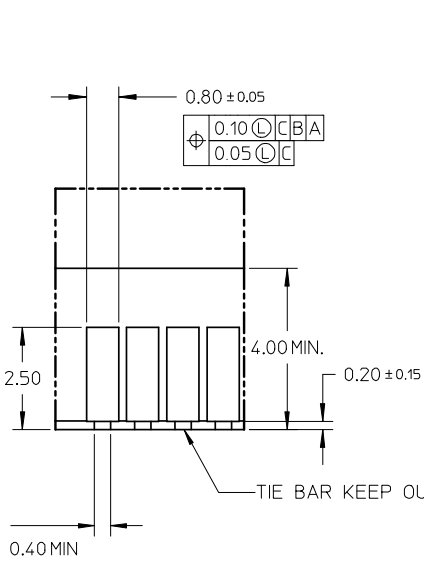
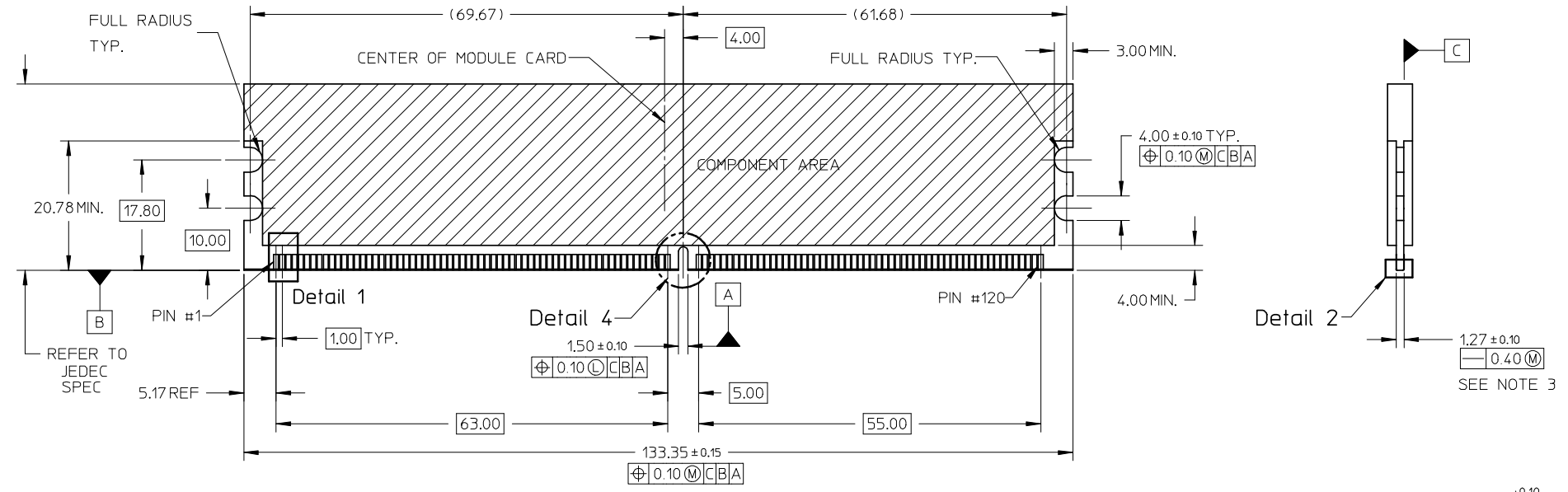

NOTES:
1. MODULE CARD USED FOR TESTS ARE WITH 0.10MM CHAMFER.

ADD NOTE @SHT4 C1 EC NO: S2008-1044 DRWN:CMTEO 2008/05/15 CHKD:CGTAN 2008/05/15 APPR:SIENI 2008/05/15	QUALITY SYMBOLS ▽=0 ▽=0	GENERAL TOLERANCES (UNLESS SPECIFIED)		DIMENSION STYLE MM ONLY		SCALE NTS	DESIGN UNITS METRIC	THIRD ANGLE PROJECTION		
			mm	INCH	DRAWN BY	DATE	TITLE			
		4 PLACES	± ---	± ---	CGOH	2002/05/09	DDR2 DIMM, 100MM PITCH			
		3 PLACES	± ---	± ---	CHECKED BY	DATE	240 CKTS			
						MOLEX INCORPORATED				
						SD-87705-001				
						3 OF 6				
						SEE TABLE				
						THIS DRAWING CONTAINS INFORMATION THAT IS PROPRIETARY TO MOLEX INCORPORATED AND SHOULD NOT BE USED WITHOUT WRITTEN PERMISSION				

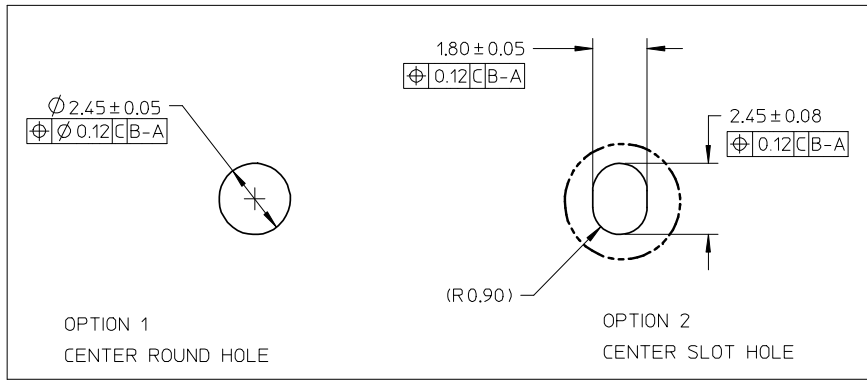
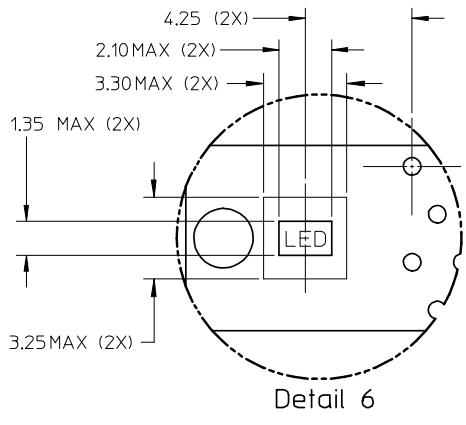

(SEE RECOMMENDED THICKNESS IN TABLE)
RECOMMENDED PCB LAYOUT
CONNECTOR SIDE

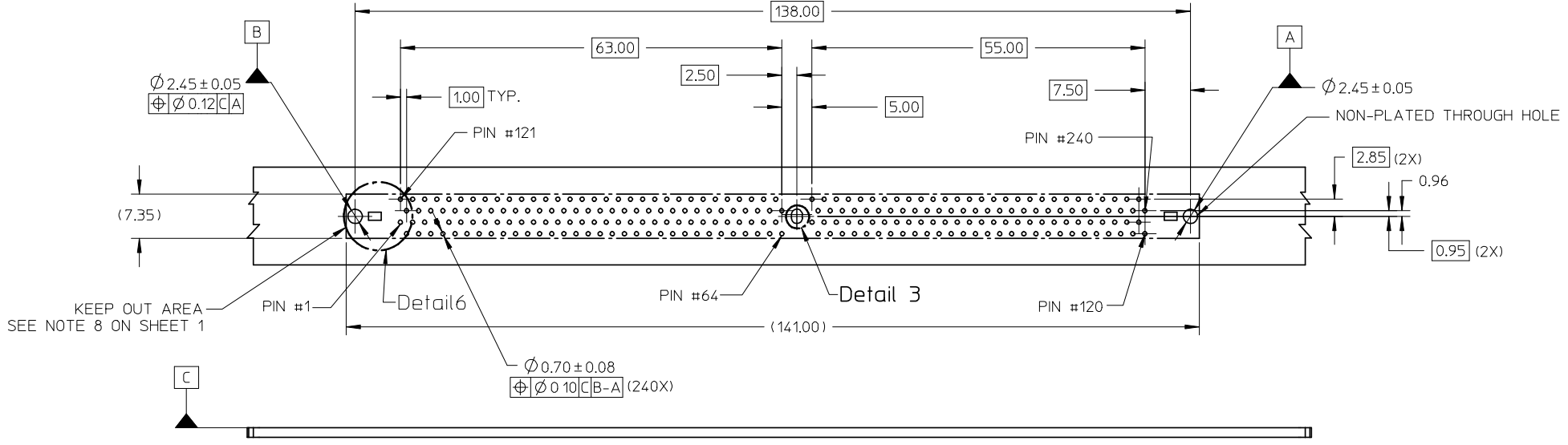

ADD NOTE @SHT 4 C1
EC NO: S2008-1044
DRW:CMTEO 2008/05/15
CHKD:CGTAN 2008/05/15
APPR:SHLENI 2008/05/15

QUALITY SYMBOLS	DESCRIPTION
$\nabla = 0$	
$\square = 0$	

GENERAL TOLERANCES (UNLESS SPECIFIED)	
mm	INCH
4 PLACES ± ---	± ---
3 PLACES ± ---	± ---
2 PLACES ± 0.20	± ---
1 PLACE ± ---	± ---
ANGULAR ± 5 °	
DRAFT WHERE APPLICABLE MUST REMAIN WITHIN DIMENSIONS	





DIMENSION STYLE	
MM ONLY	
DRAWN BY	DATE
CGOH	2002/05/09
CHECKED BY	DATE
DSOH	2002/07/22
APPROVED BY	DATE
SKTOH	2002/07/23
MATERIAL NO.	
SEE TABLE	

SCALE	DESIGN UNITS	THIRD ANGLE PROJECTION
NTS	METRIC	
TITLE		
DDR2 DIMM, 100MM PITCH 240 CKTS (FORKLOCK VERSION)		
MOLEX INCORPORATED		
DOCUMENT NO.		SHEET NO.
SD-87705-001		4 OF 6
THIS DRAWING CONTAINS INFORMATION THAT IS PROPRIETARY TO MOLEX INCORPORATED AND SHOULD NOT BE USED WITHOUT WRITTEN PERMISSION		

PART NO.	KEY POS.	DIM 'P'	RECOMMENDED PCB THICKNESS	PLATING OPTION	LATCH COLOR
87705-0021	CENTER (1.8V)	2.67	1.57	0.38µM / 15 µIN MIN. GOLD ON CONTACT, 2.54µM/ 100µIN MIN. TIN ON SOLDERTAILS, 1.27µM/ 50µIN MIN. NICKEL UNDERPLATE	NATURAL
87705-1021		3.18	2.36		
87705-1053		3.66			
87705-0031		2.67	1.57	0.03µM / 1 µIN MIN. GOLD ON CONTACT, 2.54µM/ 100µIN MIN. TIN ON SOLDERTAILS, 1.27µM/ 50µIN MIN. NICKEL UNDERPLATE	
87705-1031		3.18	2.36		
87705-0051		2.67	1.57	0.76µM / 30 µIN MIN. GOLD ON CONTACT, 2.54µM/ 100µIN MIN. TIN ON SOLDERTAILS, 1.27µM/ 50µIN MIN. NICKEL UNDERPLATE	
87705-1051		3.18	2.36		

ADD NOTE @SHT 4 C1 EC NO: S2008-1044 DRWN:CMTEO 2008/05/15 CHKD:CGTAN 2008/05/15 APPR:SHLENI 2008/05/15	DESCRIPTION REV	QUALITY SYMBOLS	GENERAL TOLERANCES (UNLESS SPECIFIED)	DIMENSION STYLE	SCALE	DESIGN UNITS	THIRD ANGLE PROJECTION	
		▽=0 ◻=0	mm INCH 4 PLACES ± --- ± --- 3 PLACES ± --- ± --- 2 PLACES ± 0.20 ± --- 1 PLACE ± --- ± --- ANGULAR ± 5 °	MM ONLY	NTS	METRIC	☉ ◻ THIRD ANGLE PROJECTION	
			DRAFT WHERE APPLICABLE MUST REMAIN WITHIN DIMENSIONS	DRAWN BY: CGOH DATE: 2002/05/09 CHECKED BY: DS0H DATE: 2002/07/22 APPROVED BY: SKTOH DATE: 2002/07/23	TITLE	DDR2 DIMM, 100MM PITCH 240 CKTS (FORKLOCK VERSION)		
		D1		SEE TABLE	MATERIAL NO. DOCUMENT NO.	MOLEX INCORPORATED SD-87705-001		SHEET NO. 5 OF 6

PART NO.	KEY POS.	DIM 'P'	RECOMMENDED PCB THICKNESS	PLATING OPTION	LATCH COLOR
87705-5051	CENTER (1.8V)	2.67	1.57	0.76µM / 30 µIN MIN. GOLD ON CONTACT, 2.54µM/ 100µIN MIN. TIN ON SOLDERTAILS, 1.27µM/ 50µIN MIN. NICKEL UNDERPLATE	CLEAR
87705-5151		3.18	2.36		
87705-6151		3.18	2.36	0.38µM / 15 µIN MIN. GOLD ON CONTACT, 2.54µM/ 100µIN MIN. TIN ON SOLDERTAILS, 1.27µM/ 50µIN MIN. NICKEL UNDERPLATE	
87705-9101		2.67	1.57	0.38µM / 15 µIN MIN. GOLD ON CONTACT, 2.54µM/ 100µIN MIN. TIN ON SOLDERTAILS, 1.27µM/ 50µIN MIN. NICKEL UNDERPLATE	

ADD NOTE @SHT 4 C1 EC NO: S2008-1044 DRWN:CMTEO 2008/05/15 CHKD:CGTAN 2008/05/15 APPR:SHLENI 2008/05/15	DESCRIPTION REV	QUALITY SYMBOLS	GENERAL TOLERANCES (UNLESS SPECIFIED)	DIMENSION STYLE	SCALE	DESIGN UNITS	THIRD ANGLE PROJECTION
		 = 0  = 0	mm INCH 4 PLACES ± --- ± --- 3 PLACES ± --- ± --- 2 PLACES ± 0.20 ± --- 1 PLACE ± --- ± --- ANGULAR ± 5 °	MM ONLY	NTS	METRIC	
			DRAFT WHERE APPLICABLE MUST REMAIN WITHIN DIMENSIONS	DRAWN BY: CGOH DATE: 2002/05/09 CHECKED BY: DATE: APPROVED BY: SKTOH DATE: 2002/07/23 MATERIAL NO. DOCUMENT NO.	TITLE: DDR2 DIMM, 100MM PITCH 240 CKTS (FORKLOCK VERSION)  MOLEX INCORPORATED	SHEET NO. 6 OF 6	
		D1		SEE TABLE	SD-87705-001		