

**ILA1185A**

**TRIAC PHASE ANGLE CONTROLLER**

The ILA1185A generates controlled triac triggering pulses and allows tachless speed stabilization of universal motors by an integrated positive feedback function. Typical applications are power hand tools, vacuum cleaners, mixers, light dimmer and other small appliances.

- Supply Power Obtained from AC Line
- Can be used with 220 V/50 Hz or 110 V/60 Hz
- Low Count/Cost External Components
- Optimum Triac Firing (2nd and 3rd Quadrants)
- Repetitive Trigger Pulses when Triac Current is Interrupted
- by Motor Brush Bounce
- Triac Current Sensing to Allow Inductive Loads
- Programmable Soft-Start
- Power Failure Detection and General Circuit Reset
- Low Power Consumption; 6.0 mA

Pin Connection

$V_{EE}$	1	14	$V_{CC}$
Gate trigger	2	13	Soft start
NC	3	12	Firing Angle Set
Ramp Generator	4	11	NC
NC	5	10	Bias Current
Current Cense	6	9	Feedback Input
Voltage Cense	7	8	Integration Cap

Figure 1. Representative Block Diagram

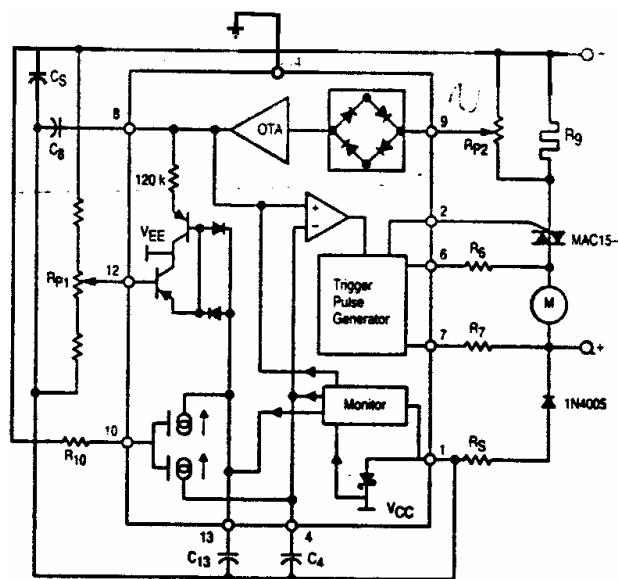

**MAXIMUM RATINGS** (voltages are referenced to Pin 14 (ground) unless other noted)

Rating	Symbol	Value	Unit
Maximum Voltage Range per Listed Pin Pins 3, 5, 11 (not connected) Pins 4, 8, 13 Pin 2 Maximum Positive Voltage (No minimum value allowed; see current ratings)	$V_{pin}$  $V_{pin12}$ $V_{pin1}$	-20 to +20 - $V_{CC}$ to 0 -3.0 to +3.0 0 0.5	V
Maximum Current per Listed pin Pin 1 Pin 6 and 7 Pin 9 Pin 10 Pin 12	$I_{pin}$	±20 ±2.0 ±0.5 ±300 -500	mA mA mA µA µA
Maximum Power Dissipation ( $T_A=25^\circ\text{C}$ )	$P_D$	250	mW
Maximum Thermal Resistance, Junction-to-Ambient	$R_{\theta JA}$	100	°C/W
Operating Ambient Temperature Range	$T_A$	0 to + 70	°C
Storage Temperature Range	$T_{stg}$	-55 to <+ 125	°C

**ELECTRICAL CHARACTERISTICS** ( $T_A=25^\circ\text{C}$ , voltages are referenced to Pin 14 (ground) unless other noted.)

Characteristics	Symbol	Min	Typ	Max	Unit
Power Supply Zener Regulated Voltage, ( $V_{pin1}$ ) $I_{pin1} = 2.0$ mA	$-V_{CC}$	-9.6	-8.6	-7.6	V
Circuit Current Consumption. $I_{pin1}$ $V_{pin1} = -6.0\text{V}, I_{pin2} = 0\text{A}$	$-I_{CC}$	-2.0	-1.0	-	mA
Monitoring Enable Supply Voltage ( $V_{EN}$ )	$V_{pin1EN}$	$V_{CC}+0.2$		$V_{CC}+0.5$	V
Monitoring Disable Supply Voltage ( $V_{DIS}$ )	$V_{pin1DIS}$	$V_{EN}+0.12$		$V_{EN}+0.3$	V
Phase Set Control Voltage Static Offset $V_{pin3} - V_{pin12}$	$V_{off}$	1.2	-	2.0	V
Pin 12 Input Bias Current	$I_{pin12}$	-200	-	0	nA
$V_{pin4} - V_{pin12}$ Residual Offset		-	180	-	mV
Soft-Start Capacitor Charging Current $R_{pin10} = 100$ kΩ $V_{pin13}$ from $-V_{CC}$ to $-3.0\text{V}$	$I_{pin13}$	-17'	-14	-11	µA
Sawtooth Generator Sawtooth Capacitor Discharge Current $R_{10} = 100$ kΩ, $V_{pin4}$ from $-2.0$ to $-6.0\text{V}$	$I_{pin4}$	67	70	73	µA
Capacitor Charging Current	$I_{pin4}$	-10	-	-1.5	mA
Sawtooth -High Voltage ( $V_{pin4}$ )	$V_{HTH}$	-2.5	-1.6	-1.0	V
Sawtooth Minimum Low Voltage ( $V_{pin4}$ )	$V_{LTH}$	-	-7.1	-	V

**ELECTRICAL CHARACTERISTICS** ( $T_A = 25^\circ\text{C}$ , voltages are referenced to Pin 14 (ground) unless other noted.)

Characteristics	Symbol	Min	Typ	Max	Unit
Positive Feedback					
Pin 9 Input Bias Current, $V_{\text{pin9}} = 0$	$I_{\text{pin9}}$	-	$2 \times I_{\text{pin10}}$	-	V
Programming pin voltage related to Pin 1	$V_{\text{pin10}}$	1.0	1.25	1.5	
Transfer Function Gain $\Delta V_{\text{pin8}} / \Delta V_{\text{pin9}}$					
$R_{10} = 100 \text{ k}\Omega, \Delta V_{\text{pin9}} = 50 \text{ mV}$	A	-	75	-	
$R_{10} = 270 \text{ k}\Omega, \Delta V_{\text{pin9}} = 50 \text{ mV}$	A	-	36	-	
Pin 8 Output Internal Impedance	$Z_{\text{pin8}}$	-	120	-	$\text{k}\Omega$
Trigger Pulse Generator					
Output Current (Sink) $V_{\text{pin2}} = 0\text{V}$	$I_{\text{pin2}}$	60	-	80	mA
Output Leakage Current $V_{\text{pin2}} = +2.0\text{V}$		-	-	4.0	$\mu\text{A}$
Output Pulse Width	$t_p$	-	55	-	$\mu\text{s}$
$C_4 = 47\text{nF}, R_{10} = 270\text{k}\Omega$					
Output Pulse Repetition Period	t	-	420	-4	$\mu\text{s}$
$C_4 = 47\text{nF}, R_{10} = 270 \text{ k}\Omega$					
Current Synchronization Threshold Levels $I_{\text{pin6}}, I_{\text{pin7}}$	$I_{\text{sync}}$	-40	-	+40	$\mu\text{A}$

**PIN FUNCTION DESCRIPTION**

Pin No.	Function	Description
1	$V_{EE}$	This pin is the negative supply for the chip and clamped at -8.6 V by an internal zener.
2	Gate Trigger Pulse	This pin supplies - 1.0V triac trigger pulse at twice the line frequency.
3	NC	Not connected.
4	Ramp Generator	The value of the capacitor at this pin determines the slope of the ramp.
5	NC	Not connected.
6	Current Sense	This pin senses if the triac is on, and if so, will disable the gate trigger pulse.
7	Voltage Sense	The internal timing of the chip is set by the frequency of the voltage at this pin
8	Integration Capacitor	This pin is the output of the feedback and the variation in voltage is averaged out by the capacitor.
9	Feedback Input	The change in load current is detected by the change in voltage across R9.
10	Current Program	The bias current for the circuit is determined by the resistor value at this pin.
11	NC	Not connected.
12	Phase Angle Set	The voltage at this pin sets the no-load firing angle.
13	Soft-Start	The firing angle is slowly increased from $180^\circ$ to the set value of Pin 12.
14	$V_{CC}$	Ground

**N SUFFIX PLASTIC DIP  
(MS - 001AA)**

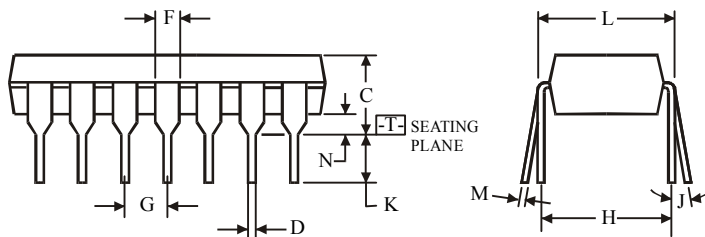
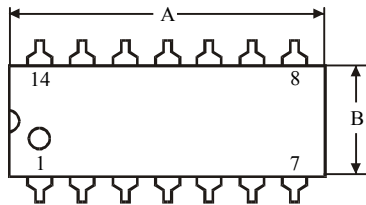
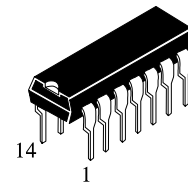

$\oplus 0.25 (0.010) \text{ (M) T}$

**NOTES:**

- Dimensions "A", "B" do not include mold flash or protrusions.  
Maximum mold flash or protrusions 0.25 mm (0.010) per side.

Symbol	Dimension, mm	
	MIN	MAX
A	18.67	19.69
B	6.1	7.11
C		5.33
D	0.36	0.56
F	1.14	1.78
G	2.54	
H	7.62	
J	0°	10°
K	2.92	3.81
L	7.62	8.26
M	0.2	0.36
N	0.38	

**D SUFFIX SOIC  
(MS - 012AB)**

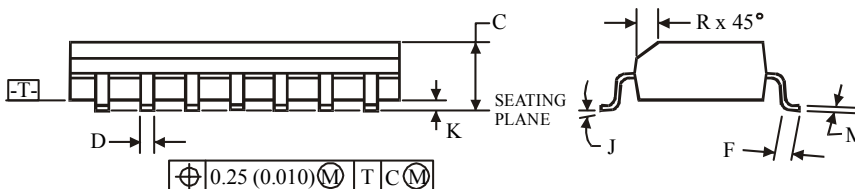
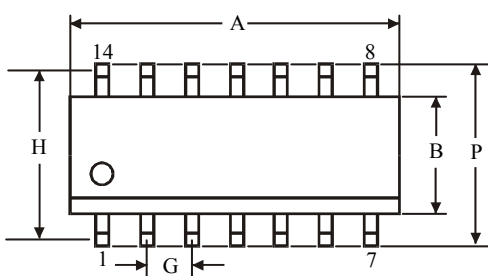
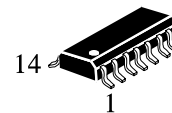

$\oplus 0.25 (0.010) \text{ (M) T C (M)}$

**NOTES:**

- Dimensions A and B do not include mold flash or protrusion.
- Maximum mold flash or protrusion 0.15 mm (0.006) per side for A; for B - 0.25 mm (0.010) per side.

Symbol	Dimension, mm	
	MIN	MAX
A	8.55	8.75
B	3.8	4
C	1.35	1.75
D	0.33	0.51
F	0.4	1.27
G	1.27	
H	5.27	
J	0°	8°
K	0.1	0.25
M	0.19	0.25
P	5.8	6.2
R	0.25	0.5