

Input voltage up to 144 V DC
Single output of 12...48 V DC
No input to output isolation

- High efficiency up to 95%
- Extremely wide input voltage range
- Very good dynamic properties
- Input undervoltage lock-out
- External output voltage adjustment and inhibit
- Two temperature ranges
- Continuous no-load and short-circuit proof
- No derating

Safety according to IEC/EN 60950



Summary

The PSA series of positive switching regulators is designed as power supply modules for electronic systems. Their major advantages include a high level of efficiency that remains virtually constant over the entire input range, high reliability, low ripple and excellent dynamic response.

Modules with input voltages up to 144 V are specially designed for battery-driven mobile applications. The case design allows operation at nominal load up to 71 °C without additional cooling.

Type Survey and Key Data

Table 1: Type survey

Output voltage $U_{o\ nom}$ [V DC]	Output current $I_{o\ nom}$ [A]	Input voltage range U_i [V DC] ¹	Input voltage $U_{i\ nom}$ [V DC]	Efficiency ²		Type designation	Options
				η_{min} [%]	η_{typ} [%]		
12	1.5	18...144	60	86	87	PSA 121.5-7iR	-9, P, Y
15	1.5	22...144	60	87	89	PSA 151.5-7iR	
24	1.5	31...144	60	92	93	PSA 241.5-7iR	
36	1.2	44...144	80	94	95	PSA 361-7iR	
48	1.0	58...144	80	94	95	PSA 481-7iR	

¹ Surges up to 156 V for 2 s. See also: *Electrical Input Data: $\Delta U_{i\ min}$* .

² Efficiency at $U_{i\ nom}$ and $I_{o\ nom}$.

Non standard input/output configurations or special custom adaptations are available on request.
See also: *Commercial Information: Inquiry Form for Customized Power Supply*.

Table of Contents

	Page	Page	
Summary	1	Electromagnetic Compatibility (EMC)	8
Type Survey and Key Data	1	Immunity to Environmental Conditions	9
Type Key	2	Mechanical Data	10
Functional Description	2	Safety and Installation Instructions	10
Electrical Input Data	3	Description of Options	12
Electrical Output Data	4	Accessories	12
Auxiliary Functions	6	EC Declaration of Conformity	13

Type Key and Product Marking

Positive switching regulator in case A01	PSA
Nominal output voltage in volt	12...48
Nominal output current in ampere	1...1.5
Operational ambient temperature range T_A	
-25...71°C	-7
-40...71°C (option)	-9
Inhibit input	i
Control input for output voltage adjustment ¹	R
Potentiometer ¹ (option)	P
PCB soldering pins 0.5 ∞ 1.0 mm (option)	Y

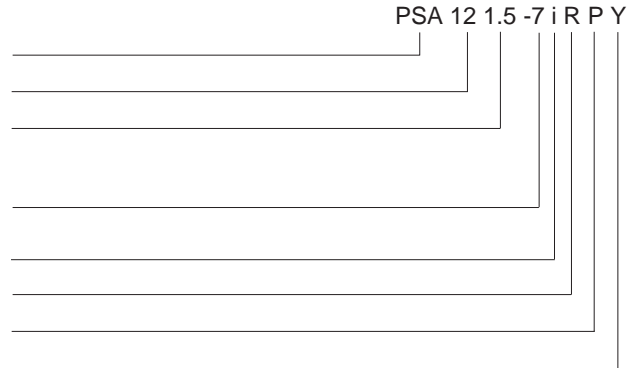

¹ R-Control excludes option P and vice versa.

Example: PSA 121.5-7iPY = A positive switching regulator with a 12 V, 1.5 A output, ambient temperature range of -25...71°C, inhibit input, potentiometer and small soldering pins.

Functional Description

The switching regulators are using the buck converter topology. See also: *Technical Information: Topologies*. The input is not electrically isolated from the output. During the on period of the switching transistor, current is transferred to the output and energy is stored in the output choke in the form of flux. During the off period, this energy forces the current to continue flowing through the output, to the load and back through the freewheeling diode. Regulation is accomplished by varying the on to off duty ratio of the power switch.

These regulators are ideal for a wide range of applications, where input to output isolation is not necessary, or where already provided by an external front end (e.g. a transformer with rectifier). To optimise customer's needs, additional options and accessories are available.

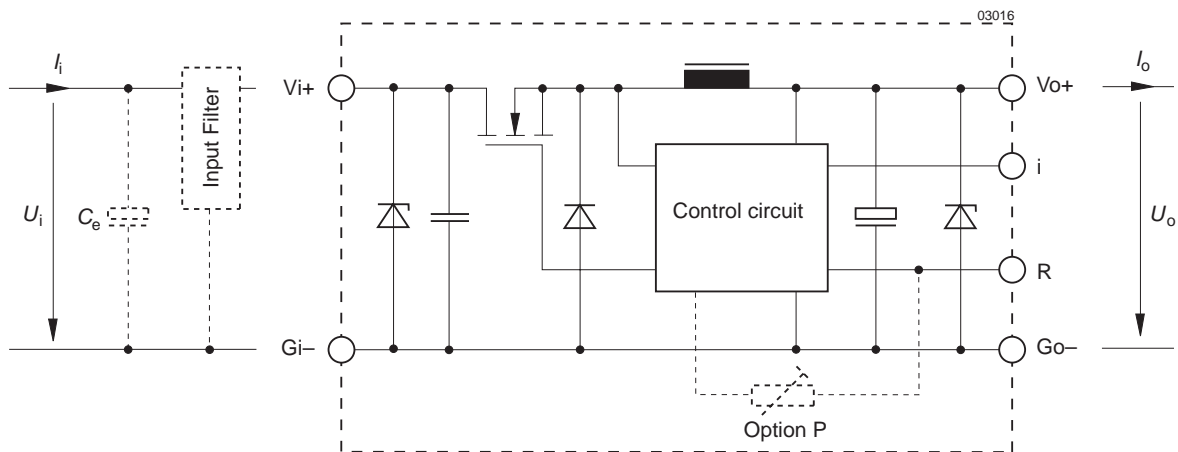

Fig. 1
Block diagram

Electrical Input Data

General Conditions: $T_A = 25^\circ\text{C}$, unless T_C is specified

Table 2a: Input data

Input			PSA 121.5			PSA 151.5			PSA 241.5			Unit
Characteristics	Conditions		min	typ	max	min	typ	max	min	typ	max	
U_i	Operating input voltage ¹	$I_o = 0 \dots I_{o \text{ nom}}$ $T_C \text{ min} \dots T_C \text{ max}$	18		144	22		144	31		144	V DC
$\Delta U_{i o \text{ min}}$	Min. diff. voltage $U_i - U_o$				6			7			7	
$U_{i o}$	Undervoltage lock-out				12			18			22	
$I_{i o}$	No load input current	$I_o = 0, U_i \text{ min} \dots U_i \text{ max}$			20			20			20	mA
$I_{\text{inr p}}$	Peak value of inrush current	$U_i \text{ nom}$			150			150			150	A
$t_{\text{inr r}}$	Rise time				2.5			2.5			2.5	μs
$t_{\text{inr h}}$	Time to half-value				15			15			15	
$U_{i \text{ RFI}}$	Input RFI level, EN 55011/22 0.15...30 MHz ²	$U_i \text{ nom}, I_o \text{ nom}$			B			B			B	

Table 2b: Input data

Input			PSA 361			PSA 481			Unit
Characteristics	Conditions		min	typ	max	min	typ	max	
U_i	Operating input voltage ¹	$I_o = 0 \dots I_{o \text{ nom}}$ $T_C \text{ min} \dots T_C \text{ max}$	44		144	58		144	V DC
$\Delta U_{i o \text{ min}}$	Min. diff. voltage $U_i - U_o$				8			10	
$U_{i o}$	Undervoltage lock-out				31			44	
$I_{i o}$	No load input current	$I_o = 0, U_i \text{ min} \dots U_i \text{ max}$			25			25	mA
$I_{\text{inr p}}$	Peak value of inrush current	$U_i \text{ nom}$			150			150	A
$t_{\text{inr r}}$	Rise time				2.5			2.5	μs
$t_{\text{inr h}}$	Time to half-value				15			15	
$U_{i \text{ RFI}}$	Input RFI level, EN 55011/22 0.15...30 MHz ²	$U_i \text{ nom}, I_o \text{ nom}$			B			B	

¹ Surges up to 156 V for 2 s (complying to LES-DB standard for 110 V - batteries).

² With input filter FP 144 (See :Accessories) and $2 \times 3.3 \mu\text{F}/250 \text{ V}$ MKT-capacitors.

External Input Circuitry

The sum of the lengths of the supply lines to the source or to the nearest capacitor $\geq 100 \mu\text{F}$ or to the nearest external input filter which includes such a capacitor (a + b) should not exceed 2.0 m (3.0 m twisted). An external input filter (FP 144, see Accessories) is recommended in order to prevent power line oscillations and reduce superimposed interference voltages. See also: *Technical Information*.

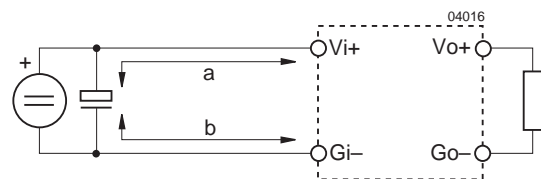

Fig. 2
Switching regulator with long supply lines.

Electrical Output Data

General Conditions:

- $T_A = +25^\circ\text{C}$, unless T_C is specified
- With R or option P, output voltage $U_o = U_{o\text{ nom}}$ at $I_{o\text{ nom}}$

Table 3a: Output data

Output			PSA 121.5			PSA 151.5			PSA 241.5			Unit
Characteristics		Conditions	min	typ	max	min	typ	max	min	typ	max	
U_o	Output voltage		$U_{i\text{ nom}}, I_{o\text{ nom}}$			11.93	12.07	14.91	15.09	23.86	24.14	V
I_o	Output current ¹		$U_{i\text{ min}} \dots U_{i\text{ max}}$			0	1.5	0	1.5	0	1.5	A
I_{oL}	Output current limitation response ¹		$T_C\text{ min} \dots T_C\text{ max}$			1.5	1.9	1.5	1.9	1.5	1.9	
u_o	Output voltage noise	Switching freq.	$U_{i\text{ nom}}, I_{o\text{ nom}}$			20	35	25	45	45	90	mV _{pp}
		Total	IEC/EN 61204 ² BW = 20 MHz			24	39	29	49	50	95	
ΔU_{oU}	Static line regulation		$U_{i\text{ min}} \dots U_{i\text{ max}}, I_{o\text{ nom}}$			40	80	40	80	40	80	mV
ΔU_{oI}	Static load regulation		$U_{i\text{ nom}}, I_o = 0 \dots I_{o\text{ nom}}$			20	50	20	50	30	60	
u_{od}	Dynamic load regulation	Voltage deviat.	$U_{i\text{ nom}}$			50		50		50		μs
t_d		Recovery time	$I_{o\text{ nom}} \leftrightarrow \frac{1}{3} I_{o\text{ nom}}$ IEC/EN 61204 ²			50		50		60		
α_{Uo}	Temperature coefficient		$U_{i\text{ min}} \dots U_{i\text{ max}}$			± 2			± 2			mV/K
	$\Delta U_o / \Delta T_C (T_C\text{ min} \dots T_C\text{ max})$		$I_o = 0 \dots I_{o\text{ nom}}$			± 0.02			± 0.02			

Table 3b: Output data

Output			PSA 361			PSA 481			Unit			
Characteristics		Conditions	min	typ	max	min	typ	max				
U_o	Output voltage		$U_{i\text{ nom}}, I_{o\text{ nom}}$			35.78	36.22	47.71	48.29	V		
I_o	Output current ¹		$U_{i\text{ min}} \dots U_{i\text{ max}}$			0	1.2	0	1.0	A		
I_{oL}	Output current limitation response ¹		$T_C\text{ min} \dots T_C\text{ max}$			1.2	1.5	1.0	1.3			
u_o	Output voltage noise	Switching freq.	$U_{i\text{ nom}}, I_{o\text{ nom}}$			45	90	50	120	mV _{pp}		
		Total	IEC/EN 61204 ² BW = 20 MHz			50	95	55	125			
ΔU_{oU}	Static line regulation		$U_{i\text{ min}} \dots U_{i\text{ max}}, I_{o\text{ nom}}$			80	120	90	120	mV		
ΔU_{oI}	Static load regulation		$U_{i\text{ nom}}, I_o = 0 \dots I_{o\text{ nom}}$			40	80	60	100			
u_{od}	Dynamic load regulation	Voltage deviat.	$U_{i\text{ nom}}$			60		60		μs		
t_d		Recovery time	$I_{o\text{ nom}} \leftrightarrow \frac{1}{3} I_{o\text{ nom}}$ IEC/EN 61204 ²			60		60				
α_{Uo}	Temperature coefficient		$U_{i\text{ min}} \dots U_{i\text{ max}}$			± 5			± 6			mV/K
	$\Delta U_o / \Delta T_C (T_C\text{ min} \dots T_C\text{ max})$		$I_o = 0 \dots I_{o\text{ nom}}$			± 0.02			± 0.02			

¹ See also: *Thermal Considerations*.

² See: *Technical Information: Measuring and Testing*.

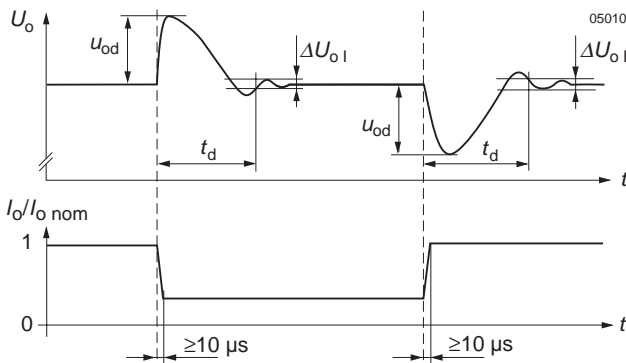

Fig. 3
Dynamic load regulation.

Thermal Considerations

When a switching regulator is located in free, quasi-stationary air (convection cooling) at a temperature $T_A = 71^\circ\text{C}$ and is operated at its nominal output current $I_{o,nom}$, the case temperature T_C will not exceed 95°C after the warm-up phase, measured at the *Measuring point of case temperature* T_C (see: *Mechanical Data*).

Under practical operating conditions, the ambient temperature T_A may exceed 71°C , provided additional measures (heat sink, fan, etc.) are taken to ensure that the case temperature T_C does not exceed its maximum value of 95°C .

Example: Sufficient forced cooling allows $T_{A,max} = 85^\circ\text{C}$. A simple check of the case temperature T_C ($T_C \leq 95^\circ\text{C}$) at full load ensures correct operation of the system.

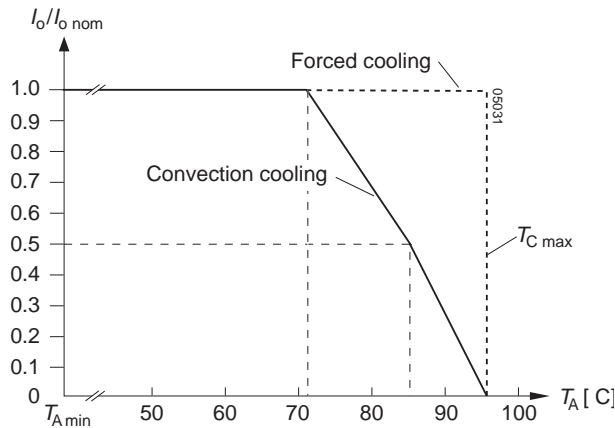

Fig. 4
Output current derating versus temperature

Output Protection

A voltage suppressor diode which in worst case conditions fails into a short circuit, protects the output against an internally generated overvoltage. Such an overvoltage could occur due to a failure of either the control circuit or the switching transistor. The output protection is not designed to withstand externally applied overvoltages. The user should ensure that systems with Power-One power supplies, in the event of a failure, do not result in an unsafe condition (fail-safe).

Parallel and Series Connection

Outputs of equal nominal voltages can be parallel-connected. However, the use of a single unit with higher output power, because of its power dissipation, is always a better solution.

In parallel-connected operation, one or several outputs may operate continuously at their current limit knee-point, which will cause an increase of the heat generation. Consequently, the max. ambient temperature should be reduced by 10 K.

Outputs can be series-connected with any other module. In series-connection the maximum output current is limited by the lowest current limitation. Electrically separated source voltages are needed for each module!

Short Circuit Behaviour

A constant current limitation circuit holds the output current almost constant whenever an overload or a short circuit is applied to the regulator's output. It acts self-protecting and recovers – in contrary to the fold back method – automatically after removal of the overload or short circuit condition.

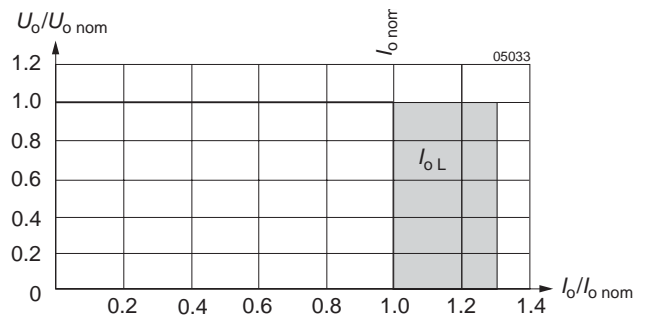

Fig. 5
Overload, short-circuit behaviour U_o versus I_o .

Auxiliary Functions

i Inhibit for Remote On and Off

Note: With open i-input, output is enabled ($U_o = \text{on}$)

The inhibit input allows the switching regulator output to be disabled via a control signal. In systems with several units, this feature can be used, for example, to control the activation sequence of the regulators by a logic signal (TTL, CMOS, etc.). An output voltage overshoot will not occur when switching on or off.

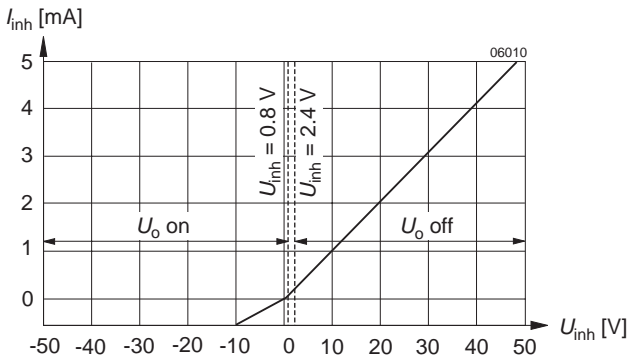

Fig. 6
Typical inhibit current I_{inh} versus inhibit voltage U_{inh}

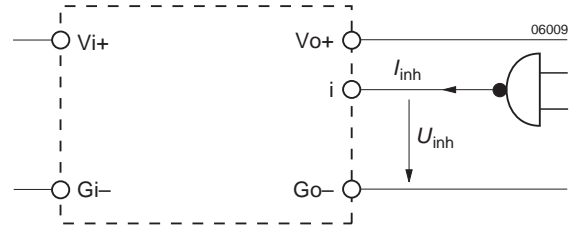

Fig. 7
Definition of I_{inh} and U_{inh}

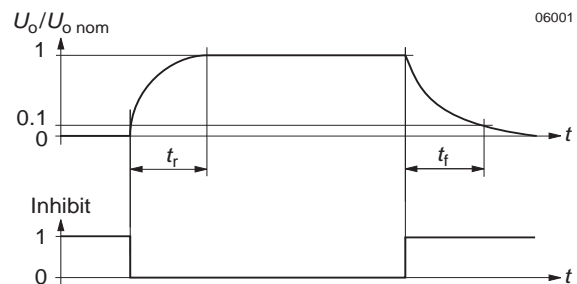

Fig. 8
Output response as a function of inhibit signal

Table 4: Inhibit characteristics

Characteristics		Conditions	min	typ	max	Unit
U_{inh}	Inhibit input voltage to keep regulator output voltage...	$U_o = \text{on}$	-10		+0.8	V DC
		$U_o = \text{off}$	+2.4		+50	
t_r	Switch-on time after inhibit command	$U_i = U_{i \text{ nom}}$		2		ms
t_f	Switch-off time after inhibit command	$R_L = U_o \text{ nom} / I_o \text{ nom}$		4		
$I_{i \text{ inh}}$	Input current when inhibited	$U_i = U_{i \text{ nom}}$		10		mA

R Control for Output Voltage Adjustment

Note: With open R input, $U_o \approx U_{o \text{ nom}}$. R excludes option P. The output voltage U_o can either be adjusted with an external voltage (U_{ext}) or with an external resistor (R_1 or R_2). The adjustment range is 0...108% of $U_{o \text{ nom}}$. The minimum differential voltage $\Delta U_{o \text{ min}}$ between input and output (see: *Electrical Input Data*) should be maintained. Under-voltage lock-out = Minimum input voltage.

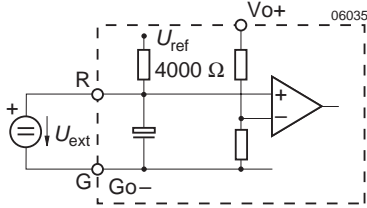

Fig. 9
Voltage adjustment with U_{ext} between R and Go-

a) $U_o = 0...108\% U_{o \text{ nom}}$, using U_{ext} between R and Go-:

$$U_{\text{ext}} \approx 2.5 \text{ V} \cdot \frac{U_o}{U_{o \text{ nom}}} \quad U_o \approx U_{o \text{ nom}} \cdot \frac{U_{\text{ext}}}{2.5 \text{ V}}$$

Caution: To prevent damage U_{ext} should not exceed 20 V, nor be negative and R_2 should never be less than 47 k Ω .

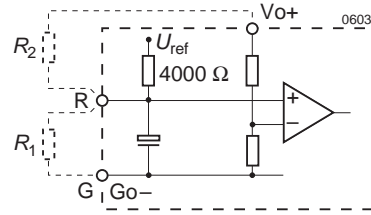

Fig. 10
Voltage adjustment with external resistor R_1 or R_2

b) $U_o = 0...100\% U_{o \text{ nom}}$, using R_1 between R and Go-:

$$R_1 \approx \frac{4000 \Omega \cdot U_o}{U_{o \text{ nom}} - U_o} \quad U_o \approx \frac{U_{o \text{ nom}} \cdot R_1}{R_1 + 4000 \Omega}$$

c) $U_o = U_{o \text{ nom}}...U_{o \text{ max}}$, using R_2 between R and Vo+:

$$U_{o \text{ max}} = U_{o \text{ nom}} + 8\%$$

$$R_2 \approx \frac{4000 \Omega \cdot U_o \cdot (U_{o \text{ nom}} - 2.5 \text{ V})}{2.5 \text{ V} \cdot (U_o - U_{o \text{ nom}})}$$

$$U_o \approx \frac{U_{o \text{ nom}} \cdot 2.5 \text{ V} \cdot R_2}{2.5 \text{ V} \cdot (R_2 + 4000 \Omega) - U_{o \text{ nom}} \cdot 4000 \Omega}$$

LED Output Voltage Indicator

A yellow output indicator LED shines when the output voltage is higher than approx. 3 V.

Electromagnetic Compatibility (EMC)

Electromagnetic Immunity

General condition: Case not earthed.

Table 5: Immunity type tests

Phenomenon	Standard ¹	Class Level	Coupling mode ²	Value applied	Waveform	Source Imped.	Test procedure	In oper.	Per-form. ³
Voltage surge	IEC 60571-1		i/c, +i/-i	800 V _p	100 μs	100 Ω	1 pos. and 1 neg. voltage surge per coupling mode	yes	B
				1500 V _p	50 μs				
				3000 V _p	5 μs				
				4000 V _p	1 μs				
				7000 V _p	100 ns				
Electrostatic discharge	IEC/EN 61000-4-2	4	contact discharge to case	8000 V _p	1/50 ns	330 Ω	10 positive and 10 negative discharges	yes	B ⁴
Electromagnetic field	IEC/EN 61000-4-3	3	antenna	10 V/m	AM 80% 1 kHz		26...1000 MHz	yes	A
Electrical fast transient/burst	IEC/EN 61000-4-4	3	i/c, +i/-i	2000 V _p	bursts of 5/50 ns 5 kHz rep. rate transients with 15 ms burst duration and a 300 ms period	50 Ω	1 min positive 1 min negative bursts per coupling mode	yes	A ⁴
		4		4000 V _p					B ⁴
Surge	IEC/EN 61000-4-5	2	i/c	1000 V _p	1.2/50 μs	12 Ω	5 pos. and 5 neg. surges per coupling mode	yes	A ⁴
			+i/-i	500 V _p		2 Ω			
Conducted disturbances	IEC/EN 61000-4-6	3	i, o, signal wires	140 dBμV (10 V _{rms})	AM 80% 1 kHz	150 Ω	0.15...80 MHz	yes	A

¹ For related and previous standards see: *Technical Information: Safety & EMC.*

² i = input, o = output, c = case.

³ A = Normal operation, no deviation from specifications, B = Normal operation, temporary deviation from specs possible.

⁴ External input filter FP 144 necessary.

Electromagnetic Emission

For emission levels refer to: *Electrical Input Data.*

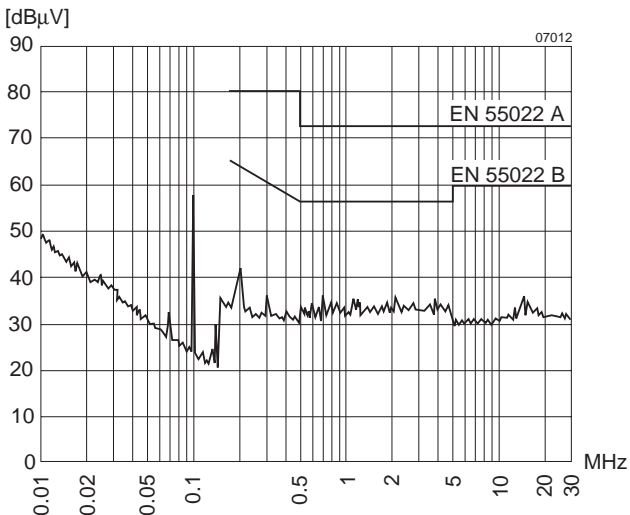

Fig. 11
Typical disturbance voltage (quasi-peak) at the input according to EN 55011/22 measured at $U_{I\text{ nom}}$ and $I_{o\text{ nom}}$.

Immunity to Environmental Conditions

Table 6: Mechanical stress

Test Method		Standard	Test Conditions		Status
Ca	Damp heat steady state	IEC/DIN IEC 60068-2-3 MIL-STD-810D section 507.2	Temperature: Relative humidity: Duration:	40 ±2 °C 93 +2/-3 % 56 days	Unit not operating
Ea	Shock (half-sinusoidal)	IEC/EN/DIN EN 60068-2-27 MIL-STD-810D section 516.3	Acceleration amplitude: Bump duration: Number of bumps:	100 g _n = 981 m/s ² 6 ms 18 (3 each direction)	Unit operating
Eb	Bump (half-sinusoidal)	IEC/EN/DIN EN 60068-2-29 MIL-STD-810D section 516.3	Acceleration amplitude: Bump duration: Number of bumps:	40 g _n = 392 m/s ² 6 ms 6000 (1000 each direction)	Unit operating
Fc	Vibration (sinusoidal)	IEC/EN/DIN EN 60068-2-6 MIL-STD-810D section 514.3	Acceleration amplitude: Frequency (1 Oct/min): Test duration:	0.7 mm (10...60 Hz) 10 g _n = 98 m/s ² (60...2000 Hz) 10...2000 Hz 7.5 h (2.5 h each axis)	Unit operating
Fda	Random vibration wide band Reproducibility high	IEC 60068-2-35 DIN 40046 part 23	Acceleration spectral density: Frequency band: Acceleration magnitude: Test duration:	0.2 g ² /Hz 20...500 Hz 9.8 g _{rms} 3 h (1 h each axis)	Unit operating
Kb	Salt mist, cyclic (sodium chloride NaCl solution)	IEC/EN/DIN IEC 60068-2-52	Concentration: Duration: Storage: Storage duration: Number of cycles:	5% (30°C) 2 h per cycle 40°C, 93% rel. humidity 22 h per cycle 3	Unit not operating

Table 7: Temperature specifications, valid for air pressure of 800...1200 hPa (800...1200 mbar)

Temperature		Conditions	Standard -7		Option -9		Unit
Characteristics	min		max	min	max		
T _A	Ambient temperature	Operational ¹	-25	71	-40	71	°C
T _C	Case temperature		-25	95	-40	95	
T _S	Storage temperature	Non operational	-40	100	-55	100	

¹ See *Thermal Considerations*

Table 8: MTBF and device hours

MTBF	Ground Benign	Ground Fixed		Ground Mobile	Device Hours ¹
MTBF acc. to MIL-HDBK-217F	T _C = 40°C	T _C = 40°C	T _C = 70°C	T _C = 50°C	5'100'000 h
	789'000	199'000 h	104'000 h	76'000 h	

¹ Statistical values, based on an average of 4300 working hours per year and in general field use.



Mechanical Data

Dimensions in mm. Tolerances ± 0.3 mm unless otherwise specified.

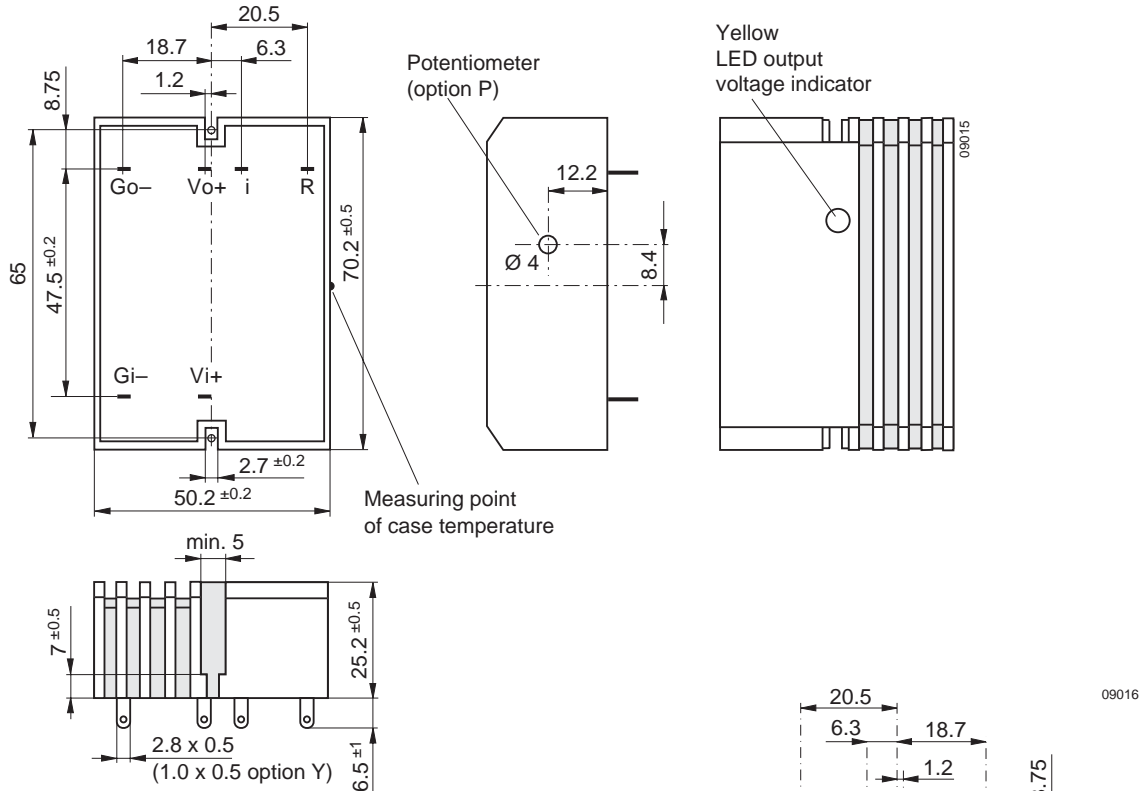

Fig. 12
Case A01, weight 100 g
Aluminium,
black finish and self cooling

Fig. 13
Case A01 hole locations for circuit board layout (component side view of PCB):

- - - = Space reserved for switching regulator
- a = 3.0 mm x 0.7 mm slot or \varnothing 3.0 mm, through plated for hand or machine soldering (fast on)
- a = \varnothing 1.3...1.5 mm with option Y pins

Safety and Installation Instructions

Installation Instruction

Installation of the switching regulators must strictly follow the national safety regulations in compliance with the enclosure, mounting, creepage, clearance, casualty, markings and segregation requirements of the end-use application.

Check for hazardous voltages before altering any connections. Connections can be made using fast-on or soldering technique.

The input and the output circuit are not separated. i.e. the negative path is internally interconnected!

The units should be connected to a secondary circuit.

Do not open the module.

Ensure that a unit failure (e.g. by an internal short-circuit) does not result in a hazardous condition. See also: *Safety of operator accessible output circuit.*

Cleaning Agents

In order to avoid possible damage, any penetration of cleaning fluids is to be prevented, since the power supplies are not hermetically sealed.

Protection Degree

The protection degree is IP 40, IP 20 with option P.

Isolation

Electric strength test voltage between input interconnected with output and case: 1500 V DC, 1 s.

This test is performed as factory test in accordance with IEC/EN 60950 and UL 1950 and should not be repeated in the field. Power-One will not honour any guarantee claims resulting from electric strength field tests.

Standards and Approvals

All switching regulators are UL recognized according to UL 1950 and EN 60950 and UL recognized for Canada to CAN/CSA C22.2 No. 234-M90.

The units have been evaluated for:

- Building in,
- Functional insulation from input to output and input/output to case,
- The use in an overvoltage category II environment,
- The use in a pollution degree 2 environment.

The switching regulators are subject to manufacturing surveillance in accordance with the above mentioned UL and CSA and with ISO 9001 standards.

Safety of Operator Accessible Output Circuit

If the output circuit of a switching regulator is operator-accessible, it shall be an SELV circuit according to IEC/EN 60950 related safety standards

The following table shows some possible installation configurations, compliance with which causes the output circuit of the switching regulator to be an SELV circuit according to IEC/EN 60950 up to a nominal output voltage of 30 V.

However, it is the sole responsibility of the installer or user to assure the compliance with the relevant and applicable safety regulations.

More information is given in: *Technical Information: Safety & EMC*.

Table 9: Safety concept leading to an SELV output circuit

Conditions	Front end			Switching regulator	Result
Supply voltage	Minimum required grade of isolation, to be provided by the AC-DC front end, including mains-supplied battery charger	Maximum DC output voltage from the front end ¹	Minimum required safety status of the front end output circuit	Measures to achieve the specified safety status of the output circuit	Safety status of the switching regulator output circuit
Battery supply, considered as secondary circuit	Double or Reinforced	≤60 V	SELV circuit	None	SELV circuit
		≥60 V	Earthed hazardous voltage secondary circuit ²	Input fuse ³ and non accessible case ⁵	Earthed SELV circuit
			Unearthed hazardous voltage secondary circuit ⁵	Input fuse ³ and unearthed, non accessible case ⁵	Unearthed SELV circuit
			Hazardous voltage secondary circuit	Input fuse ³ and earthed output circuit ⁴ and non accessible case ⁵	Earthed SELV circuit
Mains -250 V AC	Basic	≤60 V	Earthed SELV circuit ⁴	None	Earthed SELV circuit
			ELV circuit	Input fuse ³ and earthed output circuit ⁴ and non accessible case ⁵	
	≥60 V	Hazardous voltage secondary circuit	Input fuse ³ and earthed output circuit ⁴ and non accessible case ⁵		
		Double or reinforced	≤60 V	SELV circuit	
	≥60 V	Double or reinforced insulated unearthed hazardous voltage secondary circuit ⁵	Input fuse ³ and unearthed and non accessible case ⁵	Unearthed SELV circuit	

¹ The front end output voltage should match the specified input voltage range of the switching regulator.

² The conductor to the Gi- terminal of the switching regulator has to be connected to earth by the installer according to the relevant safety standard, e.g. IEC/EN 60950.

³ The installer shall provide an approved fuse (slow blow type with the lowest current rating suitable for the application, max. 12.5 A) in a non-earthed input conductor directly at the input of the switching regulator. If Vo+ is earthed, insert the fuse in the Gi- line. For UL's purpose, the fuse needs to be UL-listed. If option C is fitted, a suitable fuse is already built-in in the Vi+ line.

⁴ The earth connection has to be provided by the installer according to the relevant safety standard, e.g. IEC/EN 60950.

⁵ Has to be insulated from earth by double or reinforced insulation according to the relevant safety standard, based on the maximum output voltage from the front end.

Description of Options

-9 Extended Temperature Range

The operational ambient temperature range is extended to $T_A = -40...71^\circ\text{C}$. ($T_C = -40...95^\circ\text{C}$, $T_S = -55...100^\circ\text{C}$.)

Y PCB Soldering Pins

This option defines soldering pins of $1.0 \times 0.5 \times 6.5$ mm, instead of the standard fast-on terminals of $2.8 \times 0.5 \times 6.5$ mm. Regulators with this option can be mounted onto printed circuit boards, providing through-plated finished hole size of $\varnothing 1.3...1.5$ mm.

Accessories

A variety of electrical and mechanical accessories are available including:

- Isolation pads for easy and safe PCB-mounting.
- Filters and ring core chokes for ripple and interference reduction.
- Adaptor kits for DIN-rail and chassis mounting.

For detailed information see: *Accessories on the Power-One homepage.*

P Potentiometer

Option P excludes R function. The output voltage U_o can be adjusted with a screwdriver in the range from 0.92...1.08 of the nominal output voltage $U_{o\text{ nom}}$.

However, the minimum differential voltage $\Delta U_{i,o\text{ min}}$ between input and output voltages as specified in: *Electrical Input Data* should be maintained.

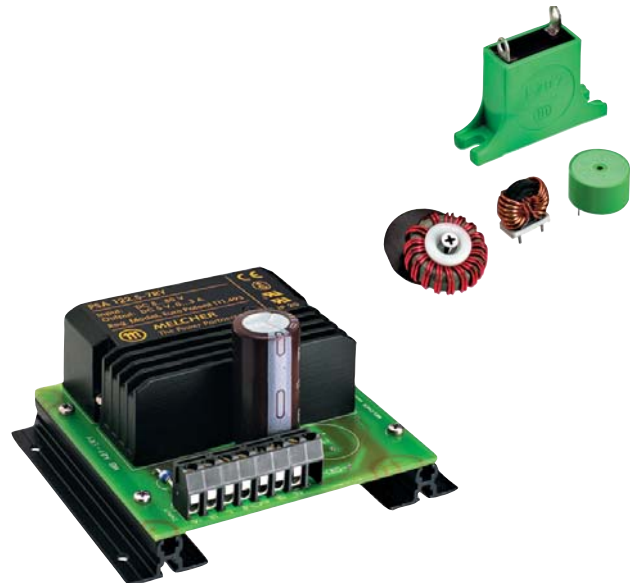

NUCLEAR AND MEDICAL APPLICATIONS - Power-One products are not authorized for use as critical components in life support systems, equipment used in hazardous environments, or nuclear control systems without the express written consent of the respective divisional president of Power-One, Inc.

TECHNICAL REVISIONS - The appearance of products, including safety agency certifications pictured on labels, may change depending on the date manufactured. Specifications are subject to change without notice.

EC Declaration of Conformity

We

Power-One AG
Ackerstrasse 56 CH-8610 Uster

declare under our sole responsibility that all PSx Series switching regulators carrying the CE-mark are in conformity with the provisions of the Low Voltage Directive (LVD) 73/23/EEC of the European Communities.

Conformity with the directive is presumed by conformity with the following harmonized standards:

- EN 61204: 1995 (= IEC 61204: 1993, modified)
Low-voltage power supply devices, d.c. output - Performance characteristics and safety requirements
 - EN 60950: 1992 + A1: 1993 + A2 (= IEC 950 second edition 1991 + A1: 1992 + A2: 1993)
Safety of information technology equipment
-

The installation instructions given in the corresponding data sheet describe correct installation leading to the presumption of conformity of the end product with the LVD. All PSx Series Switching Regulators are components, intended exclusively for inclusion within other equipment by an industrial assembly operation or by professional installers. They must not be operated as stand alone products.

Hence conformity with the Electromagnetic Compatibility Directive 89/336/EEC (EMC Directive) needs not to be declared. Nevertheless, guidance is provided in most product application notes on how conformity of the end product with the indicated EMC standards under the responsibility of the installer can be achieved, from which conformity with the EMC directive can be presumed.

Uster, 1 Sep. 2003

Power-One AG



Rolf Baldauf
Director Engineering



Johann Milavec
Director Products and IP