

APPROVAL

PART NO.	DESCRIPTION	REMARKS
HT2403L	LCD MODULE (240 x RGB x 320 Dots)	* ROHS compliant

CUSTOMER APPLICATION P/N	
APPROVED BY	
DATE	

PLEASE KINDLY FIND AND APPROVE THE SPECIFICATIONS INSERTED
HEREIN AND RETURN ONE COPY HERE OF WITH YOUR SIGNATURE OF APPROVAL.

PERPARED BY	CHECKED BY	CONFIRMED BY



HYES Optoelectronics, Inc.

2000 Wyatt Drive Suite 6
Santa Clara, CA 95054 USA

C O N T E N T S

- 1. Basic Specifications**
 - 1.1 Display Specifications**
 - 1.2 Mechanical Specifications**
 - 1.3 Outline Dimension**
 - 1.4 Voltage Generation Circuit**
 - 1.5 Schematic**
- 2. Electrical Characteristics**
 - 2.1 Absolute Maximum Ratings**
 - 2.2 Environmental Conditions**
 - 2.3 DC Characteristics**
- 3. Optical Characteristics**
- 4. Interface Pins**
- 5. Backlight Specifications (LED Unit)**
- 6. Recommended Software Setting Values (Initial code)**
- 7. Power Supply Sequence**
- 8. Read/Write Timing characteristics (80 series MPU)**
- 9. LCD Module Out-Going Quality Level**
- 10. The Caution and Handling**

Date : Aug. 26, 2008

TECHNICAL SPECIFICATION

HYES

LCM

HT2403L

Page 3 of 24

1. Basic Specifications

1.1 Display Specifications

Item	Description	Note
Resolution	240 × RGB × 320	
Display mode	TFT, Normally White, Transmissive	
Viewing direction	6 O'clock	
Driving method	720Ch-Source, 320Ch-Gate	
Backlighting	LED, White (4 chips in Serial)	
Diver IC	S6D1121, COG	
Others	80-Series, 18/16/9/8-Bit Parallel	

1.2 Mechanical Specifications

Item	Specification	Unit
Module Size (W × H × T)	42.62 × 60.5 × 2.45	mm
Viewing Area (W × H)	-	mm
Active Area (W × H)	36.72 × 48.96	mm
Dot Size (W × H)	-	mm
Dot Pitch (W × H)	0.051 × 0.153	mm
Weight	About 10	g

Date : Aug. 26, 2008

TECHNICAL SPECIFICATION

HYES

LCM

HT2403L

Page 4 of 24

1.3 Outline Dimension

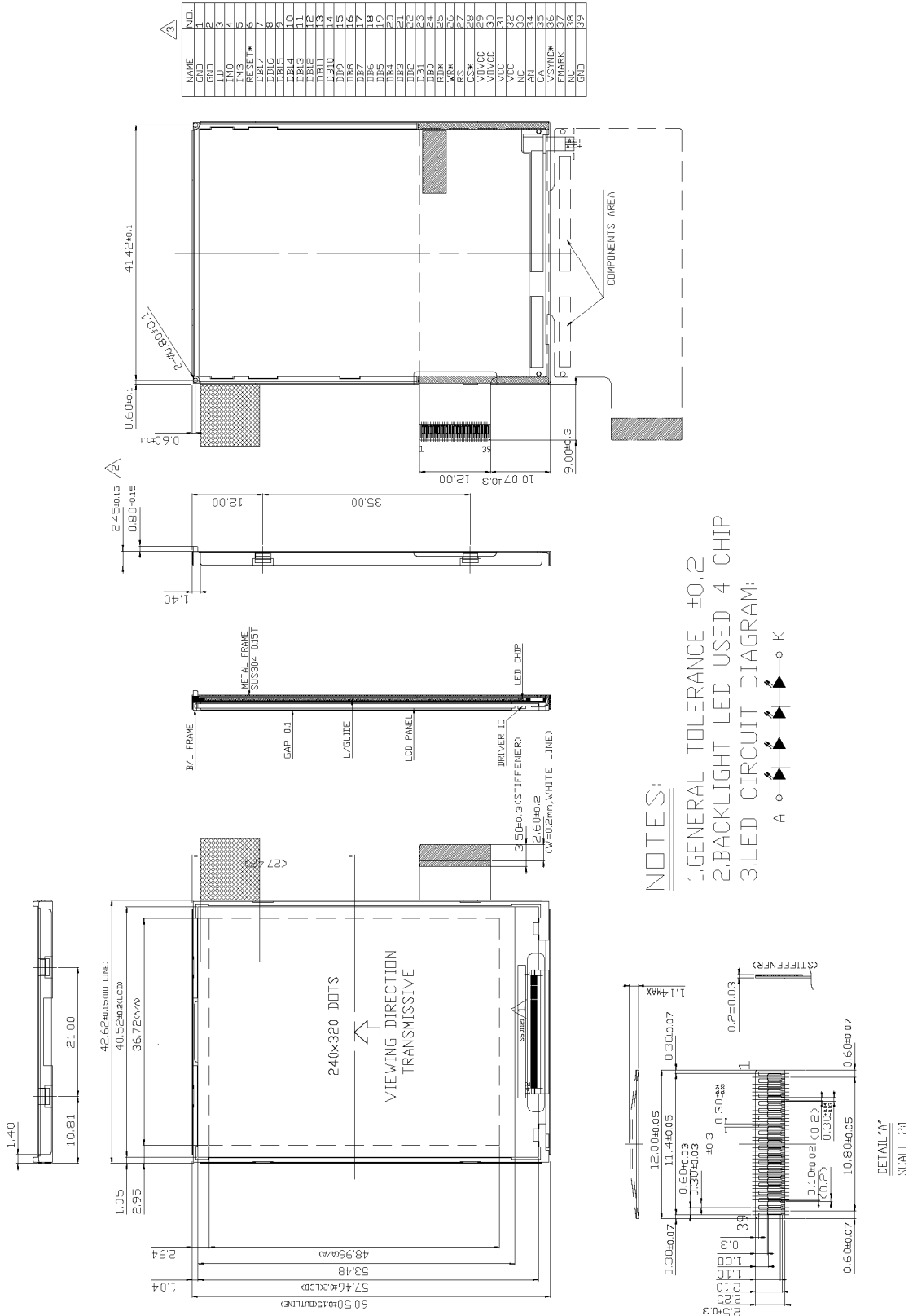

1.4 Block Diagram

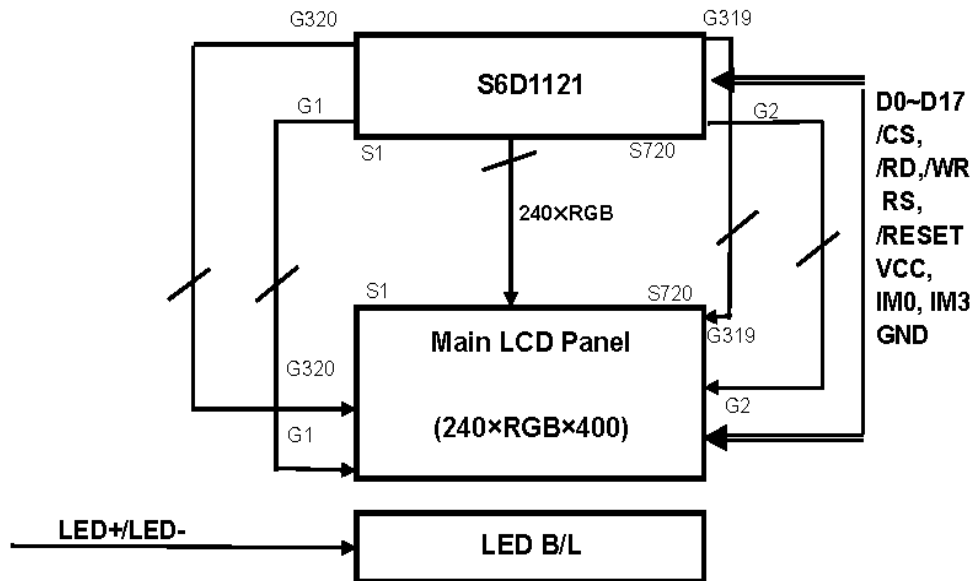

CF1	CF0	Interface	Datebus
1	0	18-bit interface	DB17-DB0
1	1	9-bit interface	DB17-DB9
0	0	16-bit interface	DB17-DB10, DB8-DB1
0	1	8-bit interface	DB17-DB10

Date : Aug. 26, 2008

TECHNICAL SPECIFICATION

HYES

LCM

HT2403L

Page 6 of 24

1.5 Schematic

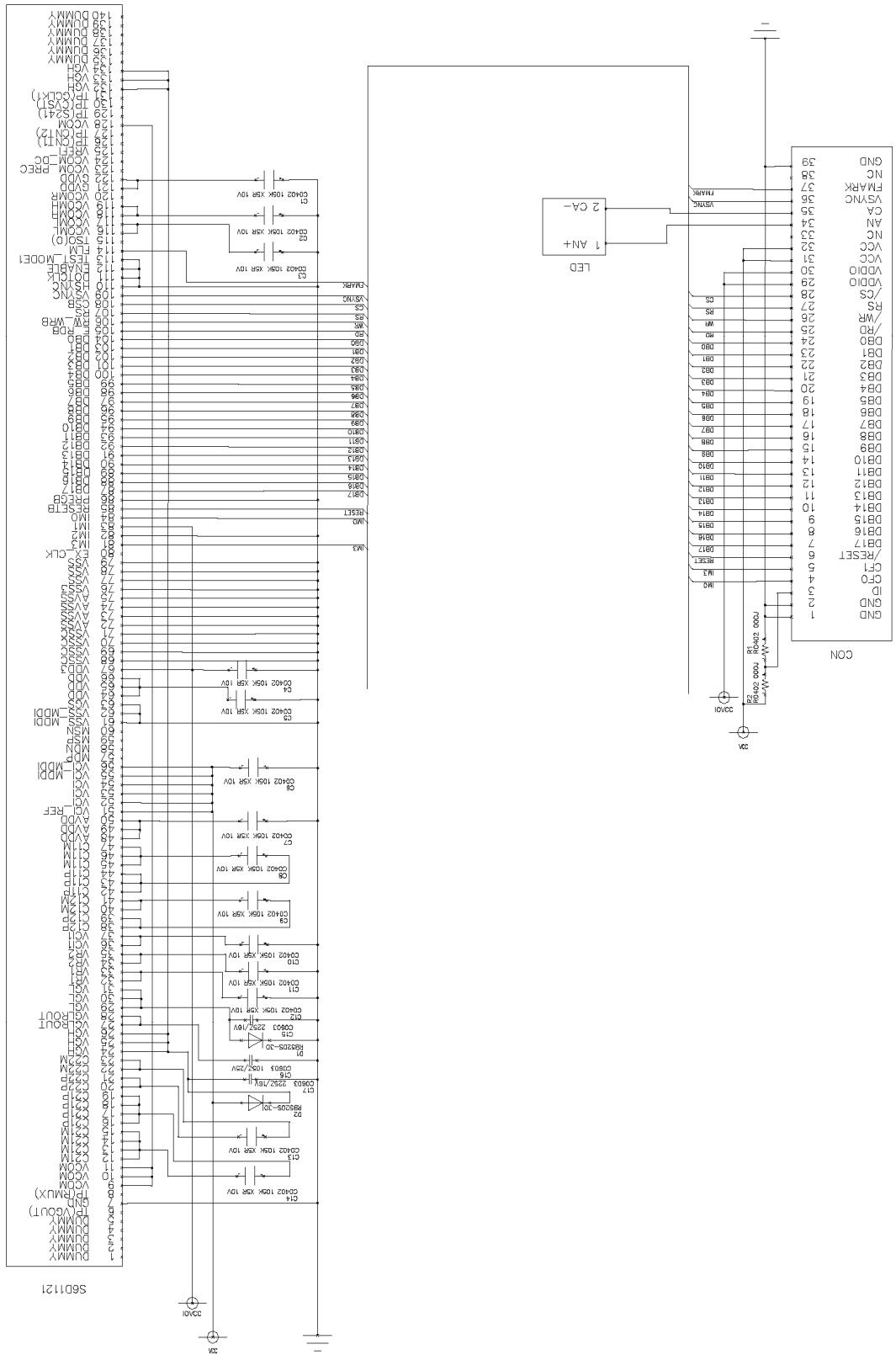

Date : Aug. 26, 2008

TECHNICAL SPECIFICATION



LCM

HT2403L

Page 7 of 24

2. Electrical Characteristics

2.1 Absolute Maximum Ratings

Item	Symbol	Value			Unit	Condition	Remark
		Min.	Typ.	Max			
Supply Voltage Range	Logic	VDDIO	-0.3	-	5.0	V	Ta =25℃
	Power Supply	VCC	-0.3	-	5.0	V	Ta =25℃
	LCD	VGH-VGL	-0.3	-	35.0	V	Ta =26℃
Input Voltage	V _{IN}	-0.3	-	VCC+0.5	V	Ta =25℃	

2-2 Environmental Conditions

Item	Symbol	Min.	Max.	Unit
Operating temperature	Topr	-20	70	℃
Storage temperature	Tstg	-30	80	℃
Humidity (Ambient temperature=Ta)	Ta ≤ 60℃		90% RH max.	

2-3 DC Characteristics

Items	Sysbol	Spec. Value			Unit	Condition	
		Min.	Typ.	Max.			
Operating Voltage	Logic	VDDIO	1.65	1.8	3.3	V	
	Power Supply	VCC	1.65	2.8	2.88	V	
	GATE	VGH	7.5	-	18	V	Note1)
		VGL	-11	-	-5.5	V	
Supply current	ICC	-	9.5	14.3	mA	Note2)	
Input voltage	High level	V _{IH}	0.8 × V _{CC}	-	V _{CC}	V	-
	Low level	V _{IL}	0	-	0.2 × V _{CC}	V	-

Note1) The value can be adjusted by software to optimize display quality.

Note2) Display black

Date : Aug. 26, 2008

TECHNICAL SPECIFICATION

HYES

LCM

HT2403L

Page 8 of 24

3. Optical Characteristics

Transmissive mode

(Ta = 25°C)

Item	Symbol		Min.	Typ.	Max.	Unit	Condition	Note
Viewing	θ2-θ1	∅=0 (Y1-Y2)	50	60	-	Deg	Cr > 10	
		∅=90 (X1-X2)	80	90	-			
Contrast ratio	Cr		200	380	-	-	θ = 0 ∅ = 0	
Response Time	Tr + Tf		-	25	40	ms	θ = 0 ∅ = 0	
CIE Coordi- -nate	R	(x,y)	0.58, 0.30	0.62, 0.34	0.68, 0.38		θ = 0 ∅ = 0	
	G	(x,y)	0.28, 0.55	0.32, 0.59	0.38, 0.63			
	B	(x,y)	0.01, 0.04	0.14, 0.08	0.18, 0.12			
	W	(x,y)	0.24, 0.26	0.28, 0.30	0.32, 0.34			
Brightness	L		230	290	-	cd/m ²	18mA/LED	
Uniformity			70	-	-			

* ∅ = 0°, ∅ = 90° means viewing direction.

* B/L is turned on.

* Remark : as for contrast ratio, it is measured in panel only.

Date : Aug. 26, 2008

TECHNICAL SPECIFICATION

HYES

LCM

HT2403L

Page 9 of 24

Note 1 . Definition of angle Θ and Φ

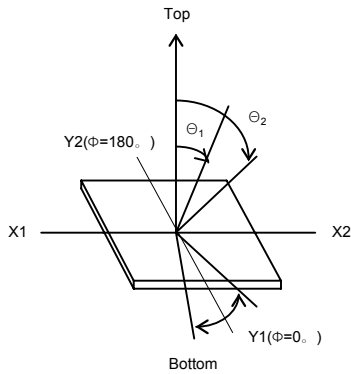

Note 2. Definition of viewing angle Θ_1 and Θ_2

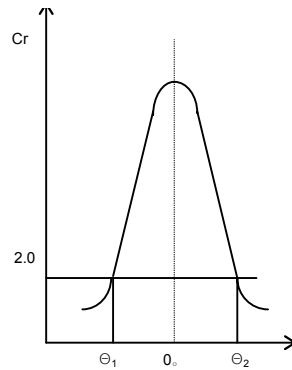

Note 3. Definition of contrast Cr

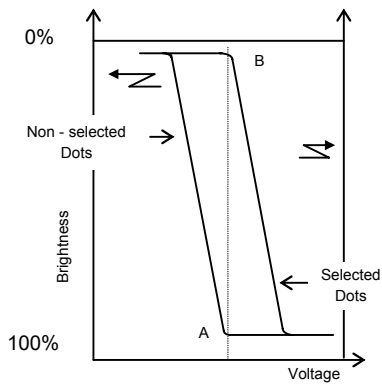

$Cr = (A/B)^P$ Negative : P = -1 Set Point
 Positive : P = +1

Lens $\varnothing = 3\text{mm}$

Note 4. Definition of Optical response

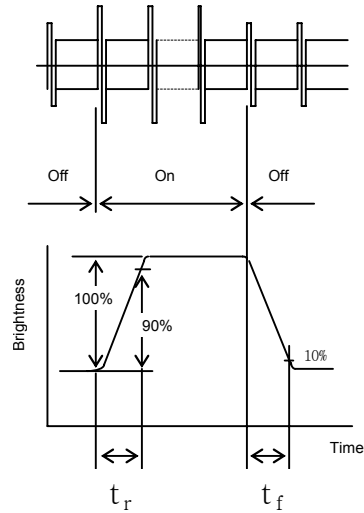

Note 5. Measuring Point(9 POINTS) (WxH)

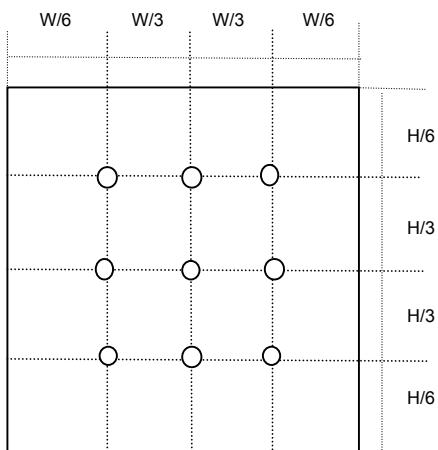

Rating is defined as the average brightness inside the viewing area

Date : Aug. 26, 2008

TECHNICAL SPECIFICATION

HYES

LCM

HT2403L

Page 10 of 24

4. Interface Pins

No.	symbol	Description
1	GND	Ground
2	GND	Ground
3	ID	ID bit setting of device ID code
4	CF0	CPU Interface Mode Selection(IM0)
5	CF1	CPU Interface Mode Selection(IM3)
6	RESET	RESET signal(low active)
7	DB17	Data Bus (Instruction & Display Data)
8	DB16	Data Bus (Instruction & Display Data)
9	DB15	Data Bus (Instruction & Display Data)
10	DB14	Data Bus (Instruction & Display Data)
11	DB13	Data Bus (Instruction & Display Data)
12	DB12	Data Bus (Instruction & Display Data)
13	DB11	Data Bus (Instruction & Display Data)
14	DB10	Data Bus (Instruction & Display Data)
15	DB9	Data Bus (Instruction & Display Data)
16	DB8	Data Bus (Instruction & Display Data)
17	DB7	Data Bus (Instruction & Display Data)
18	DB6	Data Bus (Instruction & Display Data)
19	DB5	Data Bus (Instruction & Display Data)
20	DB4	Data Bus (Instruction & Display Data)
21	DB3	Data Bus (Instruction & Display Data)
22	DB2	Data Bus (Instruction & Display Data)
23	DB1	Data Bus (Instruction & Display Data)
24	DB0	Data Bus (Instruction & Display Data)
25	RD	Read Signal
26	WR	Write Signal
27	RS	Data/command identification
28	CS	Chip Select
29	VDDIO	Power Supply for Interface (1.8V)
30	VDDIO	Power Supply for Interface (1.8V)
31	VCC	Power Supply for Analog and Logic (2.8V)
32	VCC	Power Supply for Analog and Logic (2.8V)
33	NC	No connection
34	AN	Power Supply for LED
35	CA	GND for LED
36	VSYNC	Frame synchronous signal
37	FMARK	Frame head pulse signal
38	NC	No connection
39	GND	Ground

Date : Aug. 26, 2008

TECHNICAL SPECIFICATION

HYES

LCM

HT2403L

Page 11 of 24

5. Backlight Specification (LED Unit)

Item	Symbol	Spec. Value			Unit	Condition
		Min.	Typ.	Max.		
Real Current	I_{LED}	-	18	20	mA	note 1.
Power dissipation	P_D	-	-	160	mW	note 2.
Operation temp.	T_{opr}	- 20 ~ 70			°C	-
Storage temp.	T_{str}	- 30 ~ 80			°C	-

Note 1. B/L: 4EA LED in Serial, the typical current is 18mA (full brightness).

Note2. Total power consumption (max) depends on LED current/ LED driver efficiency, etc.

6. Recommended Software Setting Values (Initial code)

LDI :S6D1121

	REG NO	VALUE
P O W E R	0011	1D04
	0012	0033
	0013	CC00
	0015	382E
	0014	002A
	0013	CC04(DELAY 10ms)
	0013	CC06(DELAY 50ms)
	0013	CC4F(DELAY 10ms)
	0013	674F
G A M M A R	0011	1D02
	0030	0100
	0031	220E
	0032	211F
	0033	2423
	0034	2628
	0035	3127
	0036	211E
	0037	1723
	0038	0F15
	0039	0A0A
	003A	1315
	003B	3619
	003C	0102
S E T T I N G	003D	0000
	0016	0006
	0001	0127
	0002	0013
	0003	0003
	0008	0208
	000A	0507
	000B	0000
	000C	0003
	0041	0000
	0050	0000
	0060	0005
	0070	000B
	0071	0000
O T H E R	0078	0000
	0079	0000
	007A	0000(DELAY 50ms)
M O D E		

	REG NO	VALUE
D I S P	0007	0051(DELAY 50)ms
	0007	0053(DELAY 20)ms
	0020	0000
	0021	0000
	0022	

Standby on sequence

Display off sequence	
0007	0052(DELAY 40ms)
0007	0050
0007	0010
Power off sequence	
0012	0000
0013	CC46(DELAY 50ms)
0013	CC44(DELAY 50ms)
0013	CC40
set standby mode	
0010	0001

Standby off sequence

0004	2501(DELAY 20ms)
0010	0000(DELAY 20ms)
Call power on sequence	
Call display on sequence	

Partial display sequence

0007	0053
0042	the end of 1st screen
0043	the start of 1st screen
0044	the end of 2nd screen
0045	the start of 2nd screen
DELAY 50ms	
0007	4153
Return to full display	
0042	013F
0043	0000
0044	013F
0045	0000
END	

NOTE: HYES requires the customer to follow the above instructions strictly. If customer would like to change the above instructions, the customer should inform HYES and get re-check from HYES, or the customer will be responsible for any unexpected result because of the change.

Date : Aug. 26, 2008

TECHNICAL SPECIFICATION

HYES

LCM

HT2403L

Page 13 of 24

7. Power Supply Sequence

7.1 Power Supply On/Off Sequence

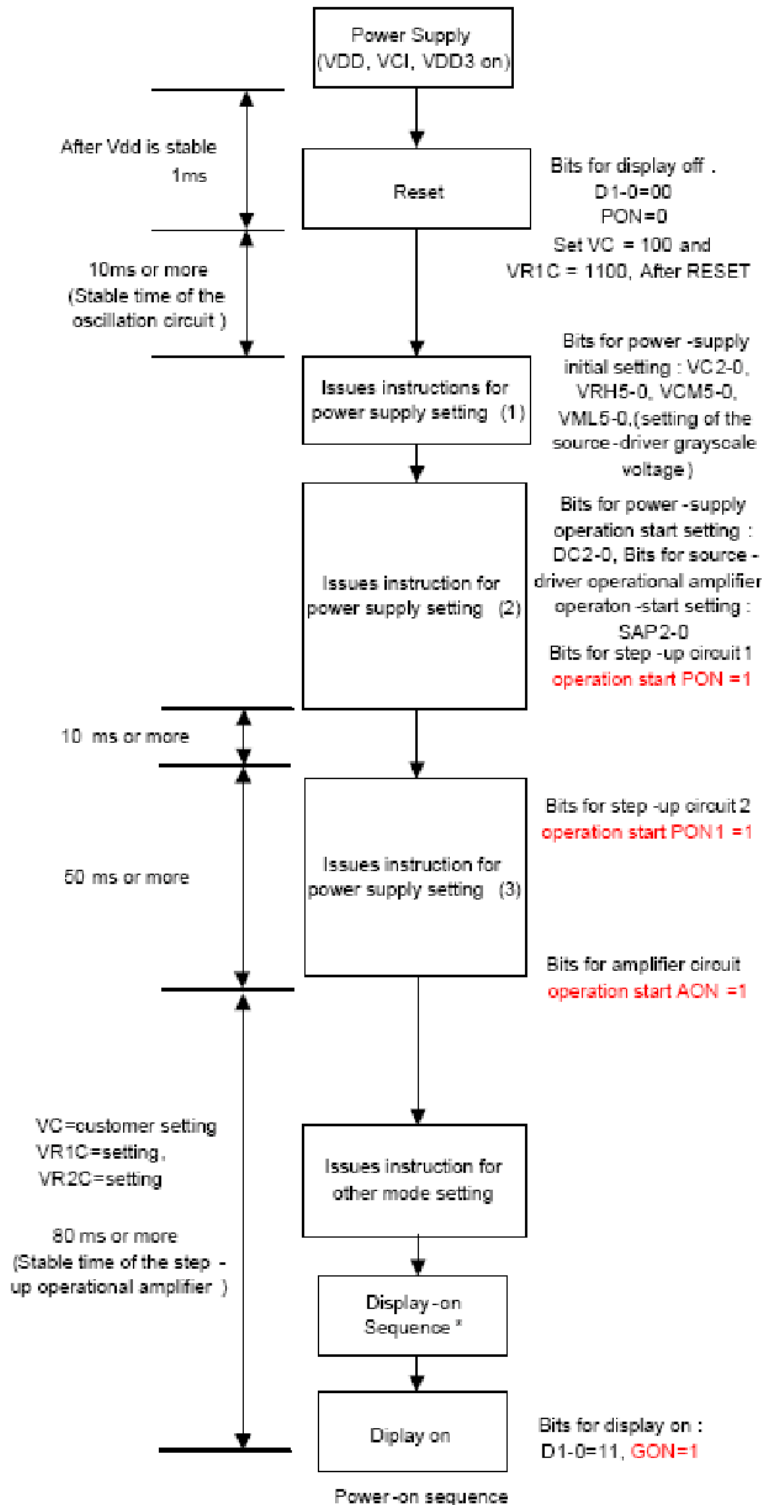

Date : Aug. 26, 2008

TECHNICAL SPECIFICATION

HYES

LCM

HT2403L

Page 14 of 24

7.2 Off Sequence

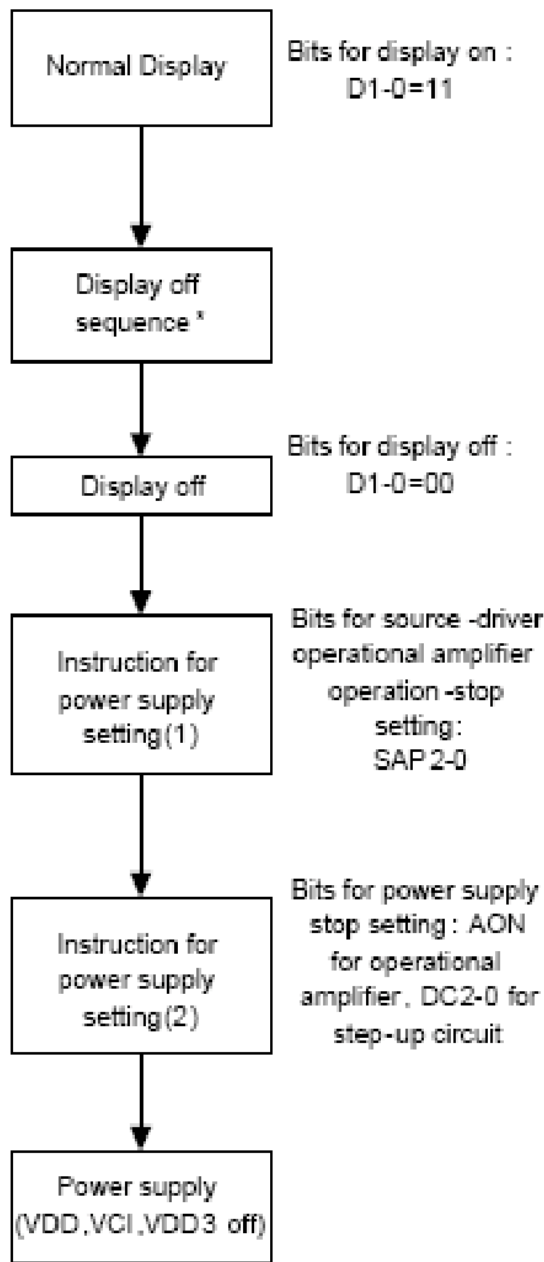

Power-off sequence

Date : Aug. 26, 2008

TECHNICAL SPECIFICATION

HYES

LCM

HT2403L

Page 15 of 24

8. Read/Write Timing characteristics (80 series MPU)

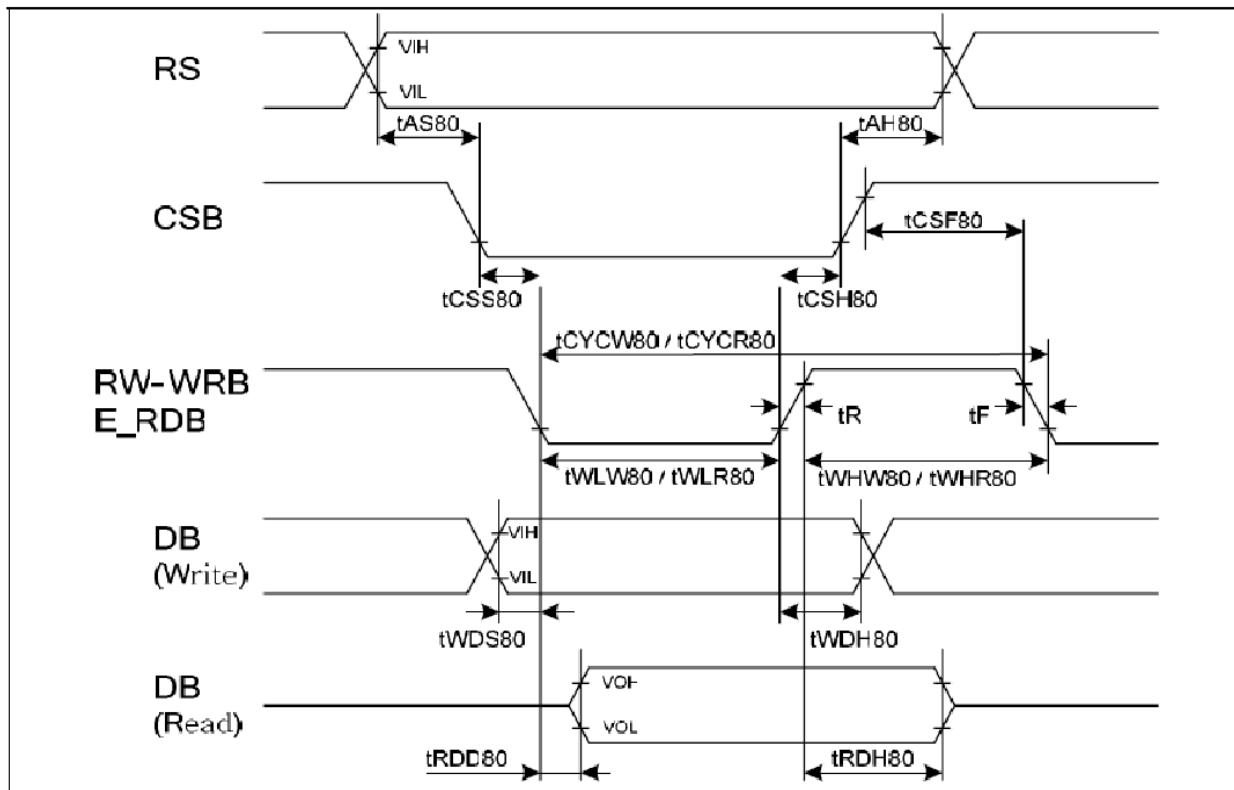

Figure 8.3.2.1 AC Timing Parameter and Timing Diagram of 80-system interface

Table 8.3.2.1 AC Timing Characteristics

(VDD = 1.5 V, VDD3 = 1.65 to 3.3V, T_A = -40 to +85 °C)

Parameter	Symbol	Condition	Min.	Max.	Unit
Address setup time	tAS80	RS ~ CSB	5	-	ns
Address hold time	tAH80		5	-	ns
Chip select setup time	tCSS80	CSB ~ RW_WRB CSB ~ E_RDB	5	-	ns
Chip select hold time	tCSH80		5	-	ns
Chip select wait time	tCSF80		10	-	ns
Write enable period	tCYCW80	RW_WRB	65	-	ns
Write enable low pulse width	tWLW80		22.5	-	ns
Write enable high pulse width	tWHW80		22.5	-	ns
Read enable period	tCYCR80	E_RDB	400	-	ns
Read enable low pulse width	tWLR80		190	-	ns
Read enable high pulse width	tWHR80		190	-	ns
Write data setup time	tWDS80	DB ~ RW_WRB	5	-	ns
Write data hold time	tWDH80		5	-	ns
Read data delay time	tRDD80	DB ~ E_RDB	10	-	ns
Read data hold time	tRDH80		10	-	ns
Rising time	tR	All signals	-	160	ns
Falling time	tF		5	40	ns

Date : Aug. 26, 2008

TECHNICAL SPECIFICATION

HYES

LCM

HT2403L

Page 16 of 24

Reset Timing characteristics

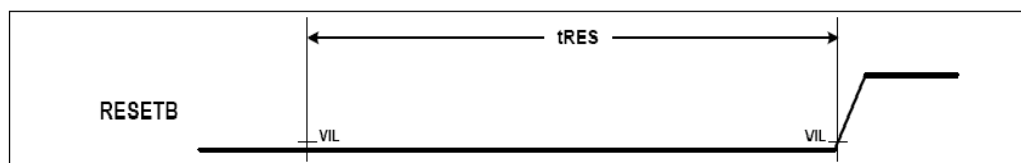

Figure 8.6.1 AC Timing Parameter and Timing Diagram of RESET

Table 8.6.1 AC Characteristics of RESET

(VDD = 1.5 V, VDD3 = 1.65 to 3.3V, T_A = -40 to +85 °C)

Characteristic	Symbol	Min.	Max.	Unit
Reset low pulse width	tRES	15	-	us

9. LCD Module Out-Going Quality Level

(1.0) Purpose

The LCD specification provides outgoing provision and its expected quality level based on our outgoing inspection of LCD.

(2.0) Applicable Scope

The LCD specification is applicable to the arrangement in regard to outgoing inspection and quality assurance after it.

(3.0) Quality Specification

(3.1) Quality Level

The quality level of HYES are based on GB/T2828.1, Apply Level II, normal inspection by single sampling.

Rank	Item	AQL	Note
Major(MA)	Segment Short, Missing	0.65	
	Solder Bridging, Cold Solder		
	Outside Dimension		
Minor (MI)	Black Spots, White Spots, Foreign Substance, Pinhole, Segment Deformation, Scratches(Glass & Pol.) Air Bubbles between Glass & Polarizer, Color Variation, Solder Ball, Misalignment	1.0	

Note) AQL- Acceptable Quality Level

(3.2) Appearance Standards

1) Inspection Conditions

The LCD shall be inspected under 20W white fluorescent lamp light.

The distance between the eyes and the sample shall be 30cm.

All directions for inspecting the sample should be within 30° to perpendicular line.

2) Definition of the Area

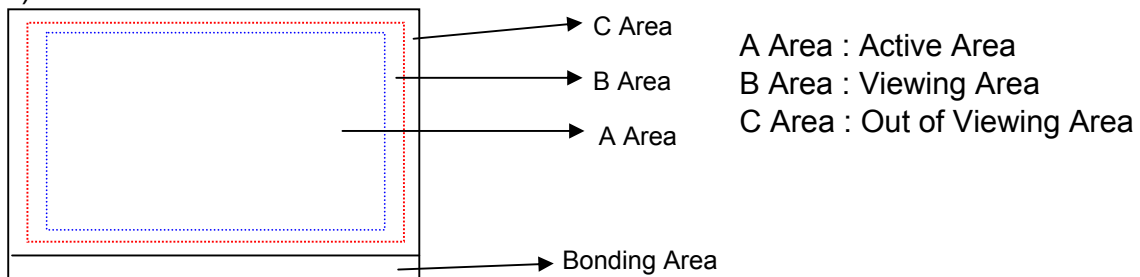

Date : Aug. 26, 2008

TECHNICAL SPECIFICATION

HYES

LCM

HT2403L

Page 18 of 24

(3.3) Appearance Spec

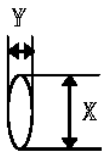
No	Item	Criteria	Rank	Remark																																													
1	Segment Short Segment Missing	Not allowed	MA																																														
2	Solder Bridging	Any bridging between components, except common circuit, is not allowed.	MA																																														
3	Outside Dimension	Drawing & specification must be within permissible tolerance.	MA																																														
4	Cold Solder	Cold solder is not allowed.	MA																																														
5	Black(White) Spots, Foreign Substances	<p>1) Round Type</p> <table border="1"> <thead> <tr> <th rowspan="2">Area Dimension***</th> <th colspan="2">Acceptable Q'ty</th> <th rowspan="2">Remark</th> </tr> <tr> <th>A Area</th> <th>B Area</th> </tr> </thead> <tbody> <tr> <td>≤ 0.1</td> <td colspan="2">Ignore</td> <td rowspan="4"></td> </tr> <tr> <td>≤ 0.2</td> <td>2</td> <td>Ignore</td> </tr> <tr> <td>≤ 0.3</td> <td>1</td> <td>Ignore</td> </tr> <tr> <td>0.3 <</td> <td>0</td> <td>Ignore</td> </tr> </tbody> </table> <p>2) Liner Type</p> <table border="1"> <thead> <tr> <th colspan="2">Dimension</th> <th colspan="2">Acceptable Q'ty</th> <th rowspan="2">Remark</th> </tr> <tr> <th>Length</th> <th>Width</th> <th>A Area</th> <th>B Area</th> </tr> </thead> <tbody> <tr> <td>-</td> <td>≤ 0.025</td> <td colspan="2">Ignore</td> <td rowspan="4"></td> </tr> <tr> <td>≤ 2.5</td> <td>≤ 0.05</td> <td>3</td> <td>Ignore</td> </tr> <tr> <td>≤ 1.5</td> <td>≤ 0.075</td> <td>2</td> <td>Ignore</td> </tr> <tr> <td></td> <td>0.075 <</td> <td colspan="2">Follow round type</td> </tr> </tbody> </table> <p>At (1) & (2) total defect q'ty is must not exceed 5 pieces.</p>	Area Dimension***	Acceptable Q'ty		Remark	A Area	B Area	≤ 0.1	Ignore			≤ 0.2	2	Ignore	≤ 0.3	1	Ignore	0.3 <	0	Ignore	Dimension		Acceptable Q'ty		Remark	Length	Width	A Area	B Area	-	≤ 0.025	Ignore			≤ 2.5	≤ 0.05	3	Ignore	≤ 1.5	≤ 0.075	2	Ignore		0.075 <	Follow round type		MI	 <p>*** : Mean Diameter (X + Y)/2</p>
Area Dimension***	Acceptable Q'ty			Remark																																													
	A Area	B Area																																															
≤ 0.1	Ignore																																																
≤ 0.2	2	Ignore																																															
≤ 0.3	1	Ignore																																															
0.3 <	0	Ignore																																															
Dimension		Acceptable Q'ty		Remark																																													
Length	Width	A Area	B Area																																														
-	≤ 0.025	Ignore																																															
≤ 2.5	≤ 0.05	3	Ignore																																														
≤ 1.5	≤ 0.075	2	Ignore																																														
	0.075 <	Follow round type																																															
6	OC Spot	<table border="1"> <thead> <tr> <th rowspan="2">Area Dimension***</th> <th colspan="2">Acceptable Q'ty</th> <th rowspan="2">Remark</th> </tr> <tr> <th>A Area</th> <th>B Area</th> </tr> </thead> <tbody> <tr> <td>≤ 0.2</td> <td colspan="2">Ignore</td> <td rowspan="3"></td> </tr> <tr> <td>≤ 0.8</td> <td>3</td> <td>Ignore</td> </tr> <tr> <td>≤ 1.0</td> <td>1</td> <td>Ignore</td> </tr> </tbody> </table>	Area Dimension***	Acceptable Q'ty		Remark	A Area	B Area	≤ 0.2	Ignore			≤ 0.8	3	Ignore	≤ 1.0	1	Ignore	MI																														
Area Dimension***	Acceptable Q'ty			Remark																																													
	A Area	B Area																																															
≤ 0.2	Ignore																																																
≤ 0.8	3	Ignore																																															
≤ 1.0	1	Ignore																																															
7	Air Bubbles Between Glass & Polarizer (Polarizer Defects)	<table border="1"> <thead> <tr> <th rowspan="2">Area Dimension***</th> <th colspan="2">Acceptable Q'ty</th> <th rowspan="2">Remark</th> </tr> <tr> <th>A Area</th> <th>B Area</th> </tr> </thead> <tbody> <tr> <td>≤ 0.15</td> <td colspan="2">Ignore</td> <td rowspan="5"></td> </tr> <tr> <td>≤ 0.3</td> <td>3</td> <td>Ignore</td> </tr> <tr> <td>≤ 0.5</td> <td>2</td> <td>Ignore</td> </tr> <tr> <td>≤ 0.7</td> <td>1</td> <td>Ignore</td> </tr> <tr> <td>Total</td> <td>5</td> <td>Ignore</td> </tr> </tbody> </table>	Area Dimension***	Acceptable Q'ty		Remark	A Area	B Area	≤ 0.15	Ignore			≤ 0.3	3	Ignore	≤ 0.5	2	Ignore	≤ 0.7	1	Ignore	Total	5	Ignore	MI																								
Area Dimension***	Acceptable Q'ty			Remark																																													
	A Area	B Area																																															
≤ 0.15	Ignore																																																
≤ 0.3	3	Ignore																																															
≤ 0.5	2	Ignore																																															
≤ 0.7	1	Ignore																																															
Total	5	Ignore																																															

Date : Aug. 26, 2008

TECHNICAL SPECIFICATION

HYES

LCM

HT2403L

Page 19 of 24

(3.3) Appearance Spec

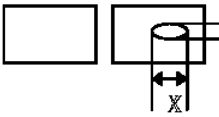
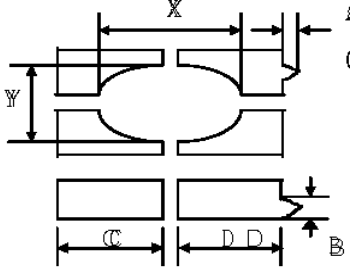
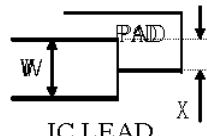
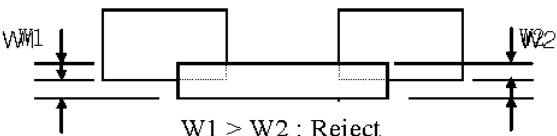
No	Item	Criteria	Rank	Remark								
8	Pin hole (On Segment)	 <p> $(X+Y)/2 \leq 0.2\text{mm}$ Within 1 per one segment (Less than 0.1mm is not counted) Total defects q'ty is must not exceed 5 pieces. </p>	MI									
9	Segment Deformation	 <p> $(X+Y)/2 \leq 0.2\text{mm}$ $A \leq 0.2\text{mm}$ $B \leq 0.2\text{mm}$ $(C-D) \leq 0.2\text{mm}$ </p> <table border="1" data-bbox="518 846 1161 987"> <thead> <tr> <th></th> <th>Acceptable Q'ty</th> </tr> </thead> <tbody> <tr> <td>Dot, Segment</td> <td>1</td> </tr> <tr> <td>LCD</td> <td>5</td> </tr> <tr> <td>≤ 0.1</td> <td>Ignore all defect</td> </tr> </tbody> </table> <p>Each visible dot must be more than half effective dot area</p>		Acceptable Q'ty	Dot, Segment	1	LCD	5	≤ 0.1	Ignore all defect	MI	$(X + Y)/2 \leq 0.2\text{mm}$
	Acceptable Q'ty											
Dot, Segment	1											
LCD	5											
≤ 0.1	Ignore all defect											
10	Color Variation	Within the three colors, except LCD Standard color is acceptable.	MI									
11	Glass & Polarizer Scratch	Follow NO.5(2) condition	MI									
12	Solder Ball	1)Acceptable if the size of void is less than 0.18mm 2)Acceptable if a solder ball is not movable 3)Rejectable if the solder ball exceed SEA in $2.54 \times 2.54\text{mm}$ area.	MI									
13	Miss Alignment	1)Acceptable if it dose not exceed 50% of the lead width IC.  <p> $X \leq W/2$: Accept $X > W/2$: Reject </p> 2)Rejectable, provided that it does exceed 50% of the component termination width.  <p> $W1 > W2$: Reject </p>										

Note : A limitation sample is given top priority

Date : Aug. 26, 2008

TECHNICAL SPECIFICATION



HYES

LCM

HT2403L

Page 20 of 24

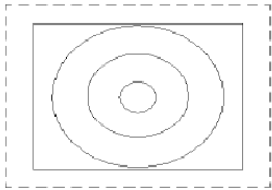
(3.3) Appearance Spec

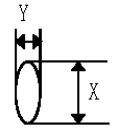
No	Item	Criteria	Rank	Remark																																																
14	Touch Panel	<p>1) Round Type、 Foreign Substances</p> <table border="1"> <thead> <tr> <th rowspan="2">Area Dimension**</th> <th colspan="2">Acceptable Q'ty</th> <th rowspan="2">Remark</th> </tr> <tr> <th>A Area</th> <th>B Area</th> </tr> </thead> <tbody> <tr> <td>≤ 0.1</td> <td colspan="2">Ignore</td> <td rowspan="4"></td> </tr> <tr> <td>≤ 0.2</td> <td>2</td> <td>Ignore</td> </tr> <tr> <td>≤ 0.3</td> <td>1</td> <td>Ignore</td> </tr> <tr> <td>0.3 <</td> <td>0</td> <td>Ignore</td> </tr> </tbody> </table> <p>2) Liner Type & Scratch</p> <table border="1"> <thead> <tr> <th colspan="2">Dimension</th> <th colspan="2">Acceptable Q'ty</th> <th rowspan="2">Remark</th> </tr> <tr> <th>Length</th> <th>Width</th> <th>A Area</th> <th>B Area</th> </tr> </thead> <tbody> <tr> <td>-</td> <td>W ≤ 0.025</td> <td colspan="2">Ignore</td> <td rowspan="6">Ignore</td> </tr> <tr> <td>L ≤ 3.0</td> <td rowspan="2">W ≤ 0.05</td> <td colspan="2">Ignore</td> </tr> <tr> <td>3.0 < L ≤ 5.0</td> <td colspan="2">2</td> </tr> <tr> <td>≤ 7</td> <td>W ≤ 0.1</td> <td colspan="2">1</td> </tr> <tr> <td>-</td> <td>W > 0.1</td> <td colspan="2">Follow round type</td> </tr> </tbody> </table> <p>4) Newton Ring</p> <p>a) Regular</p>  <p>The area of the Newton ring is more than 1/3 area of the touch panel It's NG. The area of the Newton ring is less than 1/3 area of the touch panel It's OK.</p> <p>b) None-regularity</p>  <p>The area of the Newton ring is more than 1/2 area of the touch panel It's NG. The area of the Newton ring is less than 1/2 area of the touch panel It's OK.</p>	Area Dimension**	Acceptable Q'ty		Remark	A Area	B Area	≤ 0.1	Ignore			≤ 0.2	2	Ignore	≤ 0.3	1	Ignore	0.3 <	0	Ignore	Dimension		Acceptable Q'ty		Remark	Length	Width	A Area	B Area	-	W ≤ 0.025	Ignore		Ignore	L ≤ 3.0	W ≤ 0.05	Ignore		3.0 < L ≤ 5.0	2		≤ 7	W ≤ 0.1	1		-	W > 0.1	Follow round type		MI	 <p>** : Mean Diameter (X + Y)/2</p>
Area Dimension**	Acceptable Q'ty			Remark																																																
	A Area	B Area																																																		
≤ 0.1	Ignore																																																			
≤ 0.2	2	Ignore																																																		
≤ 0.3	1	Ignore																																																		
0.3 <	0	Ignore																																																		
Dimension		Acceptable Q'ty		Remark																																																
Length	Width	A Area	B Area																																																	
-	W ≤ 0.025	Ignore		Ignore																																																
L ≤ 3.0	W ≤ 0.05	Ignore																																																		
3.0 < L ≤ 5.0		2																																																		
≤ 7	W ≤ 0.1	1																																																		
-	W > 0.1	Follow round type																																																		

Date : Aug. 26, 2008

TECHNICAL SPECIFICATION

HYES

LCM

HT2403L

Page 21 of 24

(4.0) Reliability Condition

Item	Content
Room Temperature Operation	50,000 hrs

(4.1) Reliability Test - Module Middle Reliability

No.	Item	Condition	Test Time	Sample Numbers	Criteria (Acc/Rej)	Note
1	High Temp Operation	70 ± 2°C	120 hrs	3	0/1	
2	Low Temp Operation	-20 ± 2°C	120 hrs	3	0/1	
3	High Humidity Storage	60°C 90%rh	120 hrs	3	0/1	
4	Thermal Shock	30mn stage -20°C ↔70°C	100 cycles /6days	3	0/1	

(4.2) Criteria

- a. No changes for indication and appearance.
- b. Leave the all samples under room temperature 4 hours after reliability test ends.

10. LCD Module Operation Instruction

Part I. How to use the LCD Module

1. Don't hit the LCD Panel in any way because the LCD is made of glass.
2. Don't clean the surface of LCD with hard things. Please clean LCD with Air-gun or very soft cloth when necessary. The protective film on the POL can be removed just before assembly, otherwise, dust, spit or other foreign matter may attached on the LCD under the protective film. After the protective film is removed, only air-gun can be used to remove any dust or foreign matter. Fingure or cloth MUST NOT be used in such cases.
3. No chemical liquid is allowed to clean the LCD, such as alcohol, acetone and IPA. All of these candamage the LCD. Water on the LCD must be cleaned as soon as possible, for it will cause POL color change or other defect.
4. Please move and assemble LCD very carefully during assembly, and don't push or twist it.
5. Don't damage the FPC of LCD module. It will cause permanent defect.
6. Don't disassemble LCD module. It will cause permanent defect.
7. Don't expose LCD module under sunshine, strong fluorescence or ultraviolet radiation.
8. Please make sure that operators wear static-protective bands effectively and working tables are effectively earthing during operation.
9. Please place LCD module on the tray provided by HYES while moving it, in order to avoid mechanical damage. Hold the module's side frames to avoide damage during moving.
10. Don't twist, disassemble, squeeze or hit the PCB. It will damage the circuit or component on PCB and cause functional defect.
11. Please use the connector according to the instruction provided by HYES.
12. Please place dual module with the sub-panel upward. Trays should be placed in contrary direction. An empty tray should be placed on the top.
13. Sealing operation on PCB must be very careful to avoid short or cut the original circuit on PCB. Otherwise, it will cause permanant damage to the LCD.
14. Don't add direct DC or high voltage to LCD panel. It will cause functional damage to the LCD or shorten the life of LCD product.
15. LCD may respond slowly or display abnormally in extrem temperature (lower than -20°C or higher than 50°C). But this doesn't mean LCD functional defect. LCD will display normally in regular temperature. Therefore, don't use LCD product in extrem temperature.

Date : Aug. 26, 2008

TECHNICAL SPECIFICATION

HYES

LCM

HT2403L

Page 23 of 24

- 16. Don't push the display area of LCD panel, it will cause abnormal display. This doesn't mean LCD functional defect, neither. LCD will display normally in regular temperature.
- 17. Electrical test of LCD product is made by using mobile phone provided by Customer. We can use special test equipment to do the test, also.
- 18. The black band on IC on LCD product is used to protect the IC from light. Please do NOT remove it.
- 19. Please take great care to use connector. Customer should be responsible for connector defect caused by operation on Customer side.

Part II Storage

- 1. Physical status of liquid crystal will change in extrem temperature, and it can not be resumed when the temperature returns to be normal. So LCD module should be stored in required temperature.
- 2. LCD module should be stored in required humidity. Low humidity may add static, while high humidity may corrode the ITO circuit of LCD product. The suitable storage environment is: temperature: $22 \pm 5^{\circ}\text{C}$, humidity: $55\% \pm 10\%$.
- 3. Don't expose LCD module under sunshine, strong fluorescence or ultraviolet radiation for a long time. It should be stored in dark area.
- 4. LCD should be stored in static-protective polythene bag. Don't expose it in the air for a long time.

Date : Aug. 26, 2008		TECHNICAL SPECIFICATION	
	LCM	HT2403L	Page 24 of 24