

**SPECIFICATIONS**

Electrical Ratings	5A @ 120VAC, 28VDC; 2A @ 250VAC See Contact Options
Electrical Life	30,000 cycles typical
Contact Resistance	< 20 mΩ max initial @ 2-4VDC, 100mA
Dielectric Strength	1500Vrms min
Insulation Resistance	> 100MΩ min
Operating Temperature	-40°C to 85°C
Storage Temperature	-40°C to 85°C



Process Sealed  
c **UL** US - E222871







**MATERIALS ←RoHS COMPLIANT**



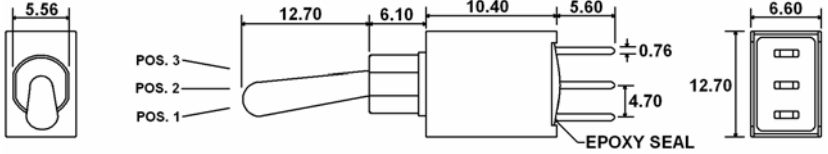

Actuator	Brass, Chrome Plated
Housing	4/6 Nylon, Glass Filled, Flame Retardant Heat Stabilized, UL94V-0
Support Bracket	Steel, Tin Plated
Contacts	Copper Alloy, Silver Plated
Terminals	Copper Alloy, Silver Plated



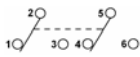
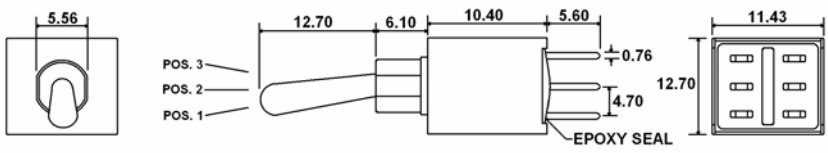

**ORDERING INFORMATION**

<b>Series:</b>	<b>AST</b>	<b>1</b>	<b>1</b>	<b>T</b>	<b>N</b>	<b>H</b>	<b>Q</b>
AST							
<b>Number of Poles:</b>							
1 = SPDT							
2 = DPDT							
3 = 3PDT							
<b>Switch Function:</b>							
1 = ON-NONE-ON							
2 = ON-NONE-(ON)							
3 = ON-OFF-ON							
4 = (ON)-OFF-(ON)							
5 = ON-OFF-(ON)							
6 = ON-ON-ON **Only in DPDT models							
<b>Actuator:</b>							
T = 7.62mm, Std							
S = 12.70mm, Std							
P1 = 7.62mm, Plastic, Anti-Static							
P2 = 12.70mm, Plastic, Anti-Static							
<b>Bushing:</b>							
E = 8.89mm, Threaded ¼-40 UNS-2A							
N = 6.10mm, Non-Threaded							
<b>Terminals:</b>							
B = Solder Lug							
C = PC Pin							
D = Quick Connect							
H = Horizontal Mount, Right Angle PC Pin; <i>HS = Snap-in</i>							
V = Vertical Mount, Right Angle PC Pin; <i>VS = Snap-in</i>							
S20 = PC Pin with Support Bracket; <i>V20 = Snap-in Support Bracket</i>							
S25 = PC Pin with Support Bracket; <i>V25 = Snap-in Support Bracket</i>							
<b>Contacts:</b>							
Q = Silver Plated							
R = Gold Plated							
G = Gold over Silver Plated							

## SWITCH FUNCTION

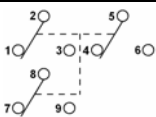
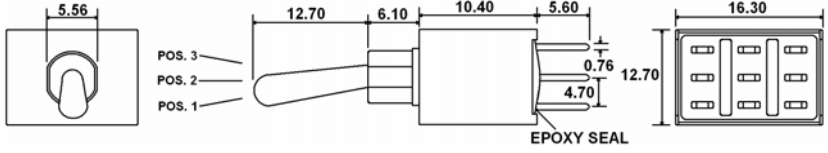
	Function	Toggle Position					
							
		1	ON	NONE			ON
	2	ON	NONE	(ON)			
	3	ON	OFF	ON			
SPDT	4	(ON)	OFF	(ON)			
	5	ON	OFF	(ON)			
Terminals	2-3	---	2-1				

	Function	Toggle Position					
							
		1	ON	NONE			(ON)
	2	ON	NONE	(ON)			
	3	ON	OFF	ON			
DPDT	4	(ON)	OFF	(ON)			
	5	ON	OFF	(ON)			
Terminals	2-3	---	2-1				
6	ON	ON	ON				
Terminals	2-3	2-3	2-1				
	5-6	5-4	5-4				

	Function	Toggle Position					
							
		1	ON	NONE			ON
	2	ON	NONE	(ON)			
	3	ON	OFF	ON			
3PDT	4	(ON)	OFF	(ON)			
	5	ON	OFF	(ON)			
Terminals	2-3	---	2-1				
5-6	---	5-4					
8-9		8-7					

## ACTUATOR OPTIONS

**\*\* Actuator lengths shown with N bushing, subtract 2.15mm for E bushing**

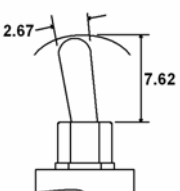
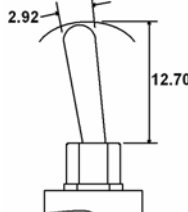
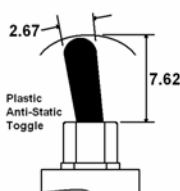
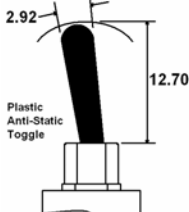
			
<b>T</b>	<b>S</b>	<b>P1</b>	<b>P2</b>

**BUSHING OPTIONS**

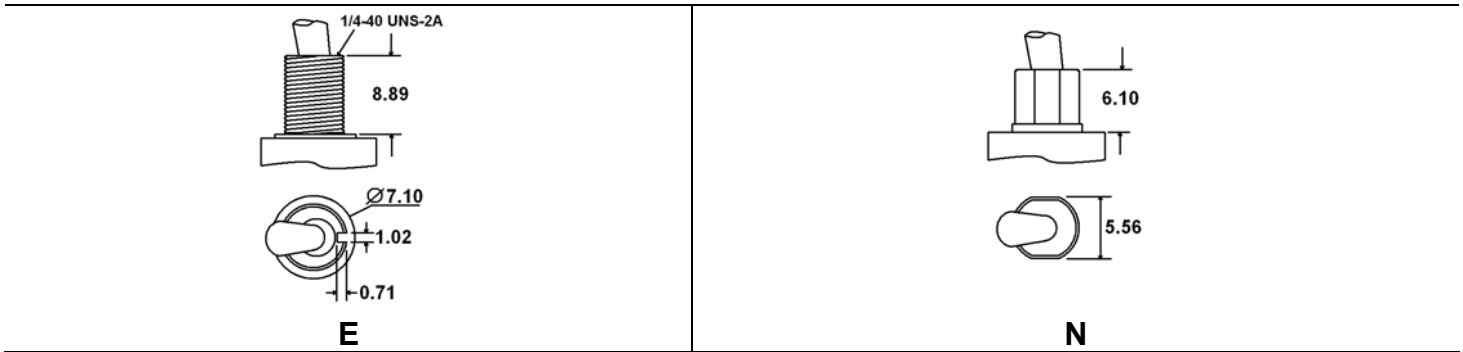

**PANEL MOUNTING**

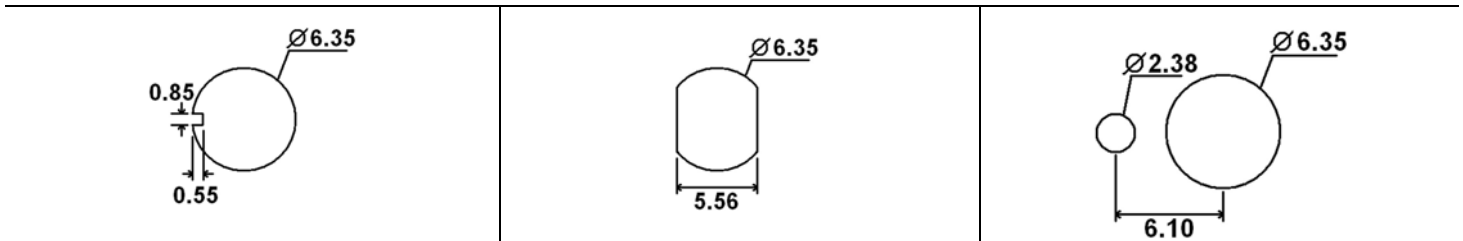

**TERMINAL OPTIONS**

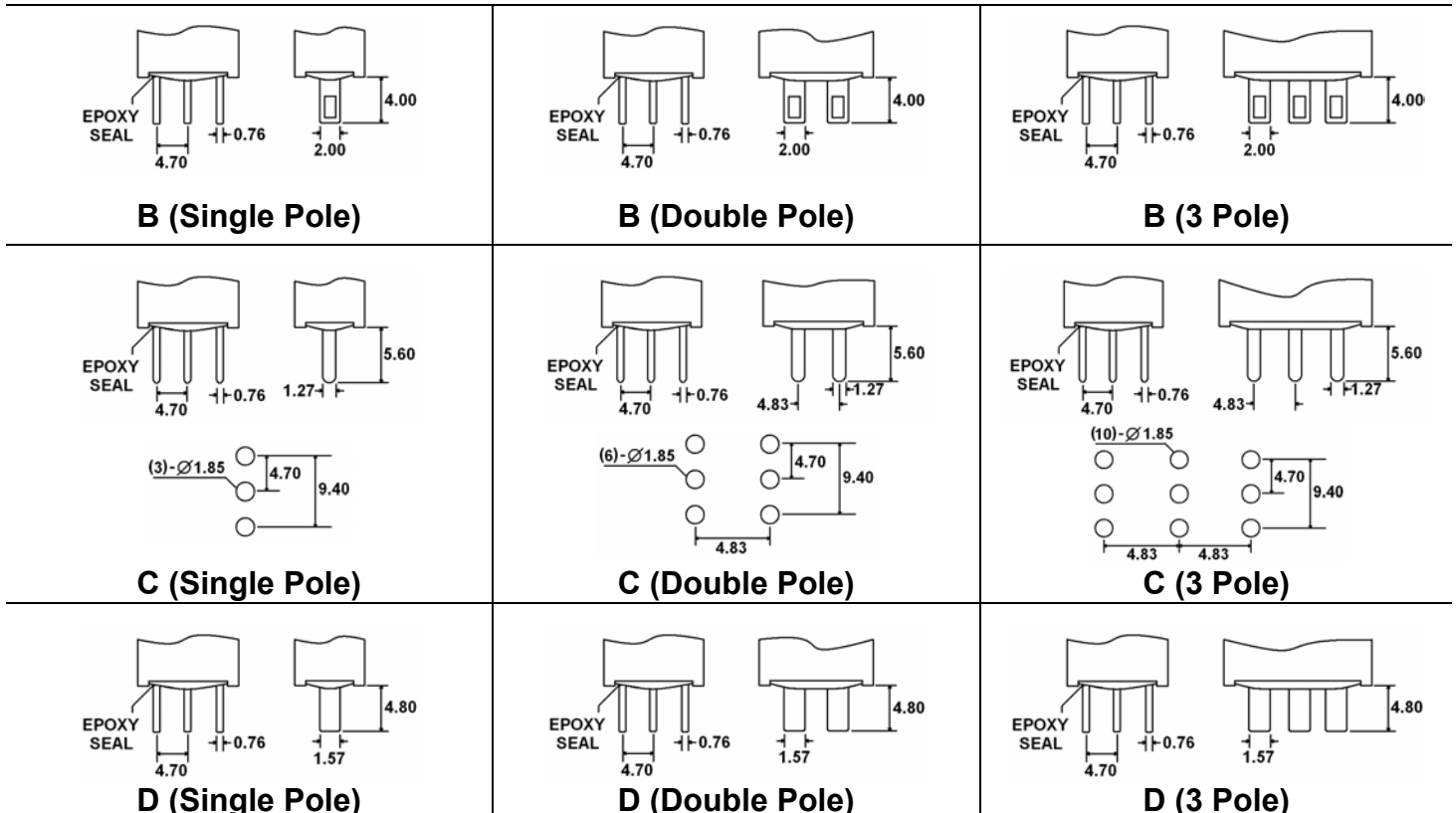

**TERMINAL OPTIONS**

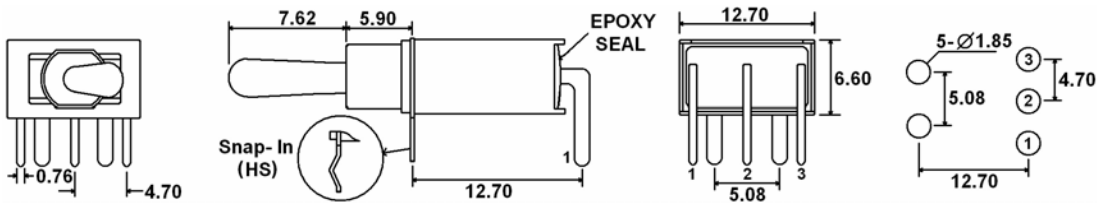

**H (HS – Snap-in) = Horizontal Mount, Right Angle PC Pins (Single Pole)**

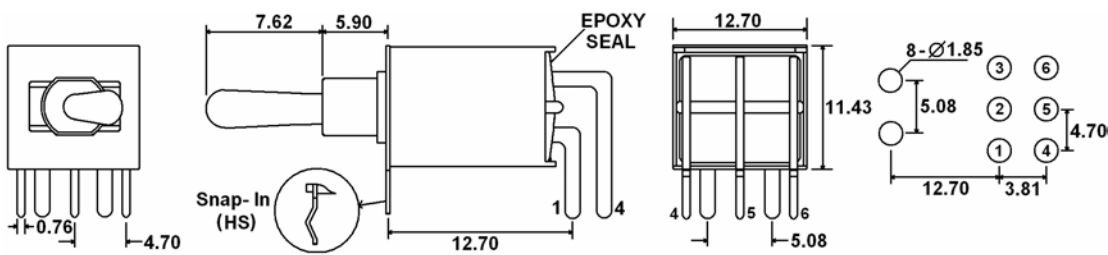

**H (HS – Snap-in) = Horizontal Mount, Right Angle PC Pins (Double Pole)**

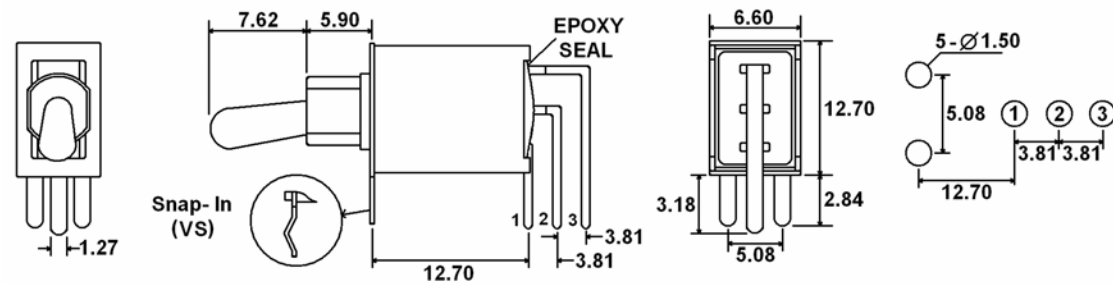

**V (VS – Snap-in) = Vertical Mount, Right Angle PC Pins (Single Pole)**

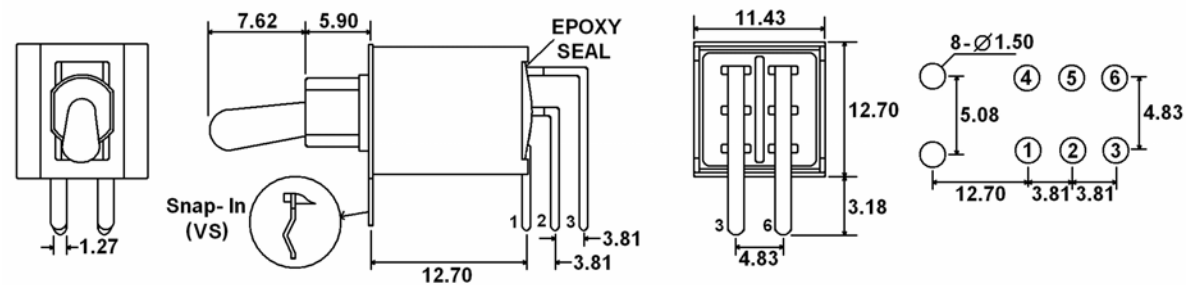

**V (VS – Snap-in) = Vertical Mount, Right Angle PC Pins (Double Pole)**

**TERMINAL OPTIONS**

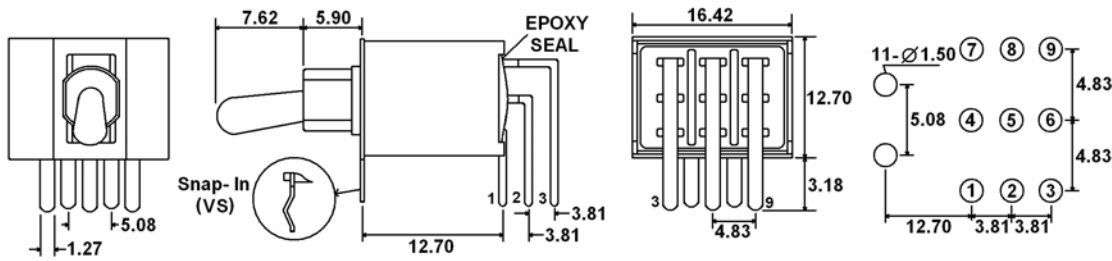

**V (VS – Snap-in) = Vertical Mount, Right Angle PC Pins (Three Pole)**

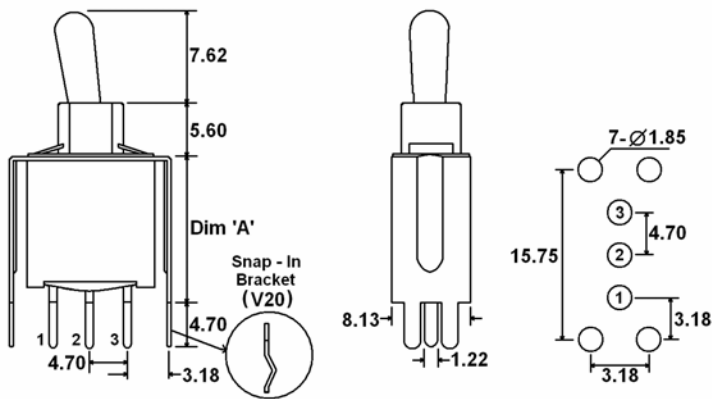

Terminal Option	“A” Dimension
S20-V20	11.68
S25-V25	16.00

**S20/S25 (V20/V25 – Snap-in Bracket) = PC Pins with Support Bracket (Single Pole)**

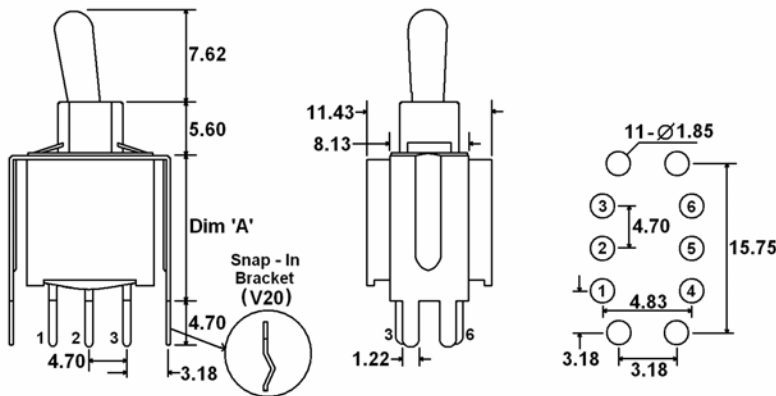

Terminal Option	“A” Dimension
S20-V20	11.68
S25-V25	16.00

**S20/S25 (V20/V25 – Snap-in Bracket) = PC Pins with Support Bracket (Double Pole)**

## TERMINAL OPTIONS

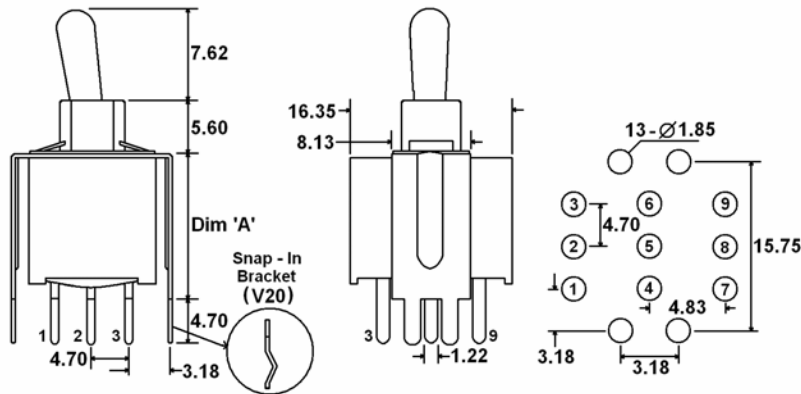

Terminal Option	"A" Dimension
S20-V20	11.68
S25-V25	16.00

**S20/S25 (V20/V25 – Snap-in Bracket) = PC Pins with Support Bracket (Three Pole)**

## CONTACT OPTIONS

Designator	Contact Material	Terminal Material	Electrical Ratings
Q	Silver Plating	Silver Plating	5A @ 120VAC, 28VDC; 2A @ 250VAC
R	Gold over Nickel Plating	Gold over Nickel Plating	.4 VA max @ 20VAC or VDC max
G	Gold over Silver Plating	Gold over Silver Plating	.4 VA max @ 20VAC or VDC max or 5A @ 120VAC, 28VDC; 2A @ 250VAC

## HARDWARE **\*\*Two hex nuts, one lock washer, & one locking ring supplied standard with threaded bushings**

<p>Hex Nut</p>	<p>Lock Washer</p>	<p>Locking Ring</p>	<p>Dress Nut</p>	<p>Knurled Nut</p>	<p>Knurled Nut</p>
----------------	--------------------	---------------------	------------------	--------------------	--------------------

**\*\*For use with E Bushing**