

January 29, 1998

TEL:805-498-2111 FAX:805-498-3804 WEB:http://www.semtech.com

HIGH CURRENT, HIGH DENSITY, ISOLATED, SILICON POWER RECTIFIER DO5 STUD

QUICK REFERENCE DATA

- Low thermal impedance
- Small size and low weight
- High current applications
- Isolated for direct heatsink mounting
- High surge ratings

- $V_R = 150V - 1000V$
- $I_F = 60A$
- $t_{rr} = 30nS - 2\mu S$
- $I_{FSM} \geq 500A$

ABSOLUTE MAXIMUM RATINGS

Device Type	Working Reverse Voltage (V_{RWM})	Average Rectified Current ($I_{F(AV)}$) @ T_{mb}			1 Cycle Surge I_{FSM} @ $t_p = 8.3mS$		Repetitive Surge (I_{FRM}) @ 25 °C	Operating & Storage Temperature Range	
		@ 55°C	100°C	125°C	@ 25 °C	@ 100°C		(T_{OP})	(T_{STG})
		Amps	Amps	Amps	Amps	Amps		Amps	°C
SET050203	1000	60	44	32	500	400	100	-55 to +175	
SET050219	1000	40	32	24	500	320	60	-55 to +175	
SET050212	600	60	44	32	500	400	100	-55 to +175	
SET050204	400	60	44	32	500	320	100	-55 to +175	
SET050211	150	60	40	28	580	500	96	-55 to +150	

$R_{\theta JMB} = 0.75^{\circ}C/W$ for all varieties, other configurations available see next page for details

MECHANICAL

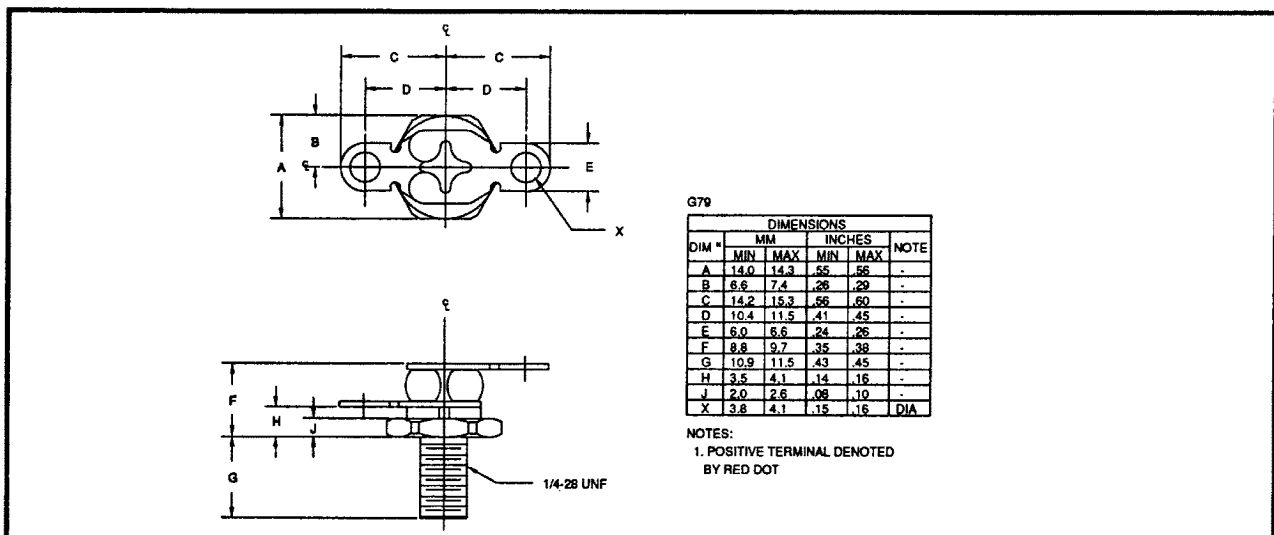

January 29, 1998

ELECTRICAL CHARACTERISTICS

Device Type	Maximum Leakage Current @ V_{RWM}		Maximum Forward Voltage @ 36.0 A	Maximum Reverse Recovery Time
	$T_j = 25^\circ\text{C}$	$T_j = 100^\circ\text{C}$		
	μA	μA	Volts	nS
SET050203	4.0	80	1.2	2000
SET050219	4.0	100	2.2	150
SET050212	4.0	80	1.2	2000
SET050204	4.0	80	1.5	150
SET050211	40.0	2mA	1.1	30

OTHER CONFIGURATIONS

The Part Numbers Shown in this data Sheet are Isolated with the cathode at the stud end of the device. Part numbers for other configurations are shown below:

Isolated Cathode to Stud	Isolated Anode to Stud	Non-Isolated Cathode to Stud	Non-Isolated Anode to Stud
SET050203	SET050403	SET050103	SET050303
SET050219	SET050419	SET050119	SET050319
SET050212	SET050412	SET050112	SET050312
SET050204	SET050404	SET050104	SET050304
SET050211	SET050411	SET050111	SET050311

January 29, 1998

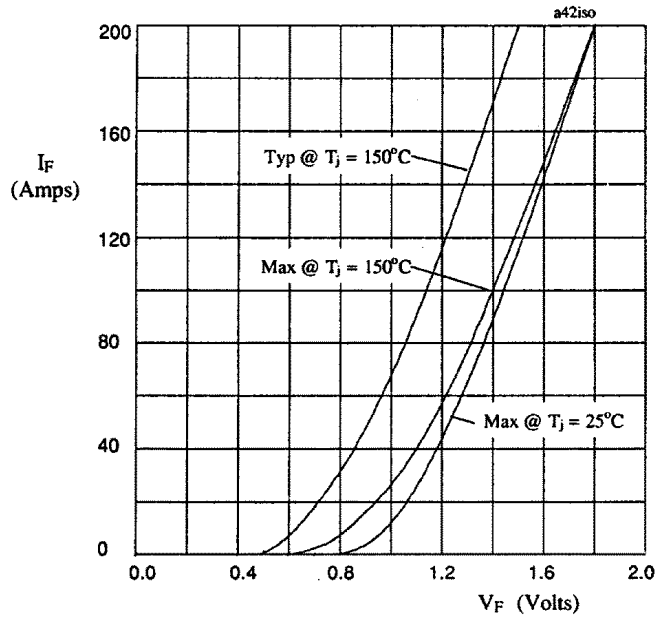

Figure 1. Forward voltage drop as a function of forward current for SET05**03 & SET05**12.

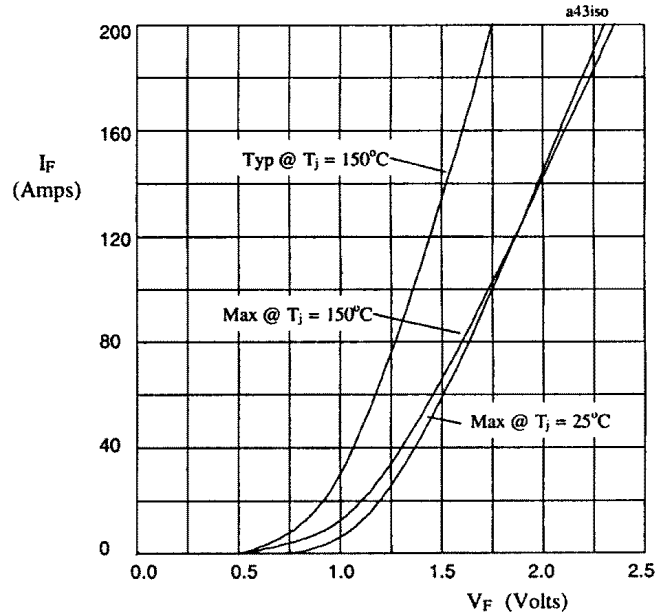

Figure 2. Forward voltage drop as a function of forward current for SET05**04.

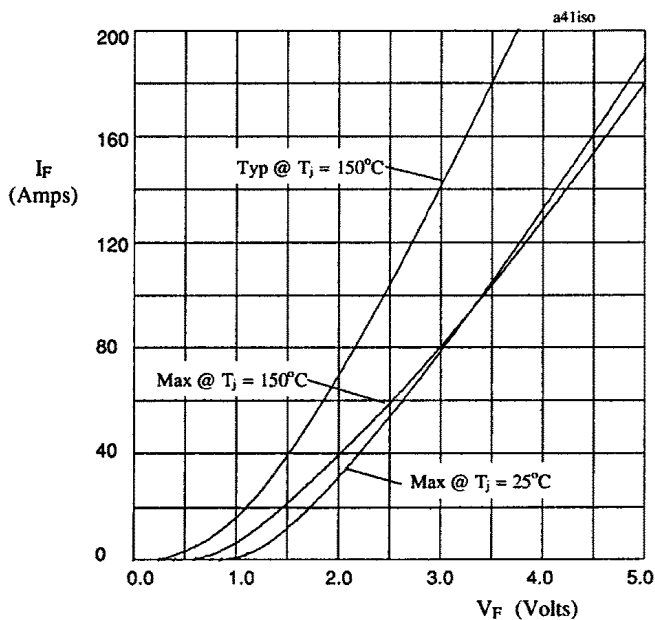

Figure 3. Forward voltage drop as a function of forward current for SET05**19.

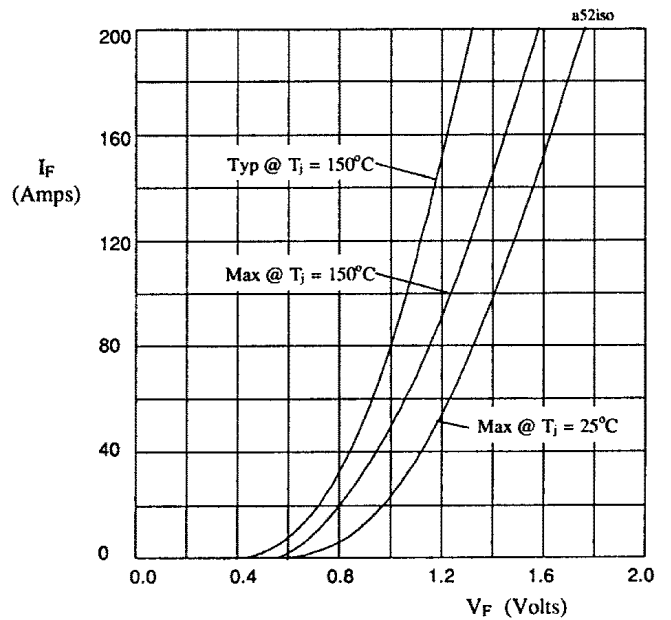

Figure 4. Forward voltage drop as a function of forward current for SET05**11.

January 29, 1998

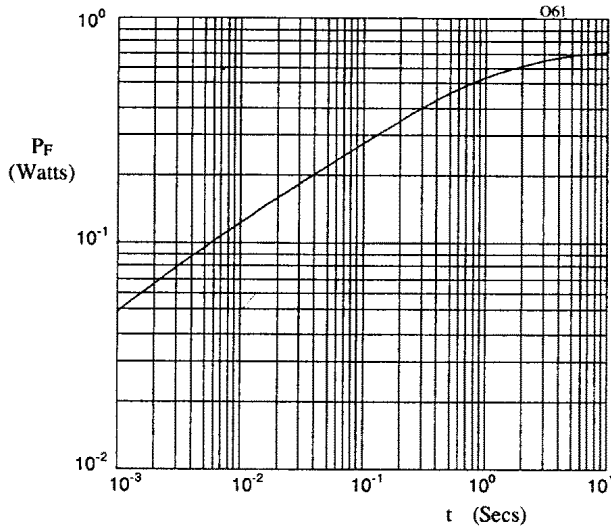

Figure 5. Typical transient thermal impedance characteristic.

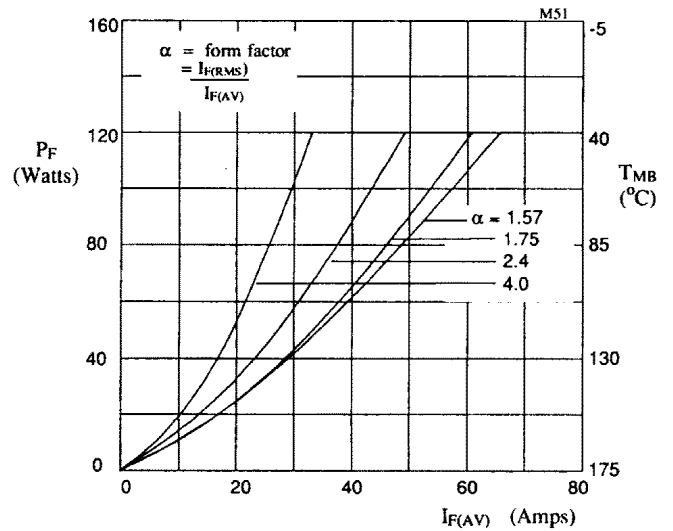

Figure 6. Forward power dissipation and maximum allowable mounting base temperature as a function of forward current for sinusoidal operation, for SET05**03 and SET05**12.

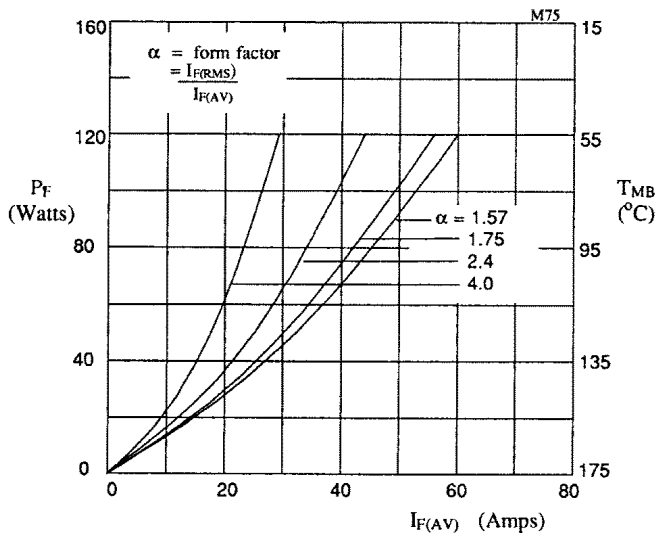

Figure 7. Forward power dissipation and maximum allowable mounting base temperature as a function of forward current for sinusoidal operation, for SET05**04.

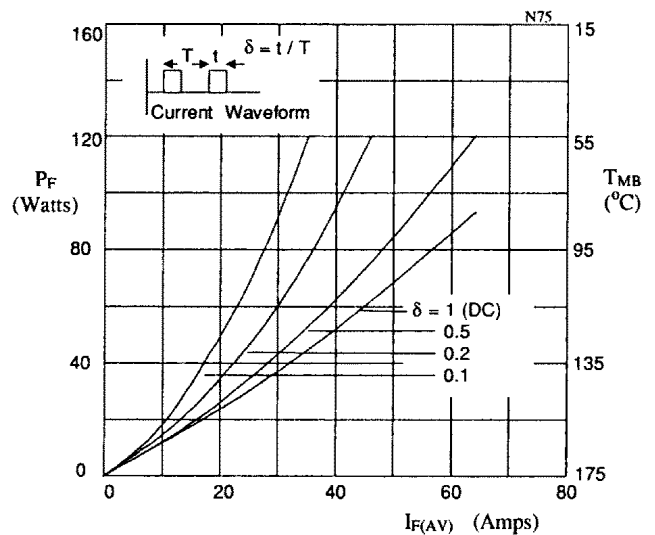

Figure 8. Forward power dissipation and maximum allowable mounting base temperature as a function of forward current for square wave operation, for SET05**04

January 29, 1998

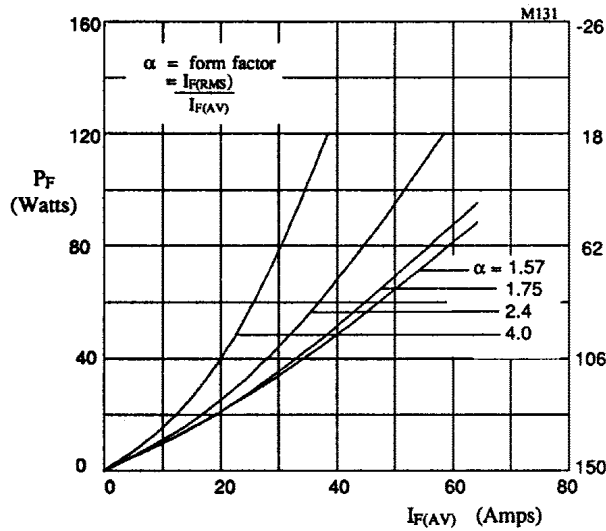

Figure 9. Forward power dissipation and maximum allowable mounting base temperature as a function of forward current for sinusoidal operation, for SET05**11.

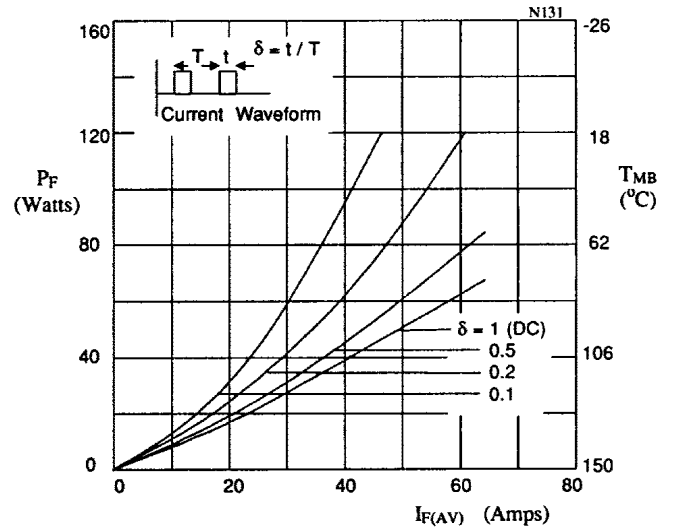

Figure 10. Forward power dissipation and maximum allowable mounting base temperature as a function of forward current for square wave operation, for SET05**11.