

## Series BoardFit4.2 - Power Connectors Male Cable Power Connector 4.20mm Pitch (Single & Dual Row)

### Specifications

Insulation Resistance: 1,000MΩ min.  
 Withstanding Voltage: 1,500V ACrms for 1 minute  
 Contact Resistance: 10mΩ max.  
 Voltage Rating: 600V AC/DC  
 Current Rating: 9A AC/DC  
 Operating Temp. Range: -40°C to +105°C

### Materials and Finish

Insulator: Nylon66, UL94V-2 rated  
 Contact: Brass, Tin Plated  
 Crimp Terminals: Brass, Tin Plated

### Features

- Designed for high current/high density applications
- For wire-to-wire and wire-to-board applications
- Fully insulated terminals
- Low engagement terminals
- Locking function

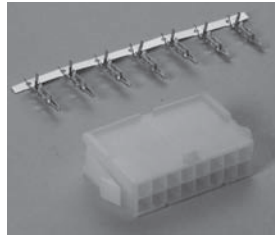

### Part Number (Details)

**P4CP - 4 \* - C1 - LL - B**

Series

Pin Count

S = Single Row (3 to 6)  
 D = Dual Row (2 to 24)

C1 = 180° Crimp

Plating: Mating / Termination Area  
 LL = Tin / Tin

B = Bulk Packaging

### Part Number for Crimp Contacts

**P4CP-Contact - \***

Wire gauge

- 1 = AWG 24-26 Brass
- 2 = AWG16-22 Brass
- 3 = AWG 24-26 Phosphor Bronze
- 4 = AWG 16-22 Phosphor Bronze

### Outline Dimensions Single Row

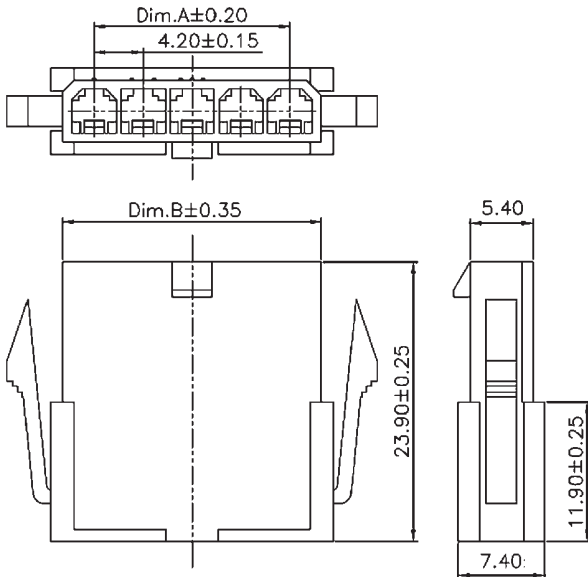

### Outline Dimensions Dual Row

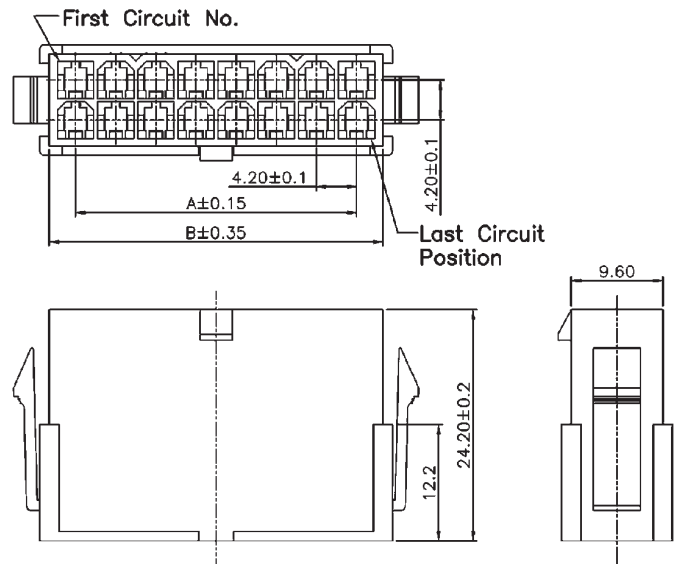

### Outline Dimensions Crimp Contacts

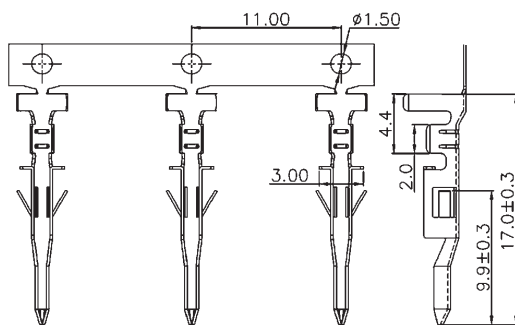

### Single Row

| Part Number     | Pin Count | A     | B     |
|-----------------|-----------|-------|-------|
| P4CP-3S-C1-LL-B | 3         | 8.40  | 13.80 |
| P4CP-4S-C1-LL-B | 4         | 12.60 | 18.00 |
| P4CP-5S-C1-LL-B | 5         | 16.80 | 22.20 |
| P4CP-6S-C1-LL-B | 6         | 21.00 | 26.40 |

### Dual Row

| Part Number       | Pin Count | A     | B     |
|-------------------|-----------|-------|-------|
| P4CP-2D-C1-LL-B   | 2         | -     | 5.50  |
| P4CP-4D-C1-LL-B   | 4         | 4.20  | 9.70  |
| P4CP-6D-C1-LL-B   | 6         | 8.40  | 13.90 |
| P4CP-8D-C1-LL-B   | 8         | 12.60 | 18.10 |
| P4CP-10D-C1-LL-B  | 10        | 16.80 | 22.30 |
| P4CP-12D-C1-LL-B  | 12        | 21.00 | 26.50 |
| P4CP-14-D-C1-LL-B | 14        | 25.20 | 30.70 |
| P4CP-16-D-C1-LL-B | 16        | 29.40 | 34.90 |
| P4CP-18-D-C1-LL-B | 18        | 33.60 | 39.10 |
| P4CP-20-D-C1-LL-B | 20        | 37.80 | 43.30 |
| P4CP-22-D-C1-LL-B | 22        | 42.00 | 47.50 |
| P4CP-24-D-C1-LL-B | 24        | 46.20 | 51.70 |

B-t-B and B-t-C, Power Connectors

### Specifications

Insulation Resistance: 1,000MΩ min.  
 Withstanding Voltage: 1,500V ACrms for 1 minute  
 Contact Resistance: 10mΩ max.  
 Voltage Rating: 600V AC/DC  
 Current Rating: 9A AC/DC  
 Operating Temp. Range: -40°C to +105°C

### Materials and Finish

Insulator: Nylon66, UL94V-2 rated  
 Contact: Brass, Tin Plated  
 Crimp Terminals: Brass, Tin Plated

### Features

- Designed for high current/high density applications
- For wire-to-wire and wire-to-board applications
- Fully insulated terminals
- Low engagement terminals
- Locking function

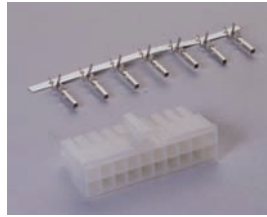

### Part Number (Details)

**P4CS - 4 \* - C1 - LL - B**

Series: P4CS  
 Pin Count: 4 \*  
 S = Single Row (3 to 6)  
 D = Dual Row (2 to 24)  
 C1 = 180° Crimp  
 Plating: Mating / Termination Area  
 LL = Tin / Tin  
 B = Bulk Packaging

### Part Number for Crimp Contacts

**P4CS-Contact - \***  
 Wire gauge  
 1 = AWG 24-26  
 2 = AWG16-22

### Outline Dimensions Single Row

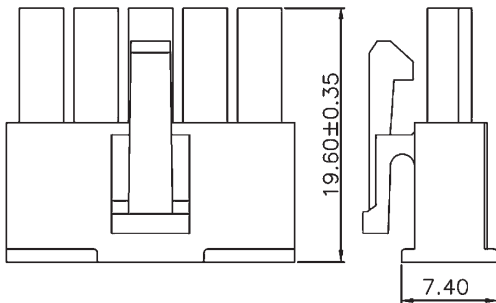
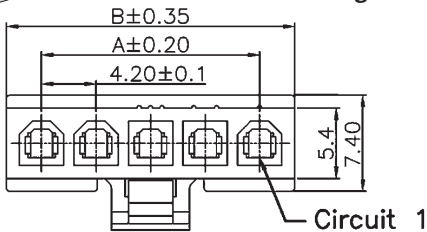

### Outline Dimensions Dual Row

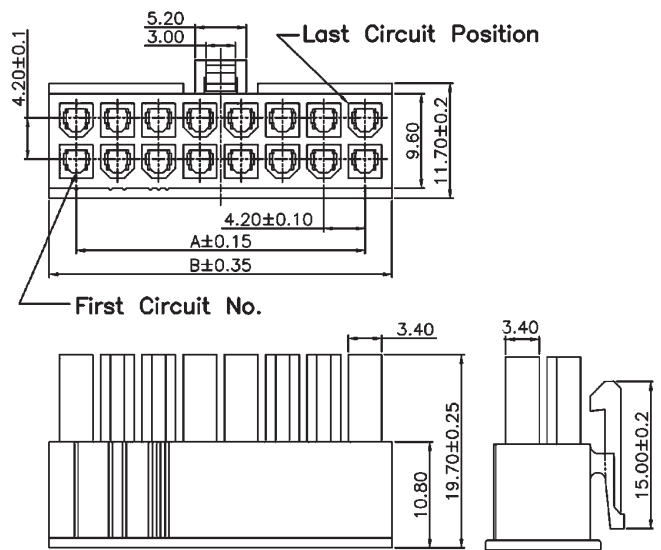

### Outline Dimensions Crimp Contacts

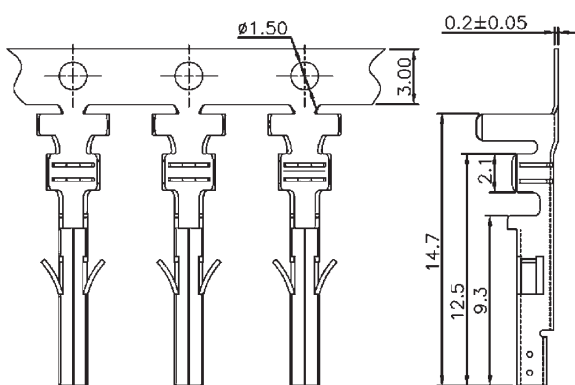

Details for 2 and 4 pins

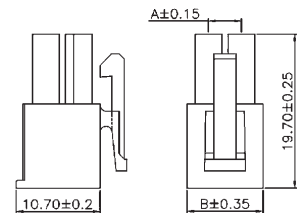

### Dual Row

| Part Number      | Pin Count | A     | B     |
|------------------|-----------|-------|-------|
| P4CS-2D-C1-LL-B  | 2         | -     | 5.50  |
| P4CS-4D-C1-LL-B  | 4         | 4.20  | 9.70  |
| P4CS-6D-C1-LL-B  | 6         | 8.40  | 13.90 |
| P4CS-8D-C1-LL-B  | 8         | 12.60 | 18.10 |
| P4CS-10D-C1-LL-B | 10        | 16.80 | 22.30 |
| P4CS-12D-C1-LL-B | 12        | 21.00 | 26.50 |
| P4CS-14D-C1-LL-B | 14        | 25.20 | 30.70 |
| P4CS-16D-C1-LL-B | 16        | 29.40 | 34.90 |
| P4CS-18D-C1-LL-B | 18        | 33.60 | 39.10 |
| P4CS-20D-C1-LL-B | 20        | 37.80 | 43.30 |
| P4CS-22D-C1-LL-B | 22        | 42.00 | 47.50 |
| P4CS-24D-C1-LL-B | 24        | 46.20 | 51.70 |

### Single Row

| Part Number     | Pin Count | A     | B     |
|-----------------|-----------|-------|-------|
| P4CS-3S-C1-LL-B | 3         | 8.40  | 13.80 |
| P4CS-4S-C1-LL-B | 4         | 12.60 | 18.00 |
| P4CS-5S-C1-LL-B | 5         | 16.80 | 22.20 |
| P4CS-6S-C1-LL-B | 6         | 21.00 | 26.40 |

## Series BoardFit4.2 - Power Connectors 180° and 90° Male Header 4.20mm Pitch (Dual Row) TH

### Specifications

Insulation Resistance: 1,000MΩ min.  
 Withstanding Voltage: 1,500V ACrms for 1 minute  
 Contact Resistance: 10mΩ max.  
 Voltage Rating: 600V AC/DC  
 Current Rating: 9A AC/DC  
 Operating Temp. Range: -40°C to +105°C

### Materials and Finish

Insulator: Nylon66, UL94V-2 rated  
 Contact: Brass, Tin Plated

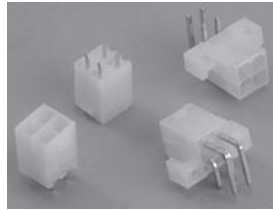

- Designed for high current/high density applications
- For wire-to-wire and wire-to-board applications
- Fully insulated terminals
- Low engagement terminals
- Locking function

### Part Number (Details)

**P4BP - 4 - T\* - LL - B**

|                                    |      |
|------------------------------------|------|
| Series                             | P4BP |
| Pin Count (2 to 24)                | 4    |
| T1 = 180° T9 = 90°                 | T*   |
| Plating: Mating / Termination Area | LL   |
| LL = Tin / Tin                     | LL   |
| B = Bulk Packaging                 | B    |

### Outline Dimensions 90° Dual Row

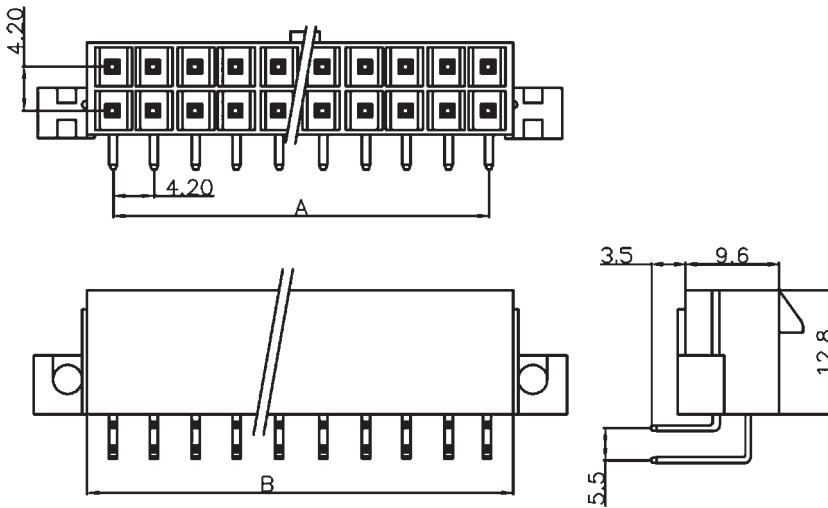

### PCB Layout

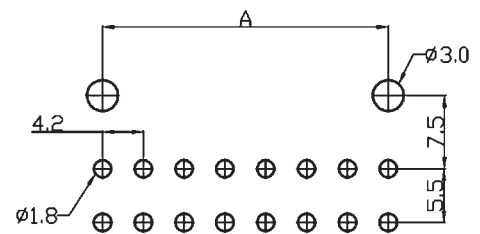

### Outline Dimensions 180° Dual Row

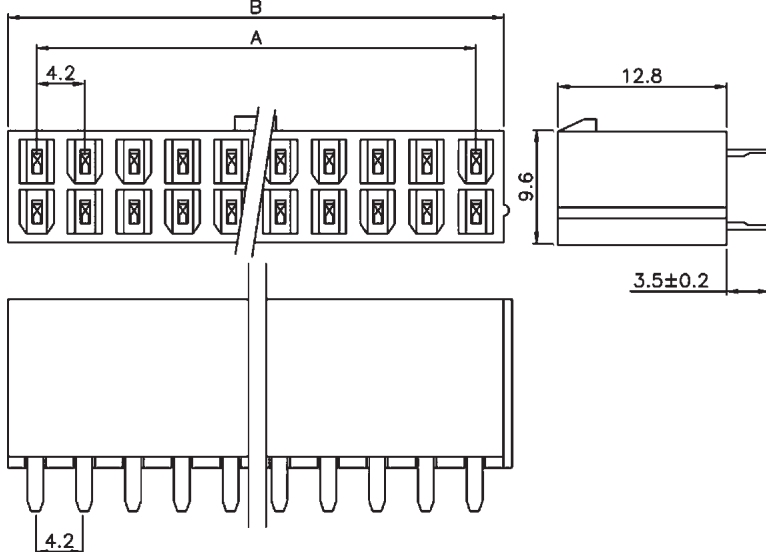

### PCB Layout

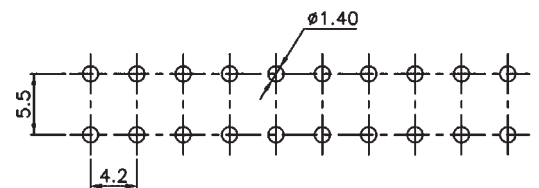

| Part Number     | Pin Count | A     | B     |
|-----------------|-----------|-------|-------|
| P4BP-2-T*-LL-B  | 2         | -     | 5.50  |
| P4BP-4-T*-LL-B  | 4         | 4.20  | 9.70  |
| P4BP-6-T*-LL-B  | 6         | 8.40  | 13.90 |
| P4BP-8-T*-LL-B  | 8         | 12.60 | 18.10 |
| P4BP-10-T*-LL-B | 10        | 16.80 | 22.30 |
| P4BP-12-T*-LL-B | 12        | 21.00 | 26.50 |

| Part Number     | Pin Count | A     | B     |
|-----------------|-----------|-------|-------|
| P4BP-14-T*-LL-B | 14        | 25.20 | 30.70 |
| P4BP-16-T*-LL-B | 16        | 29.40 | 34.90 |
| P4BP-18-T*-LL-B | 18        | 33.60 | 39.10 |
| P4BP-20-T*-LL-B | 20        | 37.80 | 43.50 |
| P4BP-22-T*-LL-B | 22        | 42.00 | 47.50 |
| P4BP-24-T*-LL-B | 24        | 46.20 | 51.70 |