

## Resonant Mode IGBT®

The Thunderbolt IGBT® used in this Resonant Mode Combi is a new generation of high voltage power IGBTs. Using Non-Punch Through Technology, the Thunderbolt IGBT® offers superior ruggedness and ultrafast switching speed.

### Features

- Low Conduction Loss
- Low Gate Charge
- Ultrafast Tail Current shutoff
- Low forward Diode Voltage ( $V_F$ )
- Ultrasoft Recovery Diode

- SSOA Rated
- RoHS Compliant 

### Typical Applications

- Induction Heating
- Welding
- Medical
- High Power Telecom
- Resonant Mode Phase Shifted Bridge

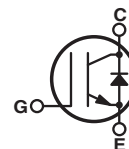

### Maximum Ratings

All Ratings:  $T_C = 25^\circ\text{C}$  unless otherwise specified.

Symbol	Parameter	APT100GT120JRDL	Unit
$V_{CES}$	Collector-Emitter Voltage	1200	Volts
$V_{GE}$	Gate-Emitter Voltage	$\pm 20$	
$I_{C1}$	Continuous Collector Current @ $T_C = 25^\circ\text{C}$	123	Amps
$I_{C2}$	Continuous Collector Current @ $T_C = 100^\circ\text{C}$	67	
$I_{CM}$	Pulsed Collector Current <sup>①</sup>	200	
SSOA	Switching Safe Operating Area @ $T_J = 150^\circ\text{C}$	200A @ 1200V	
$P_D$	Total Power Dissipation	570	Watts
$T_J, T_{STG}$	Operating and Storage Junction Temperature Range	-55 to 150	$^\circ\text{C}$
$T_L$	Max. Lead Temp. for Soldering: 0.063" from Case for 10 Sec.	300	

### Static Electrical Characteristics

Symbol	Characteristic / Test Conditions	Min	Typ	Max	Unit
$V_{(BR)CES}$	Collector-Emitter Breakdown Voltage ( $V_{GE} = 0V, I_C = 5mA$ )	1200	-	-	Volts
$V_{GE(TH)}$	Gate Threshold Voltage ( $V_{CE} = V_{GE}, I_C = 4mA, T_J = 25^\circ\text{C}$ )	4.5	5.5	6.5	
$V_{CE(ON)}$	Collector Emitter On Voltage ( $V_{GE} = 15V, I_C = 100A, T_J = 25^\circ\text{C}$ )	2.7	3.2	3.7	
	Collector Emitter On Voltage ( $V_{GE} = 15V, I_C = 100A, T_J = 125^\circ\text{C}$ )	-	4.0	-	
$I_{CES}$	Collector Cut-off Current ( $V_{CE} = 1200V, V_{GE} = 0V, T_J = 25^\circ\text{C}$ ) <sup>②</sup>	-	-	300	$\mu\text{A}$
	Collector Cut-off Current ( $V_{CE} = 1200V, V_{GE} = 0V, T_J = 125^\circ\text{C}$ ) <sup>②</sup>	-	-	1500	
$I_{GES}$	Gate-Emitter Leakage Current ( $V_{GE} = \pm 20V$ )	-	-	600	nA
$R_{G(int)}$	Integrated Gate Resistor	-	5	-	$\Omega$

 CAUTION: These Devices are Sensitive to Electrostatic Discharge. Proper Handling Procedures Should Be Followed.

## Dynamic Characteristic

APT100GT120JRDL

Symbol	Characteristic	Test Conditions	Min	Typ	Max	Unit
$C_{ies}$	Input Capacitance	$V_{GE} = 0V, V_{CE} = 25V$ $f = 1MHz$	-	6700	-	pF
$C_{oes}$	Output Capacitance		-	6530	-	
$C_{res}$	Reverse Transfer Capacitance		-	4380	-	
$V_{GEP}$	Gate-to-Emitter Plateau Voltage	Gate Charge $V_{GE} = 15V$ $V_{CE} = 600V$ $I_C = 100A$	-	10.0	-	V
$Q_g$	Total Gate Charge		-	685	-	nC
$Q_{ge}$	Gate-Emitter Charge		-	75	-	
$Q_{gc}$	Gate-Collector Charge		-	400	-	
SSOA	Switching Safe Operating Area	$T_J = 150^\circ C, R_G = 1.0\Omega^{(2)}, V_{GE} = 15V,$ $L = 100\mu H, V_{CE} = 1200V$	200			A
$t_{d(on)}$	Turn-On Delay Time	Inductive Switching ( $25^\circ C$ ) $V_{CC} = 800V$ $V_{GE} = 15V$ $I_C = 100A$ $R_G = 4.7\Omega$ $T_J = +25^\circ C$	-	50	-	ns
$t_r$	Current Rise Time		-	100	-	
$t_{d(off)}$	Turn-Off Delay Time		-	630	-	
$t_f$	Current Fall Time		-	36	-	$\mu J$
$E_{on1}$	Turn-On Switching Energy <sup>(4)</sup>		-	TBD	-	
$E_{on2}$	Turn-On Switching Energy <sup>(5)</sup>		-	17600	-	
$E_{off}$	Turn-Off Switching Energy <sup>(6)</sup>	-	7240	-		
$t_{d(on)}$	Turn-On Delay Time	Inductive Switching ( $125^\circ C$ ) $V_{CC} = 800V$ $V_{GE} = 15V$ $I_C = 100A$ $R_G = 4.7\Omega$ $T_J = 125^\circ C$	-	50	-	ns
$t_r$	Current Rise Time		-	100	-	
$t_{d(off)}$	Turn-Off Delay Time		-	710	-	
$t_f$	Current Fall Time		-	37	-	$\mu J$
$E_{on1}$	Turn-On Switching Energy <sup>(4)</sup>		-	TBD	-	
$E_{on2}$	Turn-On Switching Energy <sup>(5)</sup>		-	22380	-	
$E_{off}$	Turn-Off Switching Energy <sup>(6)</sup>	-	10950	-		

## Thermal and Mechanical Characteristics

Symbol	Characteristic / Test Conditions	Min	Typ	Max	Unit
$R_{\theta JC}$	Junction to Case (IGBT)	-	-	0.22	$^\circ C/W$
$R_{\theta JC}$	Junction to Case (DIODE)	-	-	0.80	
$W_T$	Package Weight	-	29.2	-	g
$V_{isolation}$	RMS Voltage (50-60Hz Sinusoidal Waveform from Terminals to Mounting Base for 1 Min.)	2500	-	-	Volts

① Repetitive Rating: Pulse width limited by maximum junction temperature.

② For Combi devices,  $I_{ces}$  includes both IGBT and FRED leakages.

③ See MIL-STD-750 Method 3471.

④  $E_{on1}$  is the clamped inductive turn-on energy of the IGBT only, without the effect of a commutating diode reverse recovery current adding to the IGBT turn-on loss. Tested in inductive switching test circuit shown in figure 21, but with a Silicon Carbide diode.

⑤  $E_{on2}$  is the clamped inductive turn-on energy that includes a commutating diode reverse recovery current in the IGBT turn-on switching loss. (See Figures 21, 22.)

⑥  $E_{off}$  is the clamped inductive turn-off energy measured in accordance with JEDEC standard JESD24-1. (See Figures 21, 23.)

⑦  $R_G$  is external gate resistance not including gate driver impedance.

Microsemi reserves the right to change, without notice, the specifications and information contained herein.

# Typical Performance Curves

APT100GT120JRDL

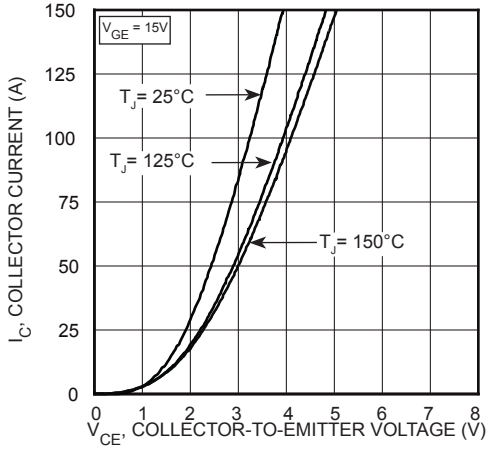

FIGURE 1, Output Characteristics ( $T_J = 25^\circ\text{C}$ )

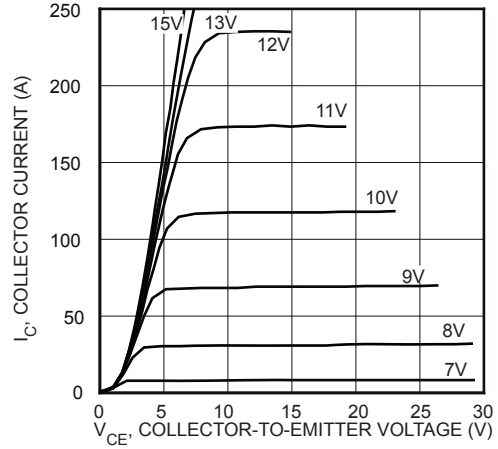

FIGURE 2, Output Characteristics ( $T_J = 25^\circ\text{C}$ )

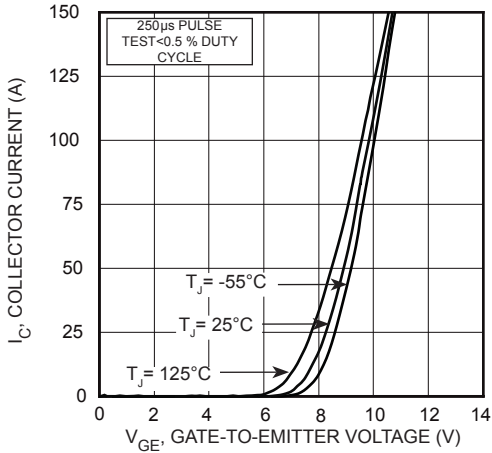

FIGURE 3, Transfer Characteristics

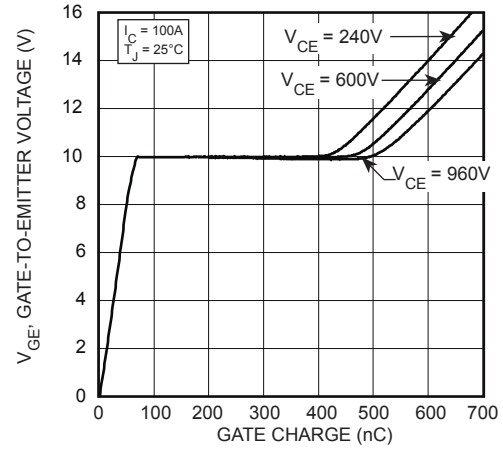

FIGURE 4, Gate charge

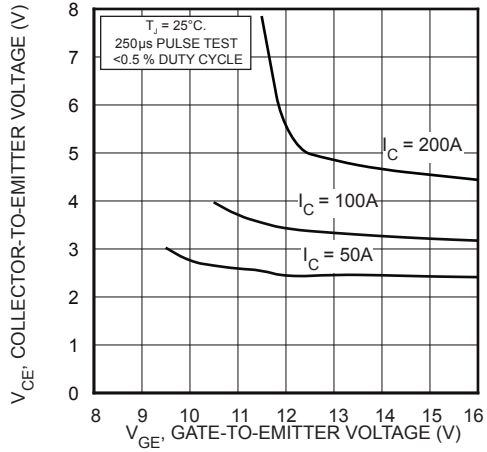

FIGURE 5, On State Voltage vs Gate-to-Emitter Voltage

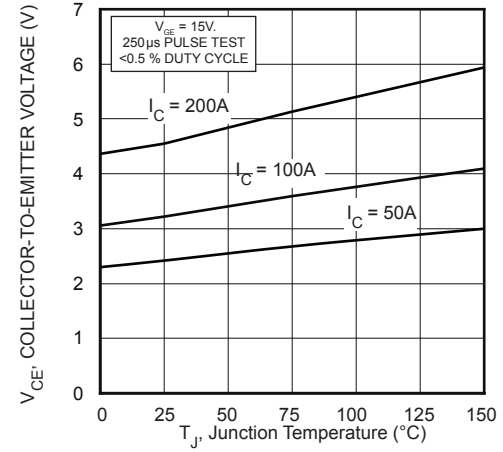

FIGURE 6, On State Voltage vs Junction Temperature

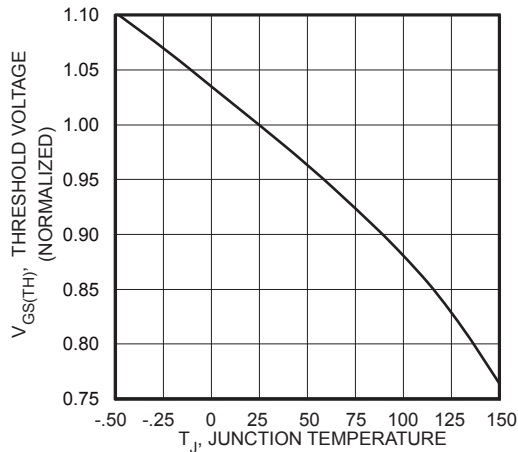

FIGURE 7, Threshold Voltage vs Junction Temperature

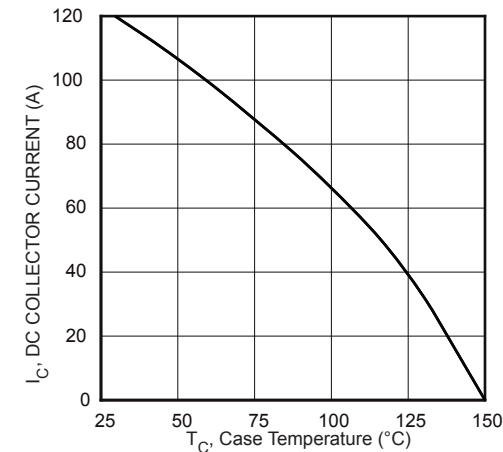

FIGURE 8, DC Collector Current vs Case Temperature

# Typical Performance Curves

APT100GT120JRDL

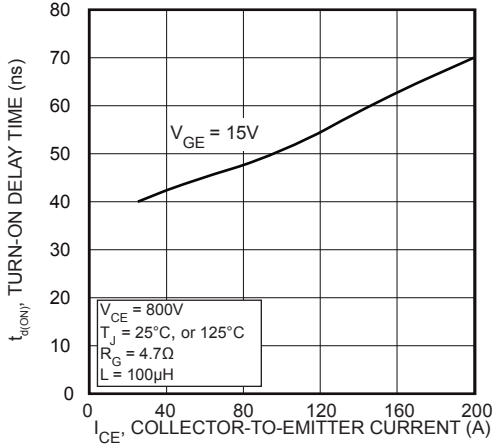

FIGURE 9, Turn-On Delay Time vs Collector Current

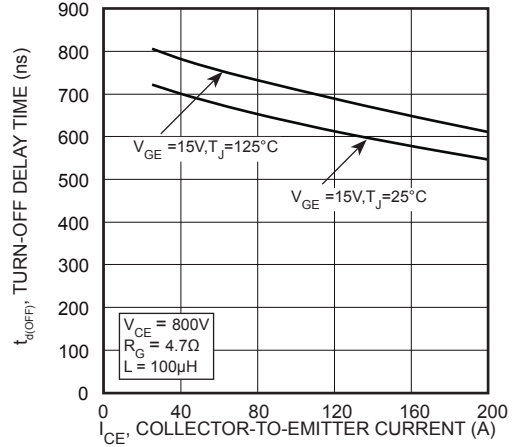

FIGURE 10, Turn-Off Delay Time vs Collector Current

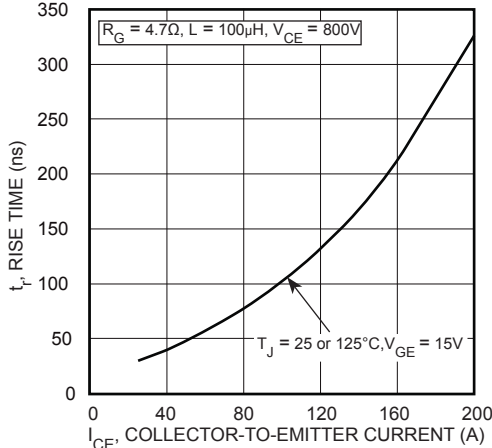

FIGURE 11, Current Rise Time vs Collector Current

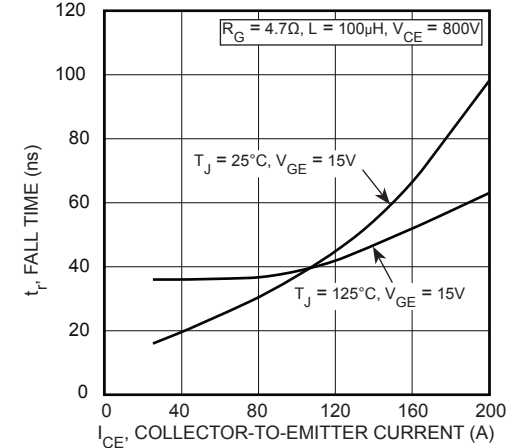

FIGURE 12, Current Fall Time vs Collector Current

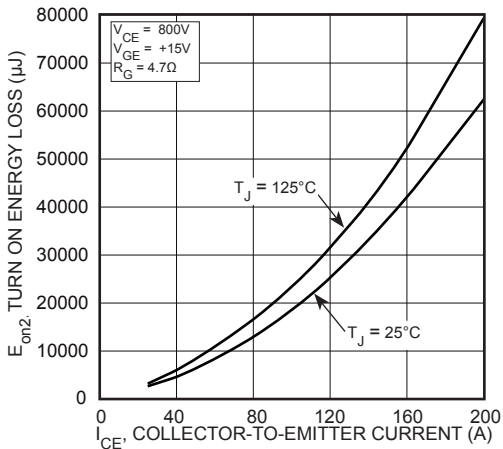

FIGURE 13, Turn-On Energy Loss vs Collector Current

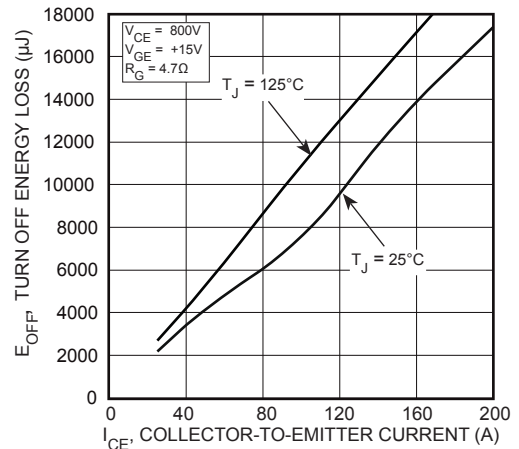

FIGURE 14, Turn-Off Energy Loss vs Collector Current

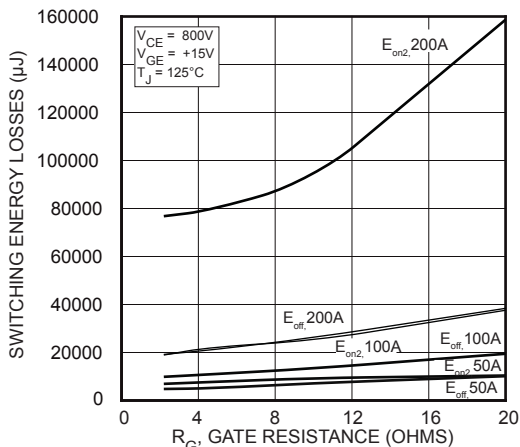

FIGURE 15, Switching Energy Losses vs Gate Resistance

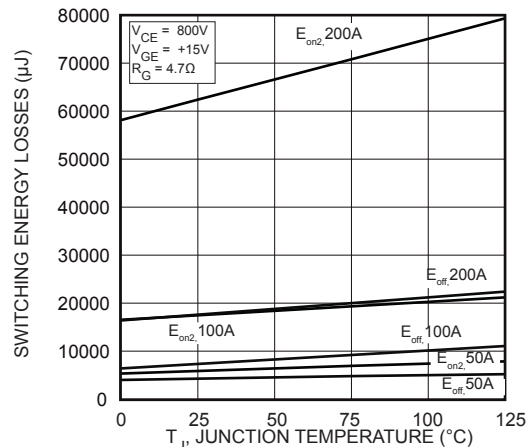

FIGURE 16, Switching Energy Losses vs Junction Temperature

Typical Performance Curves

APT100GT120JRDL

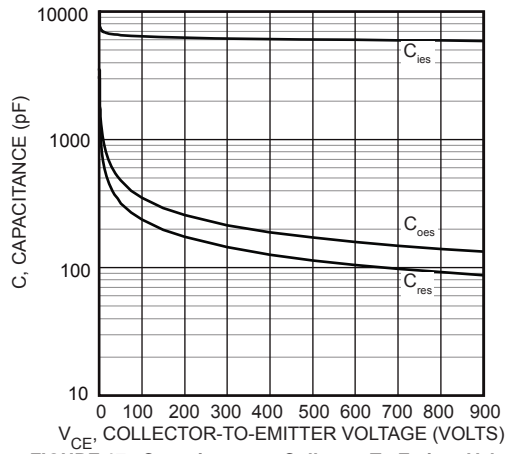

FIGURE 17, Capacitance vs Collector-To-Emitter Voltage

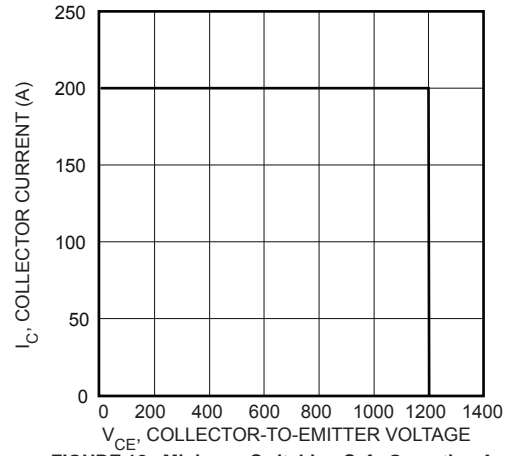

FIGURE 18, Minimum Switching Safe Operating Area

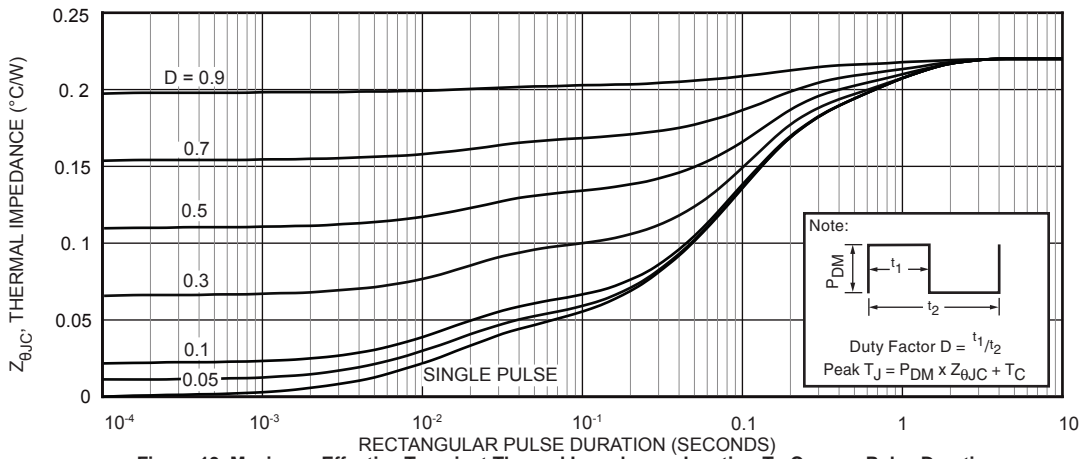

Figure 19, Maximum Effective Transient Thermal Impedance, Junction-To-Case vs Pulse Duration

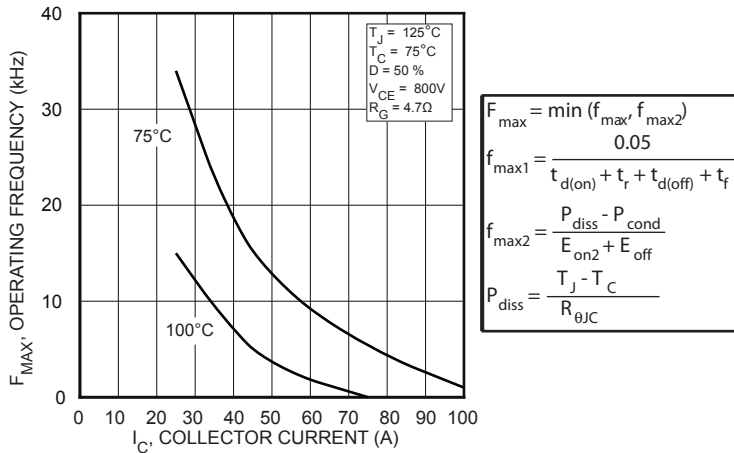

Figure 20, Operating Frequency vs Collector Current

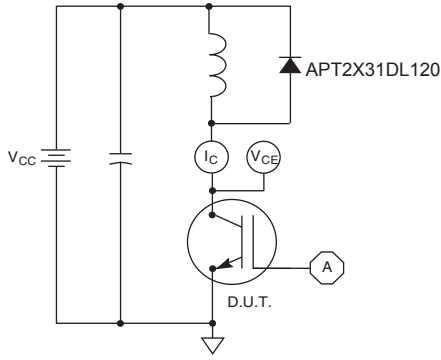

Figure 21, Inductive Switching Test Circuit

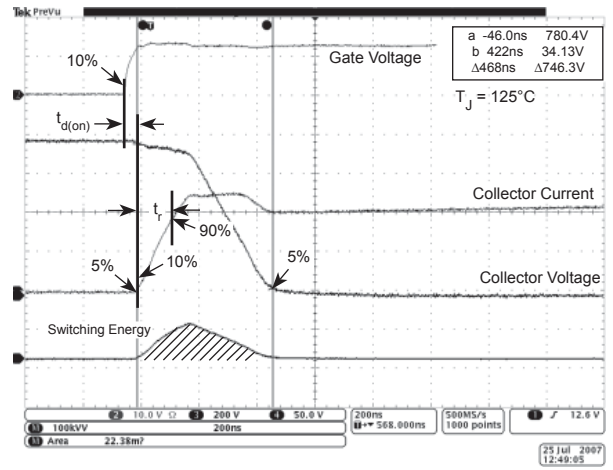

Figure 22, Turn-on Switching Waveforms and Definitions

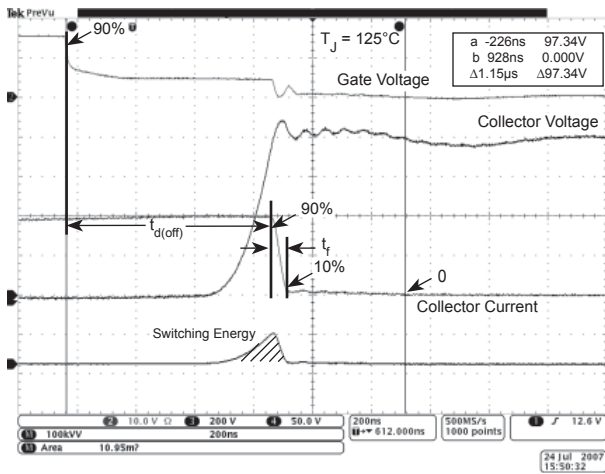

Figure 23, Turn-off Switching Waveforms and Definitions

**ULTRAFAST SOFT RECOVERY ANTI-PARALLEL DIODE**

**MAXIMUM RATINGS**

All Ratings:  $T_C = 25^\circ\text{C}$  unless otherwise specified.

Symbol	Characteristic / Test Conditions	APT100GT120JRDL	Unit
$I_{F(AV)}$	Maximum Average Forward Current ( $T_C = 50^\circ\text{C}$ , Duty Cycle = 0.5)	60	Amps
$I_{F(RMS)}$	RMS Forward Current (Square wave, 50% duty)	90	
$I_{FSM}$	Non-Repetitive Forward Surge Current ( $T_J = 45^\circ\text{C}$ , 8.3 ms)	120	

**STATIC ELECTRICAL CHARACTERISTICS**

Symbol	Characteristic / Test Conditions	Min	Type	Max	Unit	
$V_F$	Forward Voltage				Volts	
		$I_F = 60\text{A}$		1.6		2.1
		$I_F = 120\text{A}$		2.0		
	$I_F = 60\text{A}, T_J = 125^\circ\text{C}$		1.25			

**DYNAMIC CHARACTERISTICS**

Symbol	Characteristic	Test Conditions	Min	Typ	Max	Unit
$t_{rr}$	Reverse Recovery Time	$I_F = 1\text{A}, di_F/dt = -100\text{A}/\mu\text{s}, V_R = 30\text{V}, T_J = 25^\circ\text{C}$	-	61	-	ns
$t_{rr}$	Reverse Recovery Time	$I_F = 60\text{A}, di_F/dt = -200\text{A}/\mu\text{s}, V_R = 800\text{V}, T_C = 25^\circ\text{C}$	-	592	-	
$Q_{rr}$	Reverse Recovery Charge		-	2694	-	nC
$I_{RRM}$	Maximum Reverse Recovery Current		-	9	-	Amps
$t_{rr}$	Reverse Recovery Time	$I_F = 60\text{A}, di_F/dt = -200\text{A}/\mu\text{s}, V_R = 800\text{V}, T_C = 125^\circ\text{C}$	-	793	-	ns
$Q_{rr}$	Reverse Recovery Charge		-	5744	-	nC
$I_{RRM}$	Maximum Reverse Recovery Current		-	13	-	Amps
$t_{rr}$	Reverse Recovery Time	$I_F = 60\text{A}, di_F/dt = -1000\text{A}/\mu\text{s}, V_R = 800\text{V}, T_C = 125^\circ\text{C}$	-	286	-	ns
$Q_{rr}$	Reverse Recovery Charge		-	6182	-	nC
$I_{RRM}$	Maximum Reverse Recovery Current		-	42	-	Amps

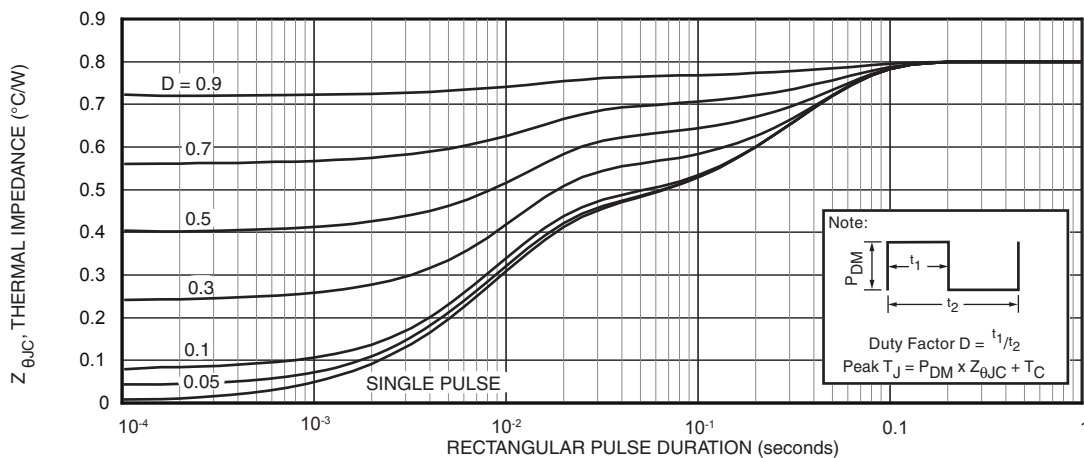

FIGURE 1. MAXIMUM EFFECTIVE TRANSIENT THERMAL IMPEDANCE, JUNCTION-TO-CASE vs. PULSE DURATION

# Typical Performance Curves

APT100GT120JRDL

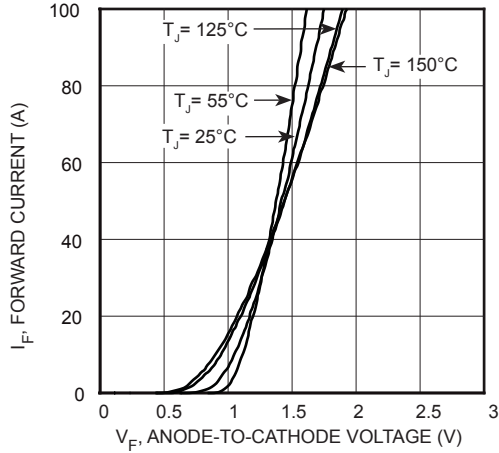

FIGURE 2, Forward Current vs. Forward Voltage

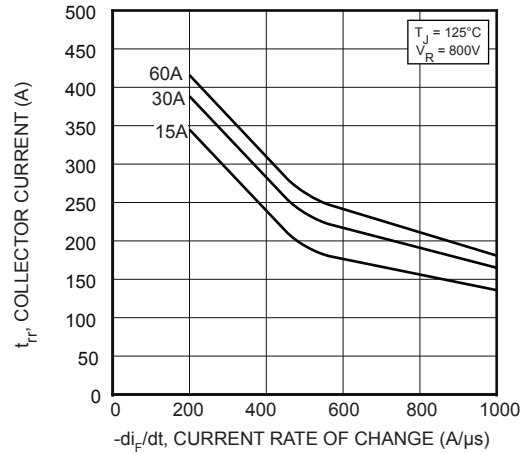

FIGURE 3, Reverse Recovery Time vs. Current Rate of Change

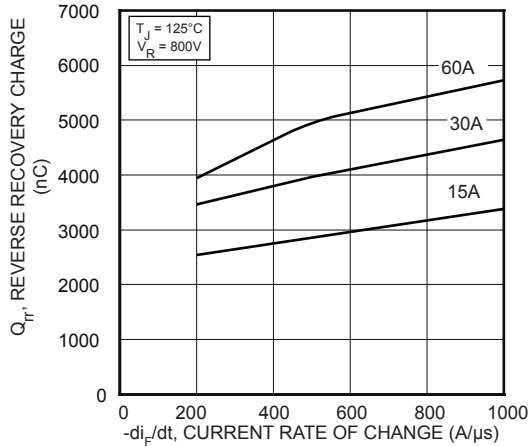

FIGURE 4, Reverse Recovery Charge vs. Current Rate of Change

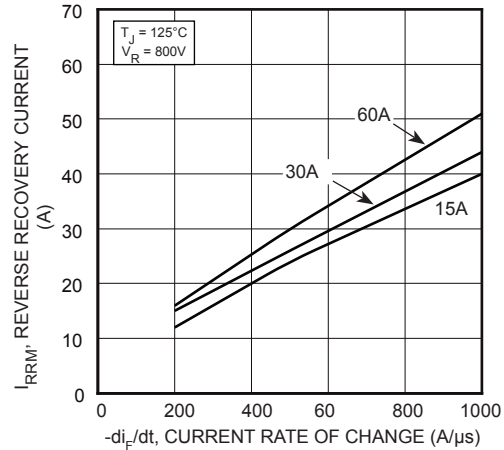

FIGURE 5, Reverse Recovery Current vs. Current Rate of Change

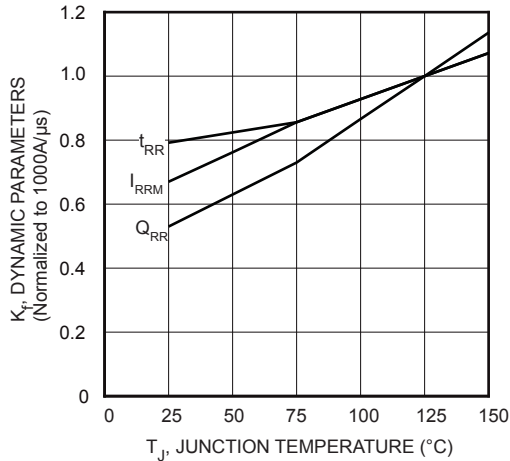

FIGURE 6, Dynamic Parameters vs. Junction Temperature

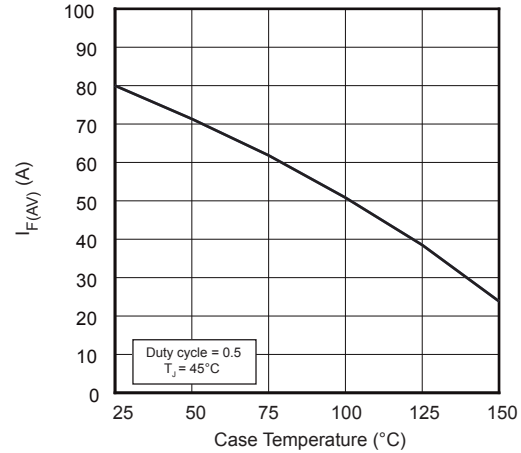

FIGURE 7, Maximum Average Forward Current vs. Case Temperature

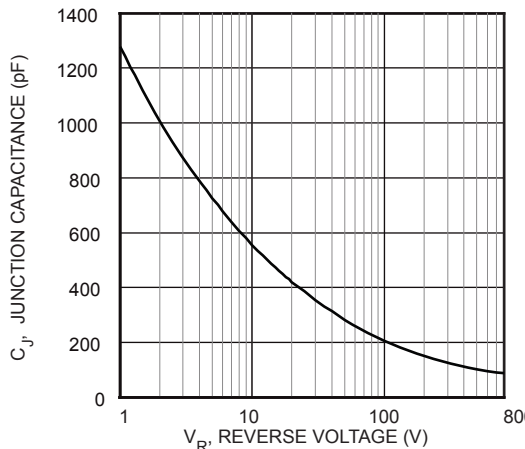

FIGURE 8, Junction Capacitance vs. Reverse Voltage



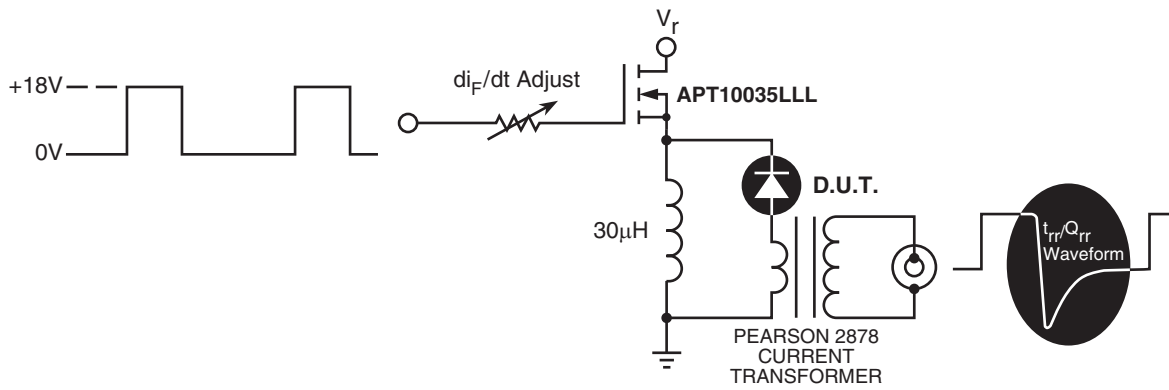

Figure 32, Diode Test Circuit

- 1  $I_F$  - Forward Conduction Current
- 2  $di_F/dt$  - Rate of Diode Current Change Through Zero Crossing.
- 3  $I_{RRM}$  - Maximum Reverse Recovery Current.
- 4  $t_{rr}$  - Reverse Recovery Time, measured from zero crossing where diode current goes from positive to negative, to the point at which the straight line through  $I_{RRM}$  and  $0.25 \cdot I_{RRM}$  passes through zero.
- 5  $Q_{rr}$  - Area Under the Curve Defined by  $I_{RRM}$  and  $t_{rr}$ .

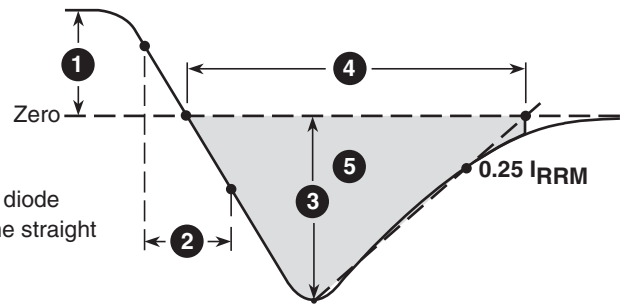
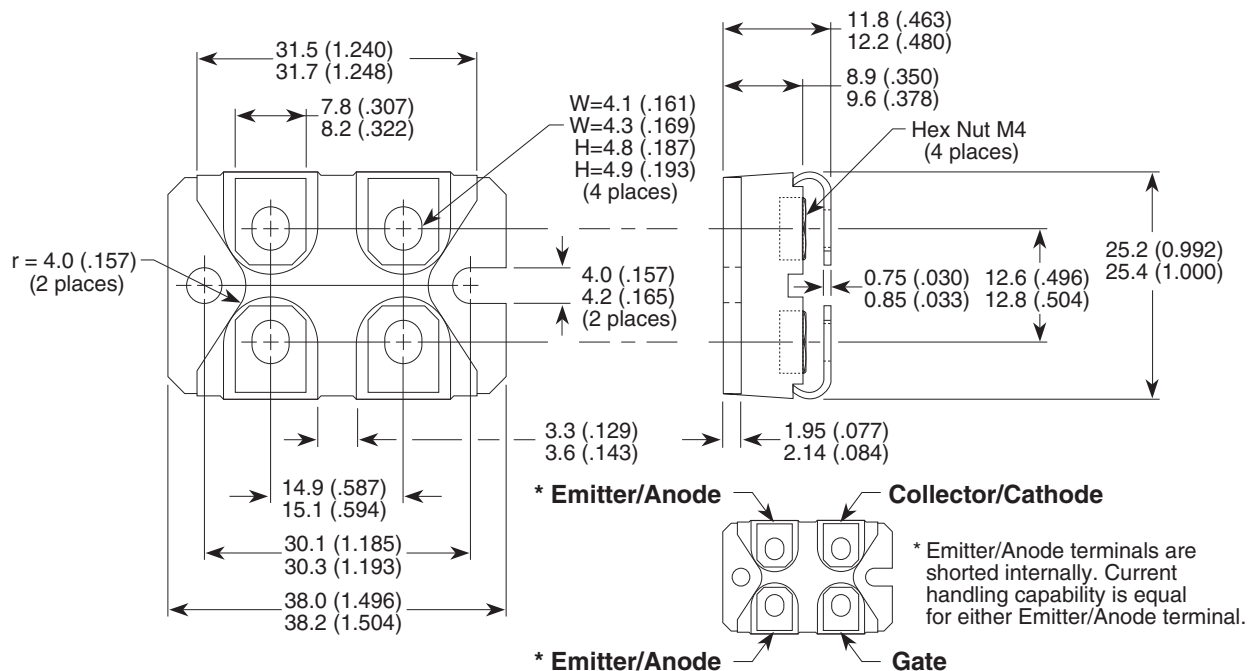

Figure 33, Diode Reverse Recovery Waveform and Definitions

SOT-227 (ISOTOP®) Package Outline



Dimensions in Millimeters and (Inches)