

Features

- Small Size and Low Profile
- Typical Insertion Loss 0.7 dB
- Typical Amplitude Balance 0.3 dB
- 1 Watt Power Handling
- Lead-Free SOT-26 Package
- 100% Matte Tin Plating over Copper
- Halogen-Free “Green” Mold Compound
- 260°C Reflow Compatible
- RoHS* Compliant Version of QH01-0016

Description

M/A-COM’s MAHYCC0001 is an IC-based monolithic power divider using M/A-COM’s GMIC technology in a low cost SOT-26 plastic package. This Quad Hybrid is ideally suited for applications where small size, low insertion loss, superior phase/amplitude tracking and low cost are required. Typical applications include base station switching networks and other cellular applications where size and PCB real estate are at a premium. Available in Tape and Reel.

The MAHYCC0001 is fabricated using a passive-integrated circuit process. The process features full-chip passivation for increased performance and reliability.

Functional Block Diagram

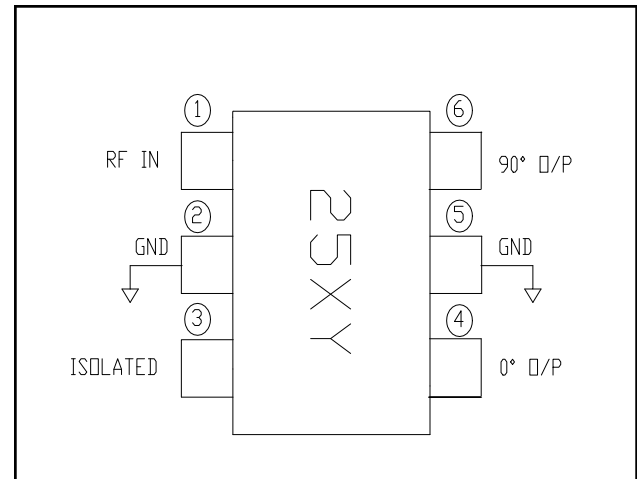

Ordering Information

Part Number	Package
MAHYCC0001	Bulk Packaging
MAHYCC0001-TR	1000 piece reel
MAHYCC0001-TB	Sample Test Board

Note: Reference Application Note M513 for reel size information.

Pin Configuration

Pin No.	Function	Pin No.	Function
1	RF IN	4	0° OUTPUT
2	GND	5	GND
3	ISOLATED	6	90° OUTPUT

* Restrictions on Hazardous Substances, European Union Directive 2002/95/EC.

Electrical Specifications: $T_A = 25^\circ\text{C}$, $Z_0 = 50\Omega$

Parameter	Units	Min	Typ	Max
Insertion Loss above 3.0 dB	dB	—	0.7	1.2
Isolation	dB	14	17	—
VSWR	—	—	1.3:1	1.5:1
Input	—	—	1.4:1	1.6:1
RF1, RF2 Outputs	—	—	—	—
Amplitude Balance	dB	—	0.4	0.9
Phase Balance	Deg	—	1.5	6

Absolute Maximum Ratings ^{1,2}

Parameter	Absolute Maximum
Input Power ³	1 W CW
Operating Temperature	-40°C to +85°C
Storage Temperature	-65°C to +150°C

1. Exceeding any one or combination of these limits may cause permanent damage to this device.
2. M/A-COM does not recommend sustained operation near these survivability limits.
3. With internal load dissipation of 0.125 W Maximum.

Handling Procedures

Please observe the following precautions to avoid damage:

Static Sensitivity

GMIC Circuits are sensitive to electrostatic discharge (ESD) and can be damaged by static electricity. Proper ESD control techniques should be used when handling these devices.

Recommended PCB Configuration

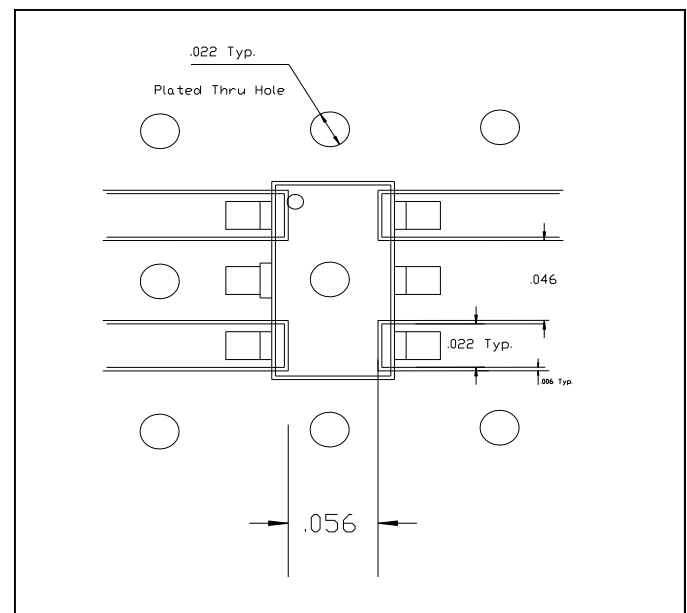

Typical Performance Curves @ 25°C

Insertion Loss vs. Frequency

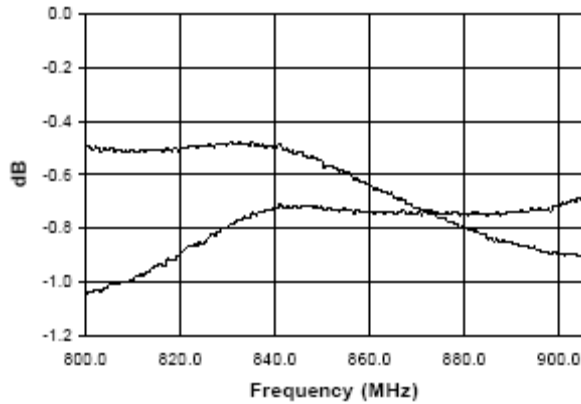

Amplitude Balance vs. Frequency

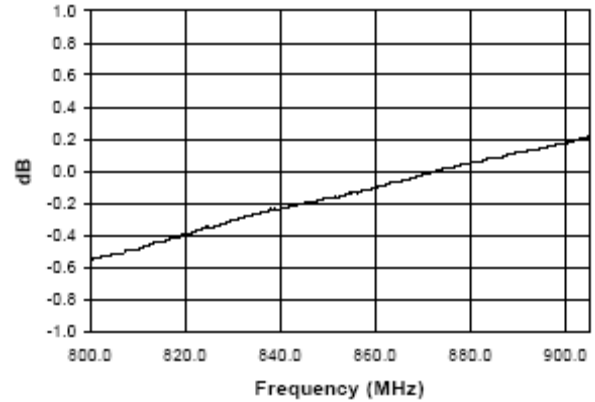

VSWR vs. Frequency

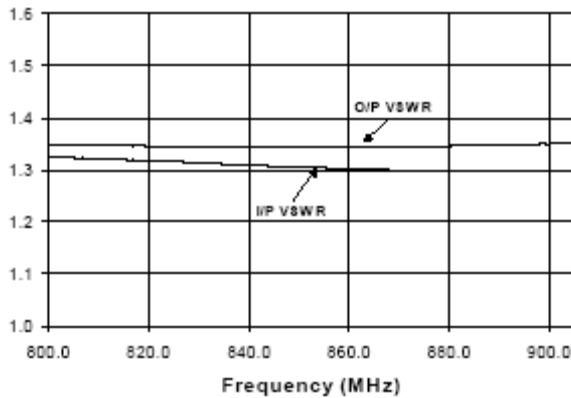

Isolation vs. Frequency

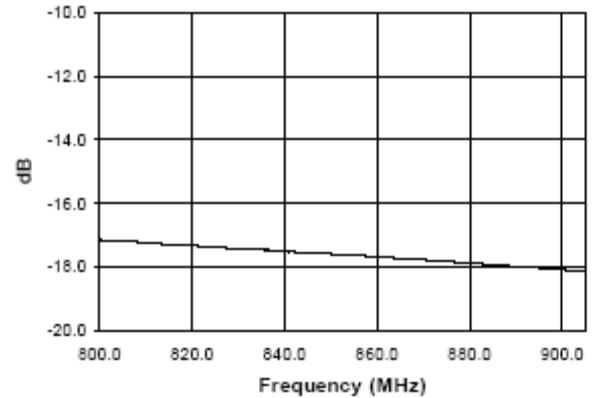

Phase Balance vs. Frequency

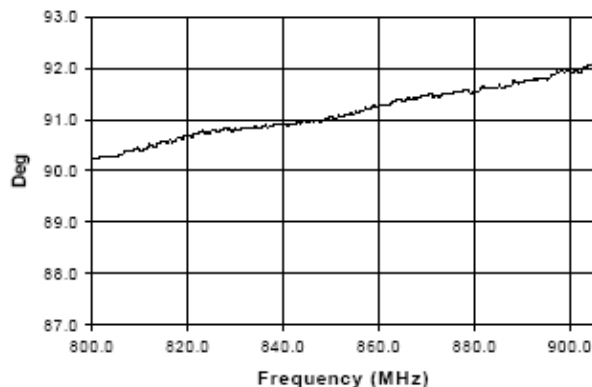

Lead-Free, SOT-26[†]

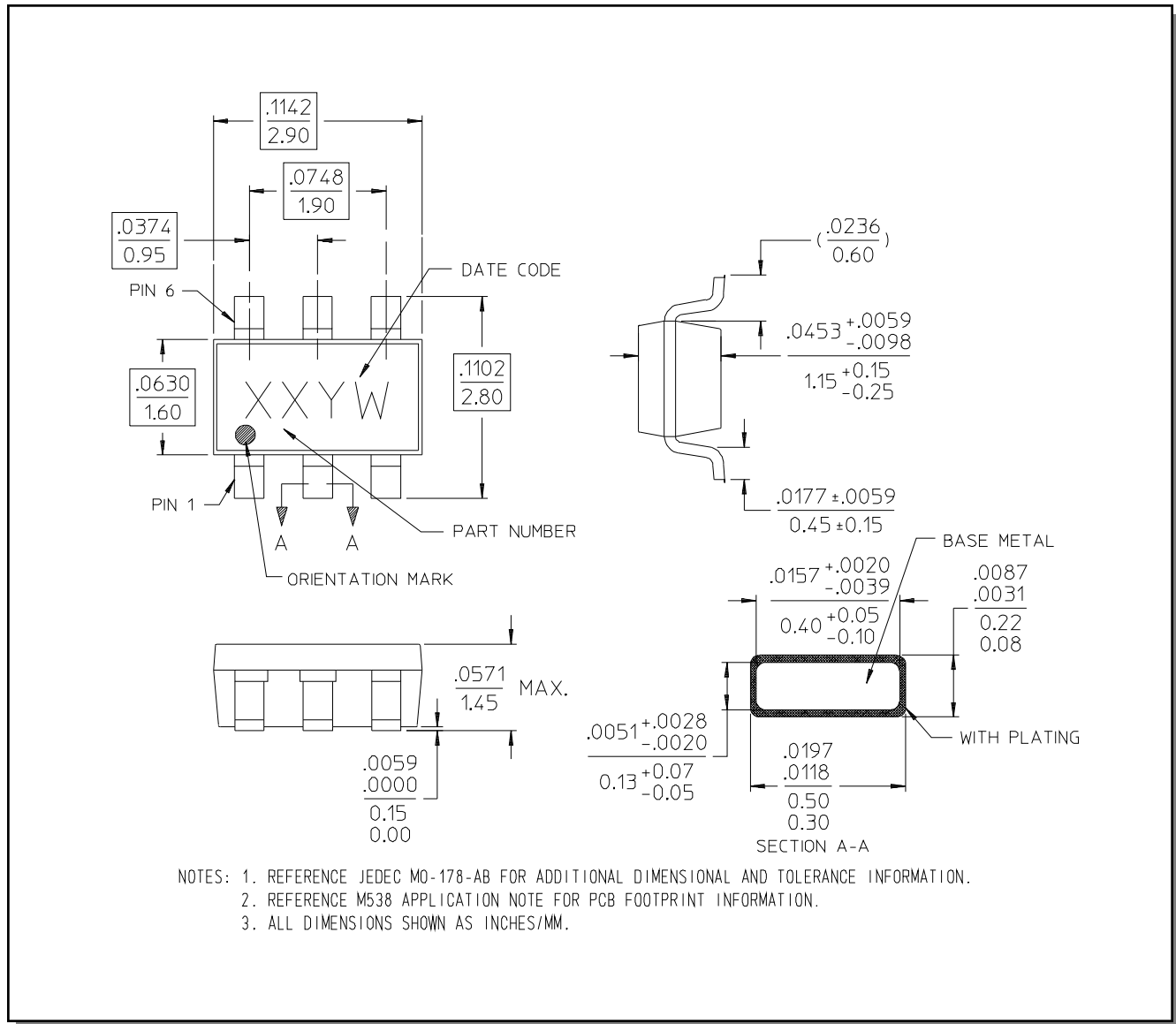

[†] Reference Application Note M538 for lead-free solder reflow recommendations.