

## Features

- Attenuation: 1.0dB Steps to 31dB
- Single Positive Supply
- Contains internal DC to DC converter
- Low DC Power Consumption
- Small Footprint, JEDEC Package
- Integral TTL Driver
- 50 ohm Impedance
- CSP-1 Package

## Description

M/A-COM's AT90-1263 is a GaAs FET 5-bit digital attenuator with integral TTL driver. Step size is 1.0 dB providing 31 dB total attenuation range. This device is in an FQFP-N plastic surface mount package. The AT90-1263 is ideally suited for use where accuracy, fast speed, very low power consumption and low costs are required. For dual supply designs without DC-DC converter noise, use AT90-0263.

## Functional Schematic

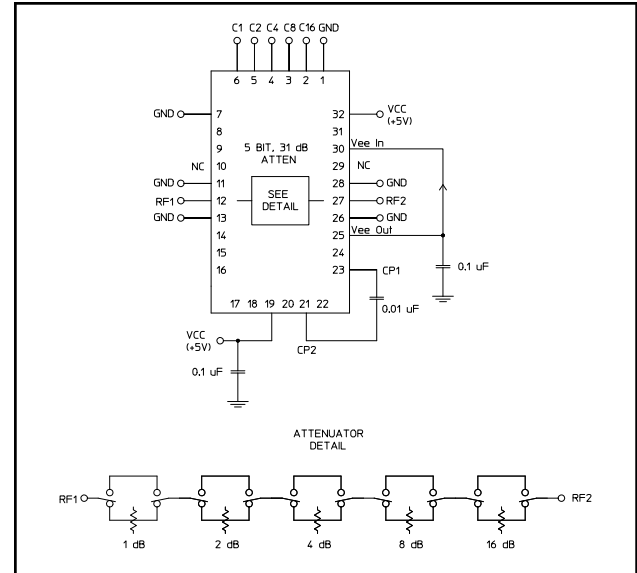

## Pin Configuration

Pin No.	Function	Pin No.	Function
1	GND	17	NC
2	C16	18	NC
3	C8	19	Vcc
4	C4	20	NC
5	C2	21	CP2
6	C1	22	NC
7	GND	23	CP1
8	NC	24	NC
9	NC	25	Vee <sup>2</sup>
10	NC <sup>1</sup>	26	GND
11	GND	27	RF2
12	RF1	28	GND
13	GND	29	NC <sup>1</sup>
14	NC	30	Vee <sup>2</sup>
15	NC	31	NC
16	NC	32	Vcc

1. Pins 10 & 29 must be isolated
2. The negative voltage Vee is produced internally and requires a 0.1µF cap to GND. Generated noise is typical of switching DC-DC Converters.
3. The exposed pad centered on the package bottom must be connected to RF and DC ground. (For PQFN Packages)

## Ordering Information

Part Number	Package
AT90-1263	Bulk Packaging
AT90-1263TR	1000 piece reel
AT90-1263-TB	Sample Test Board

Note: Reference Application Note M513 for reel size information.

**ADVANCED:** Data Sheets contain information regarding a product M/A-COM Technology Solutions is considering for development. Performance is based on target specifications, simulated results, and/or prototype measurements. Commitment to develop is not guaranteed.  
**PRELIMINARY:** Data Sheets contain information regarding a product M/A-COM Technology Solutions has under development. Performance is based on engineering tests. Specifications are typical. Mechanical outline has been fixed. Engineering samples and/or test data may be available. Commitment to produce in volume is not guaranteed.

• **North America** Tel: 800.366.2266 • **Europe** Tel: +353.21.244.6400  
 • **India** Tel: +91.80.4155721 • **China** Tel: +86.21.2407.1588  
 Visit [www.macomtech.com](http://www.macomtech.com) for additional data sheets and product information.

M/A-COM Technology Solutions Inc. and its affiliates reserve the right to make changes to the product(s) or information contained herein without notice.

**Electrical Specifications:  $T_A = 25^\circ\text{C}$ ,  $Z_0 = 50\Omega$**

Parameter	Test Conditions	Frequency	Units	Min	Typ	Max
Insertion Loss	—	DC - 3.0 GHz	dB	—	3.5	3.8
Attenuation Accuracy	Individual Bits 1-2-4-8-16 dB Any Combination of Bits 1 to 31 dB	DC - 3.0 GHz	dB	—	—	$\pm(3 + 5\%$ of atten setting)
		DC - 3.0 GHz	dB	—	—	$\pm(5 + 7\%$ of atten setting)
VSWR	Full Range	DC - 3.0 GHz	Ratio	—	2.0:1	2.2:1
Switching Speed	50% Cntl to 90%/10% RF 10% to 90% or 90% to 10%	—	ns	—	75	150
		—	ns	—	20	50
1 dB Compression	—	50 MHz	dBm	—	+21	—
		0.5 - 3.0 GHz	dBm	—	+24	—
Input $IP_3$	Two-tone inputs up to +5 dBm	50 MHz	dB	—	+35	—
		0.5-3.0 GHz	dB	—	+48	—
$V_{CC}$	—	—	V	4.75	5.0	5.25
$V_{IL}$ $V_{IH}$	LOW-level input voltage HIGH-level input voltage	—	V	0.0	—	0.8
		—	V	2.0	—	5.0
$I_{in}$ (Input Leakage Current)	$V_{in} = V_{CC}$ or GND	—	$\mu\text{A}$	-1.0	—	1.0
$I_{CC}^4$	$V_{CC}$ min to max, Logic "0" or "1"	—	mA	—	6	10
Turn-on Current <sup>5</sup>	For guaranteed start-up	—	mA	—	—	125
$\Delta I_{CC}$ (Additional Supply Current Per TTL Input Pin)	$V_{CC} = \text{Max}$ , $V_{cntrl} = V_{CC} - 2.1 \text{ V}$	—	mA	—	—	1.0
Switching Noise	Generated from DC-DC Converter with recommended capacitors	3.5 MHz	dBm	—	-93	—
Thermal Resistance $\theta_{jc}$	—	—	$^\circ\text{C/W}$	—	35	—

- During turn-on, the device requires an initial start up current ( $I_{CC}$ ) specified as "Turn-on Current". Once operational,  $I_{CC}$  will drop to the specified levels.
- The DC-DC converter is guaranteed to start in 100  $\mu\text{s}$  as long as the power supplies have the maximum turn-on current available for start up.

**Absolute Maximum Ratings<sup>6,7</sup>**

Parameter	Absolute Maximum
Max. Input Power 0.05 GHz 0.5 - 3.0 GHz	+27 dBm +34 dBm
$V_{CC}$	$-0.5\text{V} \leq V_{CC} \leq +6.0\text{V}$
$V_{in}^8$	$-0.5\text{V} \leq V_{in} \leq V_{CC} + 0.5\text{V}$
Operating Temperature	$-40^\circ\text{C}$ to $+85^\circ\text{C}$
Storage Temperature	$-65^\circ\text{C}$ to $+125^\circ\text{C}$

- Exceeding any one or combination of these limits may cause permanent damage to this device.
- M/A-COM does not recommend sustained operation near these survivability limits.
- Standard CMOS TTL interface, latch-up will occur if logic signal is applied prior to power supply.

**Recommended PCB Configuration<sup>9</sup>**

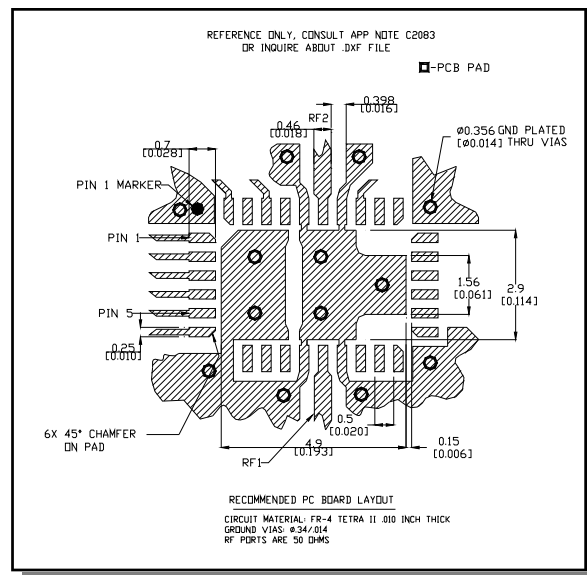

9. Application Note S2083 is available on line at [www.macom.com](http://www.macom.com)

• North America Tel: 800.366.2266 • Europe Tel: +353.21.244.6400  
 • India Tel: +91.80.4155721 • China Tel: +86.21.2407.1588  
 Visit [www.macomtech.com](http://www.macomtech.com) for additional data sheets and product information.

M/A-COM Technology Solutions Inc. and its affiliates reserve the right to make changes to the product(s) or information contained herein without notice.

## Handling Procedures

Please observe the following precautions to avoid damage:

## Static Sensitivity

Gallium Arsenide Integrated Circuits are sensitive to electrostatic discharge (ESD) and can be damaged by static electricity. Proper ESD control techniques should be used when handling these devices.

## Moisture Sensitivity

The MSL rating for this part is defined as Level 2 per IPC/JEDEC J-STD-020. Parts shall be stored and/or baked as required for MSL Level 2 parts.

## Typical Performance Curves

### Insertion Loss

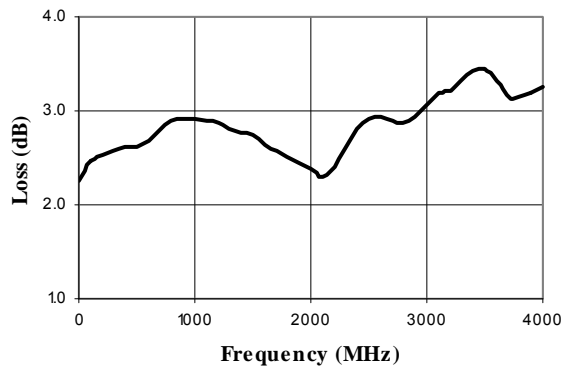

### Attenuation Error, 1 dB Bit

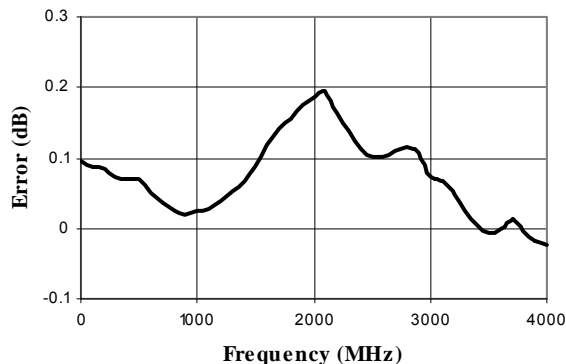

## Truth Table (Digital Attenuator)

C16	C8	C4	C2	C1	Attenuation
0	0	0	0	0	Loss, Reference
0	0	0	0	1	1.0 dB
0	0	0	1	0	2.0 dB
0	0	1	0	0	4.0 dB
0	1	0	0	0	8.0 dB
1	0	0	0	0	16.0 dB
1	1	1	1	1	31.0 dB

0 = TTL Low; 1 = TTL High

### VSWR @ Insertion Loss

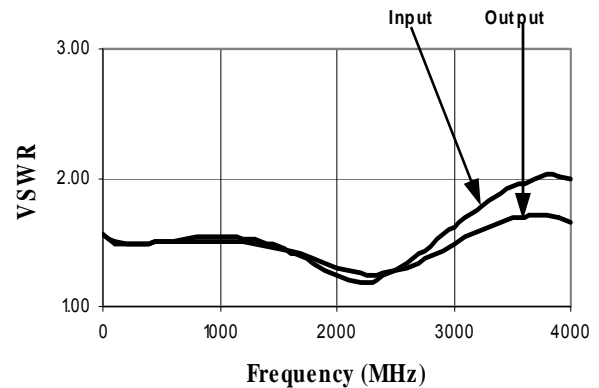

### Attenuation Error, 2 dB Bit

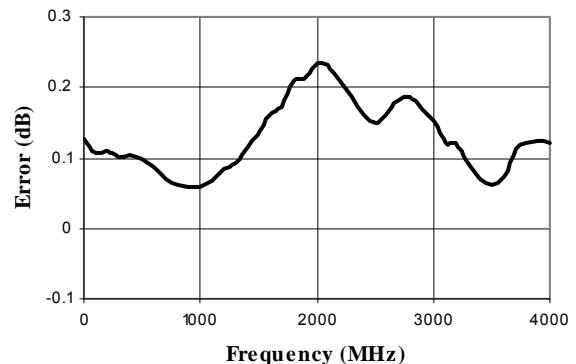

## Typical Performance Curves

Attenuation Error, 4 dB Bit

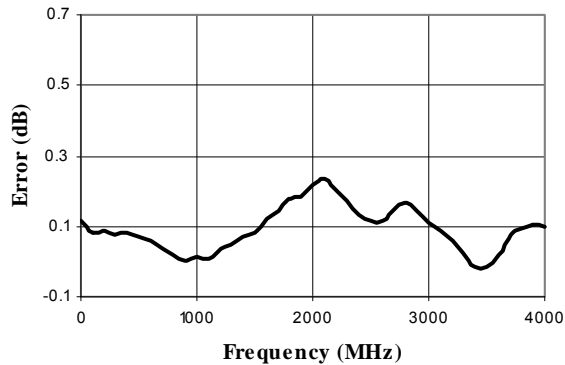

Attenuation Error, 8 dB Bit

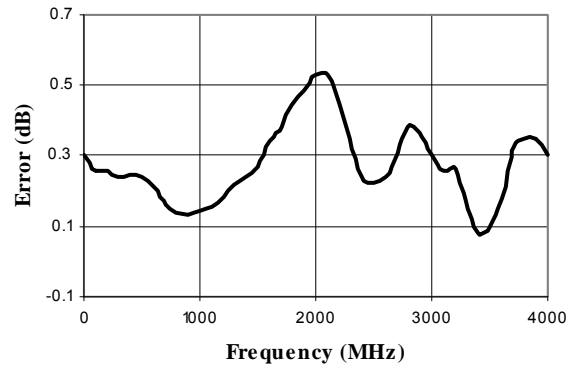

Attenuation Error, 16 dB Bit

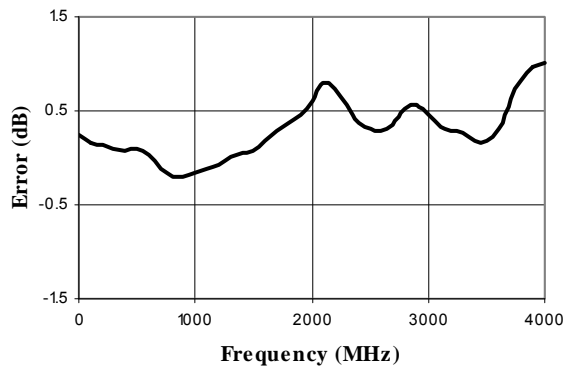

Attenuation Error, Max. Attenuation

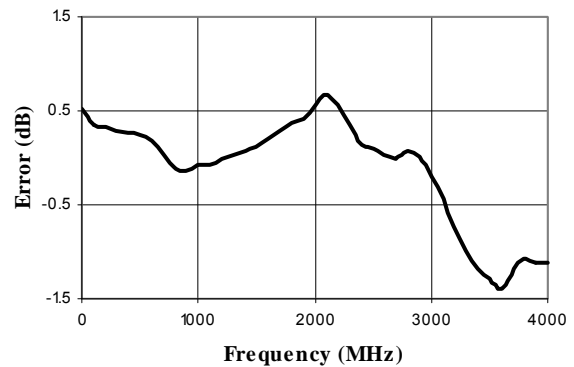

VSWR, 1 dB Bit

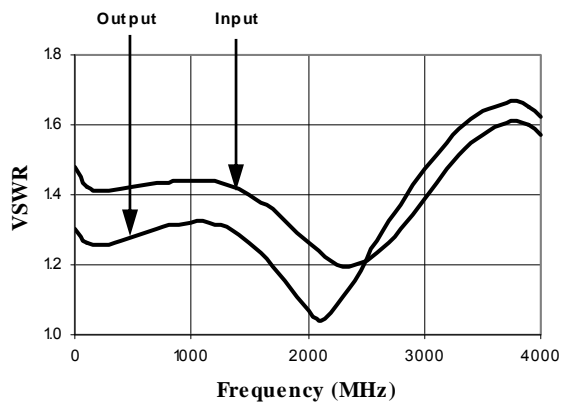

VSWR, 2 dB Bit

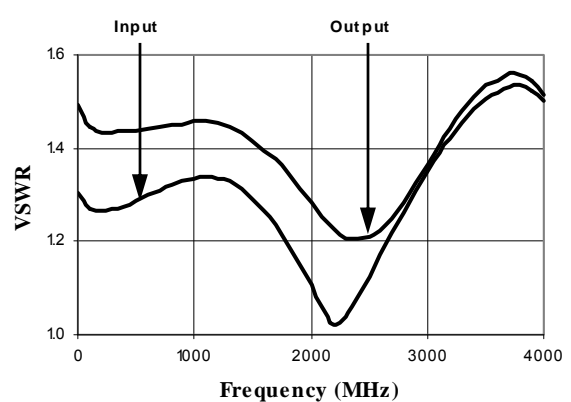

## Typical Performance Curves

**VSWR, 4 dB Bit**

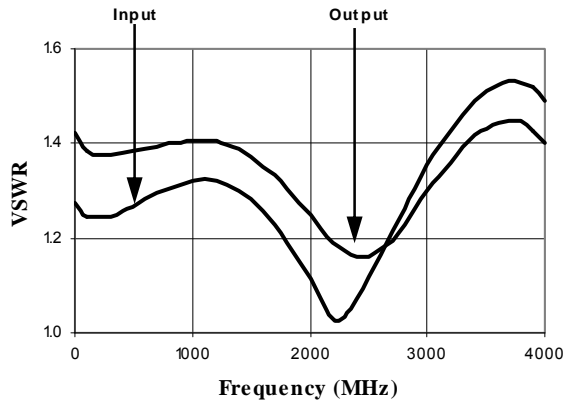

**VSWR, 8 dB Bit**

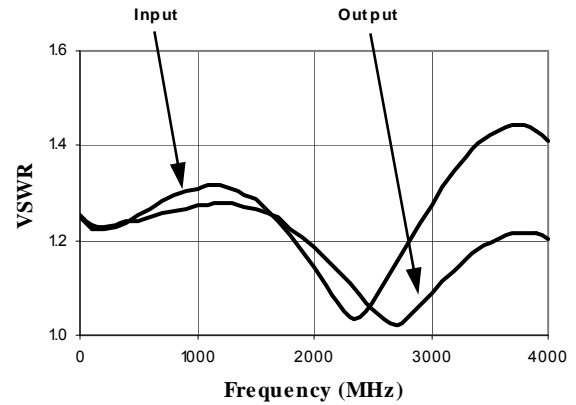

**VSWR, 16 dB Bit**

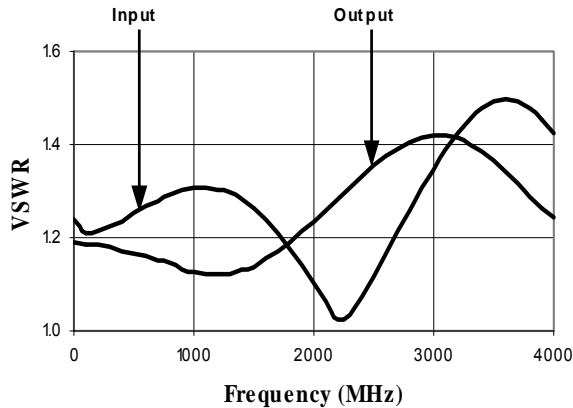

**VSWR, Maximum Attenuation**

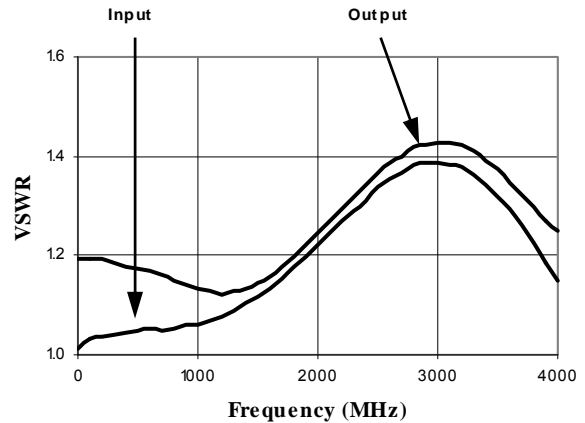

## CSP-1, 4 x 6 mm, 32-lead PQFN†

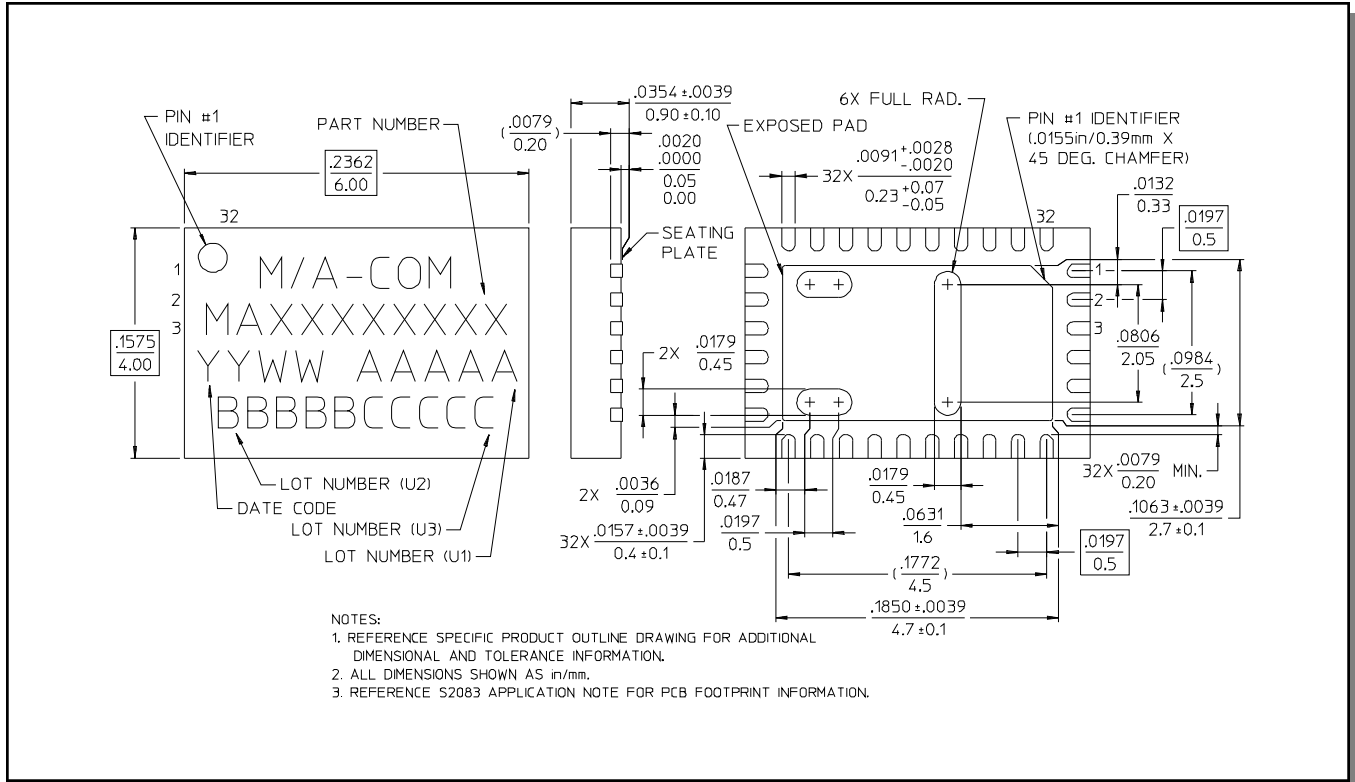

† Reference Application Note M538 for lead-free solder reflow recommendations.