

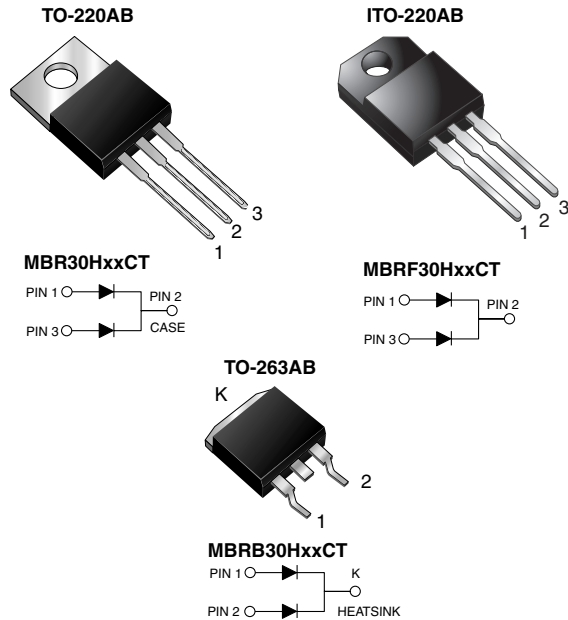

## Dual Common-Cathode Schottky Rectifier

High Barrier Technology for Improved High Temperature Performance



### FEATURES

- Guardring for overvoltage protection
- Lower power losses, high efficiency
- Low forward voltage drop
- Low leakage current
- High forward surge capability
- High frequency operation
- Meets MSL level 1, per J-STD-020, LF maximum peak of 245 °C (for TO-263AB package)
- Solder dip 260 °C, 40 s (for TO-220AB and ITO-220AB package)
- Component in accordance to RoHS 2002/95/EC and WEEE 2002/96/EC



**RoHS**  
 COMPLIANT

### TYPICAL APPLICATIONS

For use in low voltage, high frequency rectifier of switching mode power supplies, freewheeling diodes, dc-to-dc converters or polarity protection application.

### MECHANICAL DATA

**Case:** TO-220AB, ITO-220AB, TO-263AB

Epoxy meets UL 94V-0 flammability rating

**Terminals:** Matte tin plated leads, solderable per J-STD-002 and JESD22-B102

E3 suffix for consumer grade, meets JESD 201 class 1A whisker test, HE3 suffix for high reliability grade (AEC-Q101 qualified), meets JESD 201 class 2 whisker test

**Polarity:** As marked

**Mounting Torque:** 10 in-lbs maximum

PRIMARY CHARACTERISTICS	
$I_{F(AV)}$	2 x 15 A
$V_{RRM}$	35 V to 60 V
$I_{FSM}$	150 A
$V_F$	0.56 V, 0.59 V
$I_R$	80 $\mu$ A, 60 $\mu$ A
$T_J$ max.	175 °C

MAXIMUM RATINGS ( $T_C = 25$ °C unless otherwise noted)						
PARAMETER	SYMBOL	MBR30H35CT	MBR30H45CT	MBR30H50CT	MBR30H60CT	UNIT
Maximum repetitive peak reverse voltage	$V_{RRM}$	35	45	50	60	V
Working peak reverse voltage	$V_{RWM}$	35	45	50	60	V
Maximum DC blocking voltage	$V_{DC}$	35	45	50	60	V
Max. average forward rectified current (Fig. 1)	$I_{F(AV)}$	total device per diode		30	15	A
Non-repetitive avalanche energy per diode at 25 °C, $I_{AS} = 4$ A, $L = 10$ mH	$E_{AS}$			80		mJ
Peak forward surge current 8.3 ms single half sine-wave superimposed on rated load per diode	$I_{FSM}$			150		A
Peak repetitive reverse surge current per diode at $t_p = 2.0$ $\mu$ s, 1 kHz	$I_{RRM}$	1.0		0.5		A
Peak non-repetitive reverse energy (8/20 $\mu$ s waveform)	$E_{RSM}$	25		20		mJ

# New Product

## MBR(F,B)30H35CT thru MBR(F,B)30H60CT



Vishay General Semiconductor

MAXIMUM RATINGS (T <sub>C</sub> = 25 °C unless otherwise noted)						
PARAMETER	SYMBOL	MBR30H35CT	MBR30H45CT	MBR30H50CT	MBR30H60CT	UNIT
Electrostatic discharge capacitor voltage human body model: C = 100 pF, R = 1.5 kΩ	V <sub>C</sub>	25				kV
Voltage rate of change (rated V <sub>R</sub> )	dV/dt	10 000				V/μs
Operating junction temperature range	T <sub>J</sub>	- 65 to + 175				°C
Storage temperature range	T <sub>STG</sub>	- 65 to + 175				°C
Isolation voltage (ITO-220AB only) from terminal to heatsink t = 1 min	V <sub>AC</sub>	1500				V

ELECTRICAL CHARACTERISTICS (T <sub>C</sub> = 25 °C unless otherwise noted)								
PARAMETER	TEST CONDITIONS		SYMBOL	MBR30H35CT MBR30H45CT		MBR30H50CT MBR30H60CT		UNIT
				TYP.	MAX.	TYP.	MAX.	
Maximum instantaneous forward voltage per diode <sup>(1)</sup>	I <sub>F</sub> = 15 A	T <sub>J</sub> = 25 °C	V <sub>F</sub>	-	0.62	-	0.68	V
	I <sub>F</sub> = 15 A	T <sub>J</sub> = 125 °C		0.49	0.56	0.55	0.59	
	I <sub>F</sub> = 30 A	T <sub>J</sub> = 25 °C		-	0.73	-	0.83	
	I <sub>F</sub> = 30 A	T <sub>J</sub> = 125 °C		0.62	0.67	0.68	0.71	
Maximum reverse current at rated V <sub>R</sub> per diode <sup>(2)</sup>		T <sub>J</sub> = 25 °C T <sub>J</sub> = 125 °C	I <sub>R</sub>	- 5.0	80 15	- 4.0	60 15	μA mA

**Notes:**

- (1) Pulse test: 300 μs pulse width, 1 % duty cycle
- (2) Pulse test: Pulse width ≤ 40 ms

THERMAL CHARACTERISTICS (T <sub>C</sub> = 25 °C unless otherwise noted)					
PARAMETER	SYMBOL	MBR	MBRF	MBRB	UNIT
Thermal resistance, junction to case per diode	R <sub>θJC</sub>	1.5	4.5	1.5	°C/W

ORDERING INFORMATION					
PACKAGE	PREFERRED P/N	UNIT WEIGHT (g)	PACKAGE CODE	BASE QUANTITY	DELIVERY MODE
TO-220AB	MBR30H45CT-E3/45	1.85	45	50/tube	Tube
ITO-220AB	MBRF30H45CT-E3/45	1.99	45	50/tube	Tube
TO-263AB	MBRB30H45CT-E3/45	1.35	45	50/tube	Tube
TO-263AB	MBRB30H45CT-E3/81	1.35	81	800/teel	Tape and reel
TO-220AB	MBR30H45CTHE3/45 <sup>(1)</sup>	1.85	45	50/tube	Tube
ITO-220AB	MBRF30H45CTHE3/45 <sup>(1)</sup>	1.99	45	50/tube	Tube
TO-263AB	MBRB30H45CTHE3/45 <sup>(1)</sup>	1.35	45	50/tube	Tube
TO-263AB	MBRB30H45CTHE3/81 <sup>(1)</sup>	1.35	81	800/teel	Tape and reel

**Note:**

- (1) Automotive grade AEC-Q101 qualified



**RATINGS AND CHARACTERISTICS CURVES**

( $T_A = 25\text{ }^\circ\text{C}$  unless otherwise noted)

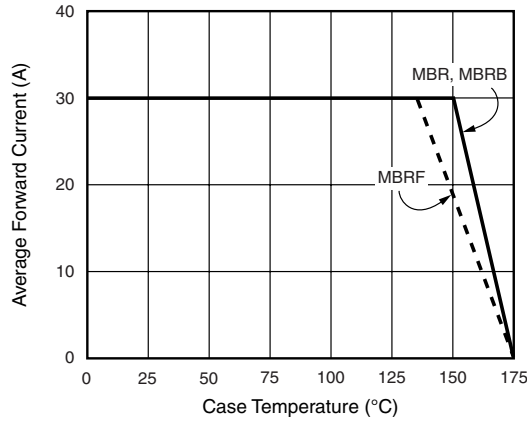

Figure 1. Forward Derating Curve

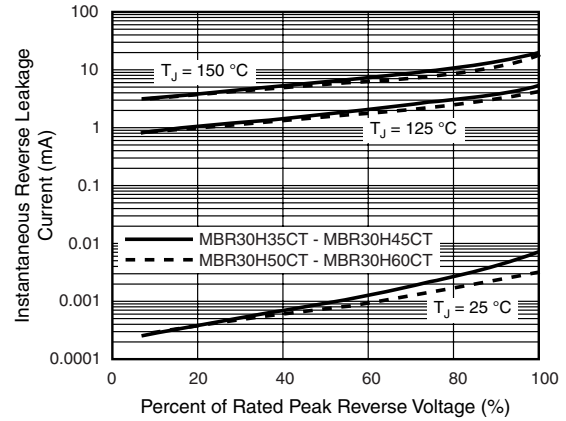

Figure 4. Typical Reverse Characteristics Per Diode

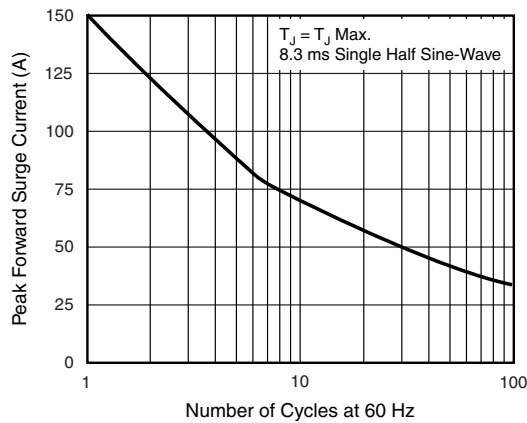

Figure 2. Maximum Non-Repetitive Peak Forward Surge Current Per Diode

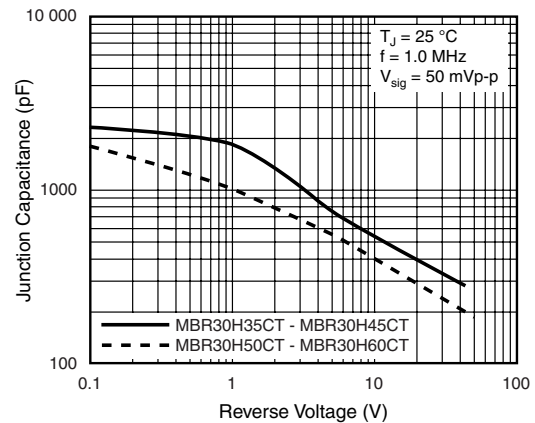

Figure 5. Typical Junction Capacitance Per Diode

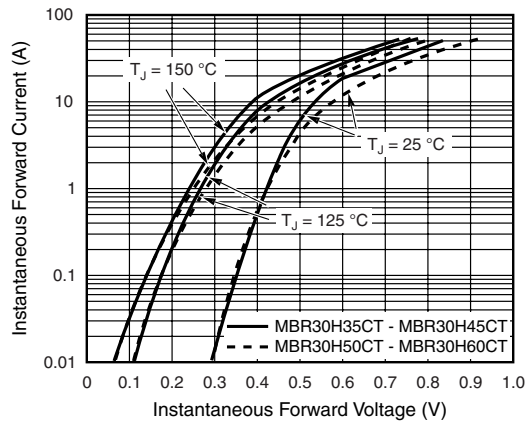

Figure 3. Typical Instantaneous Forward Characteristics Per Diode

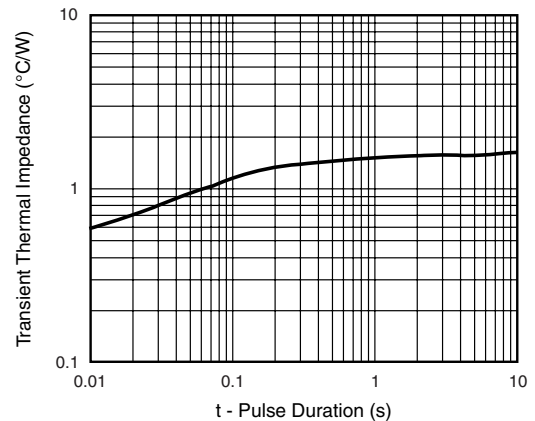

Figure 6. Typical Transient Thermal Impedance Per Diode

# New Product MBR(F,B)30H35CT thru MBR(F,B)30H60CT

Vishay General Semiconductor



## PACKAGE OUTLINE DIMENSIONS in inches (millimeters)

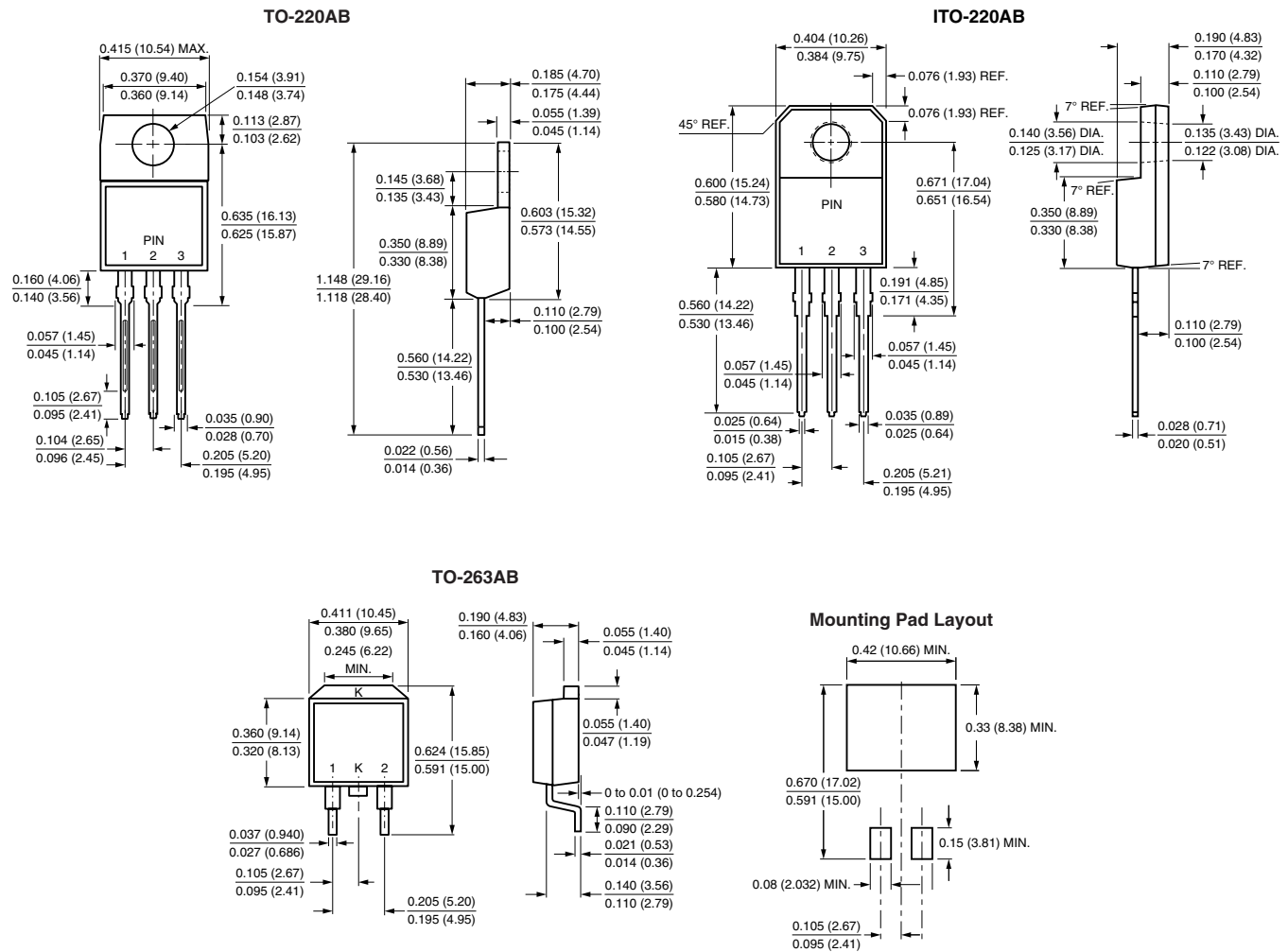



## Disclaimer

All product specifications and data are subject to change without notice.

Vishay Intertechnology, Inc., its affiliates, agents, and employees, and all persons acting on its or their behalf (collectively, "Vishay"), disclaim any and all liability for any errors, inaccuracies or incompleteness contained herein or in any other disclosure relating to any product.

Vishay disclaims any and all liability arising out of the use or application of any product described herein or of any information provided herein to the maximum extent permitted by law. The product specifications do not expand or otherwise modify Vishay's terms and conditions of purchase, including but not limited to the warranty expressed therein, which apply to these products.

No license, express or implied, by estoppel or otherwise, to any intellectual property rights is granted by this document or by any conduct of Vishay.

The products shown herein are not designed for use in medical, life-saving, or life-sustaining applications unless otherwise expressly indicated. Customers using or selling Vishay products not expressly indicated for use in such applications do so entirely at their own risk and agree to fully indemnify Vishay for any damages arising or resulting from such use or sale. Please contact authorized Vishay personnel to obtain written terms and conditions regarding products designed for such applications.

Product names and markings noted herein may be trademarks of their respective owners.